

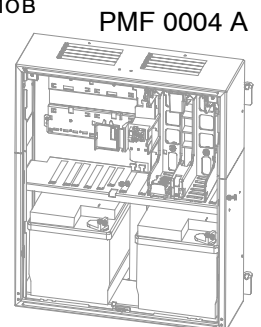

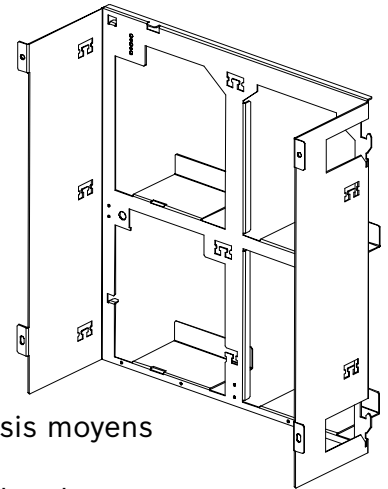

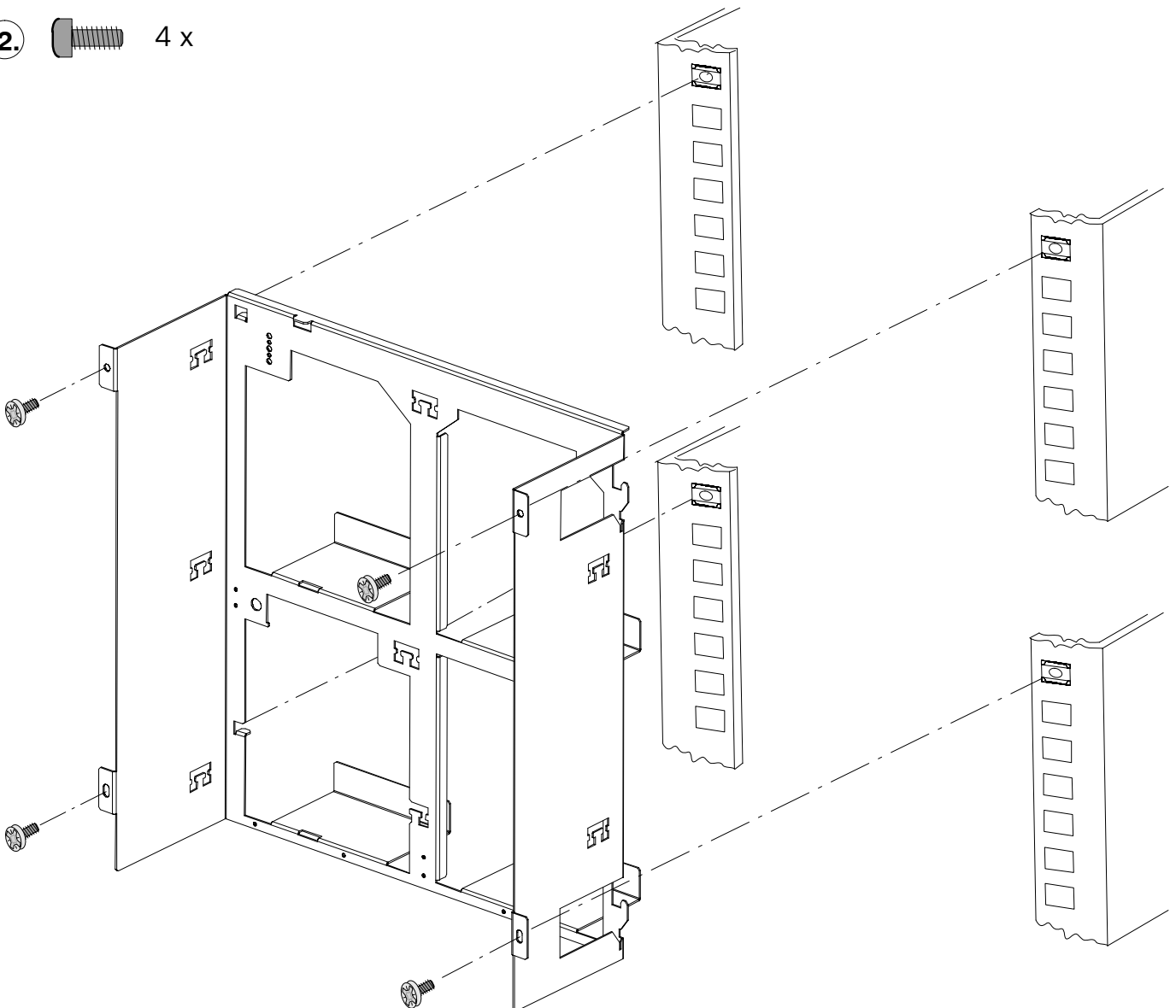

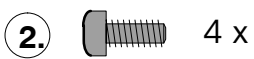

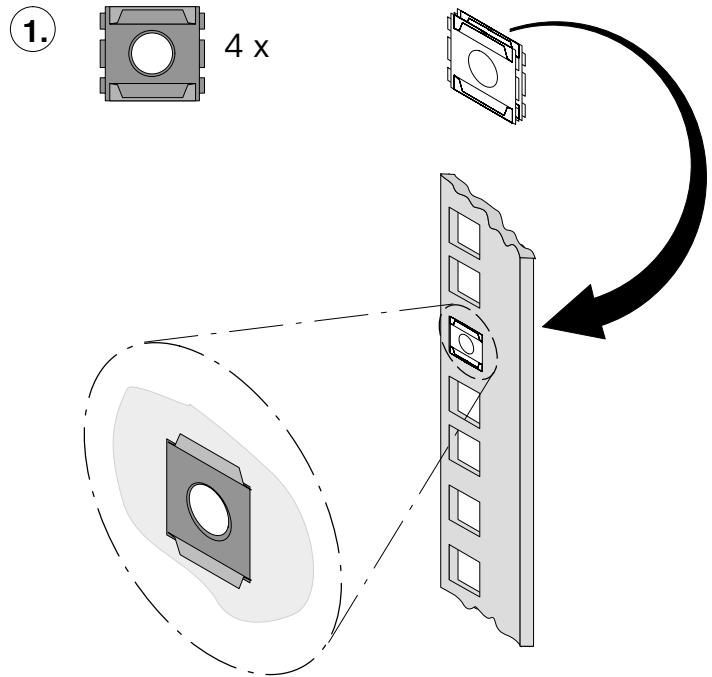
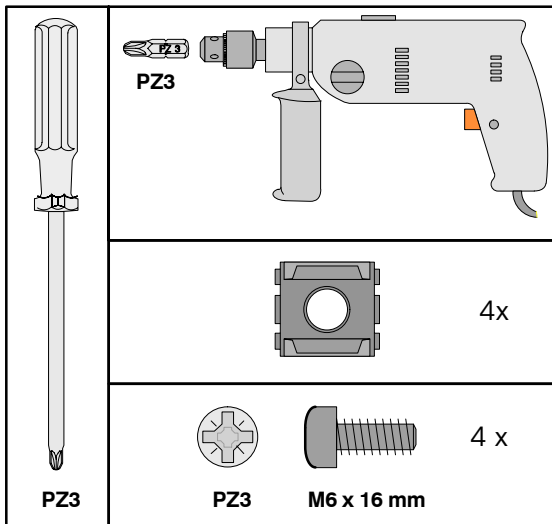













FRM 0019 A
4.998.139.499

- AL** **Pershkrimi i pajisjes / Manual i instalimit**
Kompleti i instalimit të shasisë, për folenë e telajos së mesme
- BG** **Описание на продукта / Инструкция за монтаж**
Набор за инсталиране в шкаф
- CZ** **Popis produktu / Instalační manuál**
Souprava pro instalaci do 19" racku, kryt se středním rámem
- D** **Produktbeschreibung / Montageanleitung**
Einbausatz 19", für mittlere Rahmenmontage-Gehäuse
- DK** **Produktbeskrivelse / Installationsmanual**
Rackmonteringsæt, til montering af mellemstore rammer
- E** **Descripción del Producto / Manual de Instalación**
Juego de instalación de bastidor de 19"
- EST** **Toote kirjeldus / Monteerimisjuhised**
Seadmekapi paigaldamise komplekt
- F** **Description de produit / Manuel d'installation**
Kit d'installation sur bâti 19", pour boîtiers à installer sur châssis moyens
- FIN** **Tuotekuvaus / Asennusohjeet**
Tuuman telineen asennussarja, keskikokoisen telineen asennuskotelo
- GB** **Product description / Installation manual**
19" Rack installation kit, for medium frame installation housings
- GR** **Περιγραφή προϊόντος / Οδηγίες συναρμολόγησης**
Κιτ εγκατάστασης ραφιού 19", για περίβλημα εγκατάστασης μεσαίου πλαισίου
- H** **Termékleírás / Telepítési kézikönyv**
Szerelő készlet 19"-os konzolba közepes méretű készülékhez
- HR** **Opis proizvoda / Priručnik za instaliranje**
Pribor za montažu police za srednji okvir kućišta za ugradnju
- I** **Descrizione prodotto / Manuale di installazione**
Kit di installazione rack da 19 pollici, per contenitore installazione comice media
- LT** **Gaminio aprašymas / Surinkimo instrukcija**
Montavimo rėme rinkinys, vidutinės apimties
- LV** **Izstrādājuma apraksts / Montāžas norādījumi**
Statnes uzstādīšanas komplekts vidēja izmēra rāmja apvalkam
- N** **Produktbeskrivelse / Monteringsinstruksoner**
Installeringssett for 19-tommers stativ, for mellomstort hus med montering i ramme
- NL** **Productomschrijving / Installatiehandleiding**
19" rek-installatiekit, voor behuizing voor normaal kozijn
- P** **Descrição de Produto / Manual de Instalação**
Kit de instalação de bastidor de 19 pol. para estrutura de instalação média
- PL** **Opis produktu / Instrukcja instalacji**
Zestaw do montażu w szafie typu Rack 19"
- RO** **Prospecțe / Manual de Instalare**
Kit de instalare în rack de 19", pentru carcasă cu montare pe cadru mediu
- RUS** **Техническое описание / Инструкция по установке**
Установочный комплект зубчатых реек для корпуса средней стойки 19 дюймов
- S** **Produkt beskrivning / Installation manual**
19-tums rackinstallationssett, för mediumramms installationshölje
- SCG** **Opis proizvoda / Instalacijski priručnik**
19" pribor za montažu police, za ugradnju na srednji okvir kućišta
- SLO** **Opis izdelka / Priročnik za montažo**
Komplet za namestitev v 19-palčno omarico
- TR** **Ürün tanımı / Kurulum kılavuzu**
19" Raf kurma seti, orta çerçeve montajı muhafazası için





AL	 RREZIK	RREZIK GODITJE NGA TENSION! Prekja e pjesëve nën tension mund të jetë vdekjeprurëse. Shkëputni furnizimin me energji përpara se të lidhni pajisjet!
BG	 ОПАСНОСТ	ОПАСНОСТ ОТ ТОКОВ УДАР! Опасност за живота при докосване на тоководещи части. Преди довършителните работи да се изключи токът!
CZ	 NEBEZPEČÍ	NEBEZPEČÍ ÚRAZU ELEKTRICKÝM PROUDEM! Nebezpečí ohrožení života při dotyku vodivých dílů. Před připojováním zařízení odpojte od zdroje napětí!
D	 GEFAHR	GEFAHR EINES STROMSCHLAGS! Lebensgefahr bei Berührung stromführender Teile. Vor Installationsarbeiten die Stromzufuhr abschalten!
DK	 FARE	FARE FOR ELEKTRISK STØD! Livsfare ved berøring af strømførende dele. Slå strømmen fra, før der tilsluttes udstyr!
E	 PELIGRO	¡RIESGO DE UNA DESCARGAS ELÉCTRICA! Peligro de muerte al entrar en contacto con piezas que conduzcan corriente. Desconectar la alimentación antes de conectar el equipo!
EST	 OHT	ELEKTRILÖÖGI OHT! Elektrivoolu all olevate detailide puudutamise on eluohulik. Katkestage toide enne seadme ühendamist!
F	 DANGER	RISQUE DE CHOC ÉLECTRIQUE ! Danger de mort en cas de contact avec les éléments sous tension. Débrancher l'alimentation avant de connecter l'équipement.
FIN	 VAARA	SÄHKÖISKUN VAARA! Sähköä johtavien osien koskettaminen voi aiheuttaa hengenvaaran. Katkaise virta ennen laitteiden liittämistä!
GB	 DANGER	RISK OF ELECTRIC SHOCK ! Danger of life with contact of live parts and wires. Disconnect power before connecting equipment!
GR	 KINΔYΝΟΣ	ΚΙΝΔΥΝΟΣ ΗΛΕΚΤΡΟΠΛΗΞΙΑΣ! Θανάσιμος κίνδυνος κατά την επαφή με τα ρευματοφόρα εξαρτήματα. Αποσυνδέστε την ισχύ πριν συνδέσετε το εξάρτημα!

H	 FIGYELEM	ÁRAMÜTÉSVESZÉLY! Az áramot vezető alkatrészek érintése életveszélyes. Valamely felszerelés csatlakoztatása előtt áramtalanítsa!
HR	 OPASNOST	OPASNOST OD STRUJNOG UDARA! Opasnost po život pri kontaktu s delovima pod naponom. Isključite napajanje prije priključivanja opreme!
I	 PERICOLO	PERICOLO DI SCOSSA ELETTRICA! Pericolo di morte attraverso il contatto con elementi conduttori di elettricità. Interrompere l'alimentazione prima di collegare le attrezzature!
LT	 PAVOJUS	ELEKTROS SMŪGIO PAVOJUS! Prisilietus prie dalių, kuriomis teka elektros srovė, gresia pavojus gyvybei. Prieš jungdami įrangą, išjunkite maitinimą iš tinklo!
LV	 BRIESMAS	STRĀVAS TIRECIENA DRAUDI! Pieskaršanās strāvu vadošām daļām apdraud dzīvību. Pirms pievienot iekārtas, atvienojiet strāvas padevi!
N	 FARE	FARE FOR ELEKTRISK STØT! Berøring av de strømførende delene kan medføre livsfare. Koble fra strømmen før du kobler til utstyret!
NL	 GEVAAR	GEVAAR VAN EEN STROOMSTOOT! Het aanraken van stroomgeleidende onderdelen is levensgevaarlijk. Sluit de voeding af voordat u apparatuur aansluit!
P	 PERIGO	PERIGO DE ELECTROCUSSÃO! Perigo de vida ao tocar nas peças condutoras de corrente. Desligue a alimentação antes de ligar o equipamento!
PL	 NIEBEZPIECZEŃSTWO	RYZYKO PORAŻENIA PRĄDEM ELEKTRYCZNYM! Śmiertelne niebezpieczeństwo przy dotknięciu części pod napięciem. Przed dołączeniem urządzeń należy odłączyć zasilanie!
RO	 PERICOL	PERICOL DE ELECTROCUTARE! Pericol de moarte la atingerea părților purtătoare de curent! Întrerupeți alimentarea înainte de a conecta echipamentul!
RUS	 ОПАСНОСТ	ОПАСНОСТЬ ПОРАЖЕНИЯ ЭЛЕКТРИЧЕСКИМ ТОКОМ! опасность для жизни при соприкосновении с токопроводящими деталями. Перед присоединением оборудования отсоединить питание!

S

 RISK	RISK FÖR STRÖMÖVERSLAG!
	Livsfara vid beröring av strömförande delar. Koppla bort strömmen innan du ansluter utrustning!

SCG

 OPASNOST	OPASNOST OD STRUJNOG UDARA!
	Opasnost po život u kontaktu sa delovima pod naponom. Isključite napajanje prije priključivanja opreme!

SLO

 NEVARNOST	NEVARNOST ELEKTRIČNEGA ŠOKA!
	Dotik delov pod električno napetostjo je smrtno nevaren. Pred priključitvijo opreme izklopite napajanje!

TR

 TEHLİKE	ELEKTRİK ÇARPMASI TEHLİKESİ!
	Elektrik iletken parçalar dokunulması durumunda hayati tehlike. Donanımı bağlamadan önce güç bağlantısını kesin!

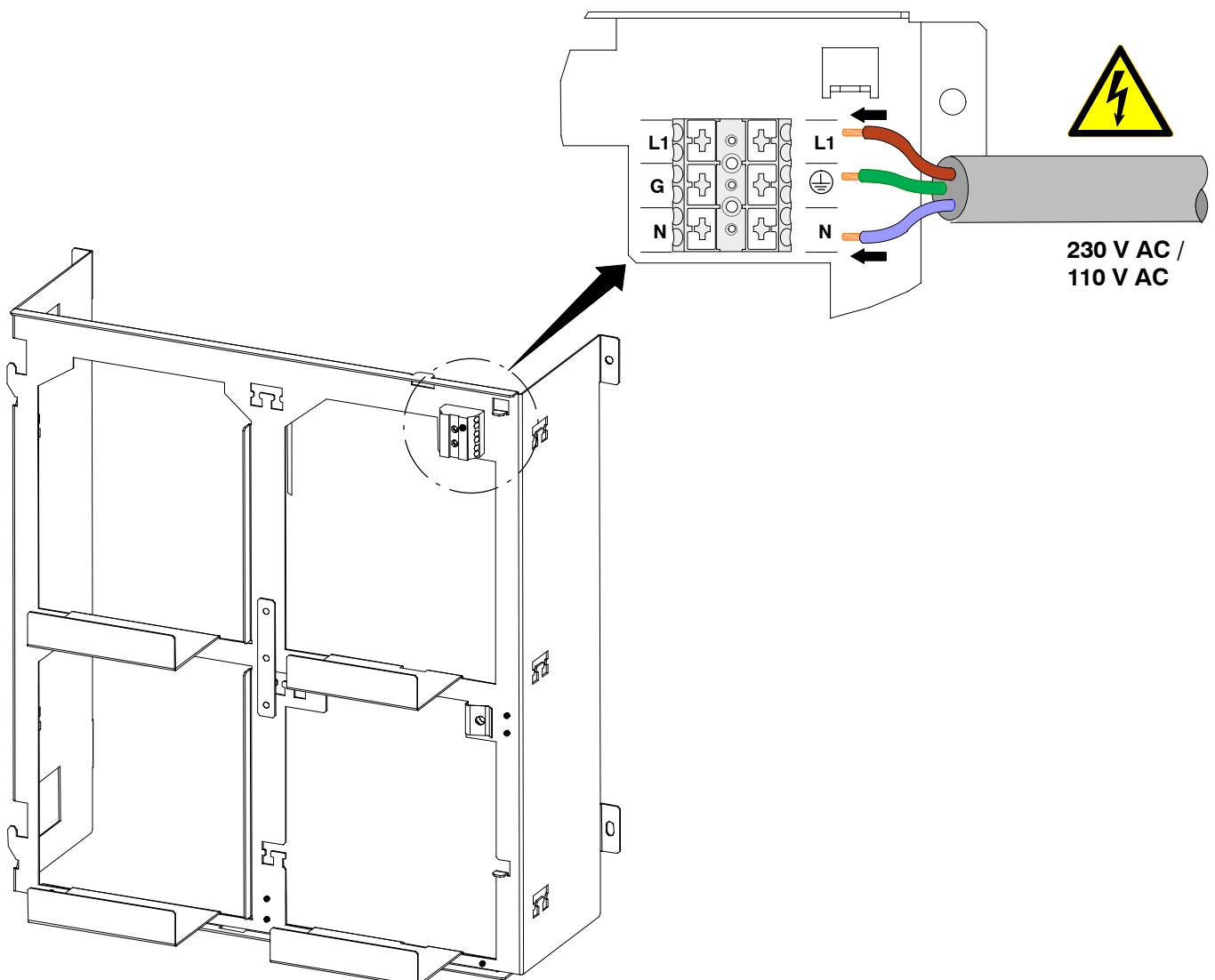



Bosch Sicherheitssysteme GmbH
Robert-Koch-Straße 100
D-85521 Ottobrunn

Info-Service

www.bosch-sicherheitssysteme.de
info.service@de.bosch.com