

ZETTLER

ZETTLER
Fire Detection
UK Product
Catalogue

Your ideas are a reality to us

A pencil is positioned diagonally across the frame, pointing towards the bottom left. The background is a blue-tinted image of a floor plan or architectural drawing, with various rooms and corridors outlined. The overall aesthetic is professional and focused on design and planning.

ZETTLER, is a leading brand of fire detection, security, and care communications products in the European market. The ZETTLER fire detection product line includes a wide range MZX TECHNOLOGY EN54 CPR approved fire detection products carrying approvals and cross-listings, including VdS and NF, for all European countries. The ZETTLER care communications product line is a technology leader providing the latest IP based Nursecall, Emergency Call, Communication and Management solutions for care homes, hospitals, prisons, and related markets. The ZETTLER product lines are available through ZETTLER dealers as well as many Tyco offices around the world. For more information, visit www.zettlerfire.com

Index

Addressable Systems

- Panels
- Detectors & Bases
- Input/Output Modules
- Remote Service
- Callpoints
- Ancillaries
- Software & Programming Tools
- Spare Parts

Conventional Systems

- Panels
- Detectors
- Detector Bases
- Callpoints & Ancillaries

Sounders, Bells and Beacons

- Loop Powered Sounders and Beacons
- Bells
- Sounders
- EN54-23 Beacons
- Beacons

Special Detection

- Beam Detection
FIRERAY & OSID
- Aspirating Smoke Detection
VESDA
- Linear Heat Detection
MZX SensorLaser Plus

Network and Graphics

- TXG Tyco Expert Graphics
- MZXNet TLI800EN
- CCU Modules
- BACNet Interface

Hazardous Area Protection

- Flame Detectors
- Addressable Detection
- Conventional Detection
- Sounders and Beacons

Detector Test Equipment

- Test Equipment Range

Emergency Voice Communication (EVC)

- Omnicare Loop Wired EVC
- CARE2 Radial Wired EVC

System Accessories

- Batteries
- Power Supplies
- Door Release Equipment
- Auxiliary Interface Relays
- Fire Resistant Cable

Further Reading

ZETTLER Fire Detection Consultants Guide

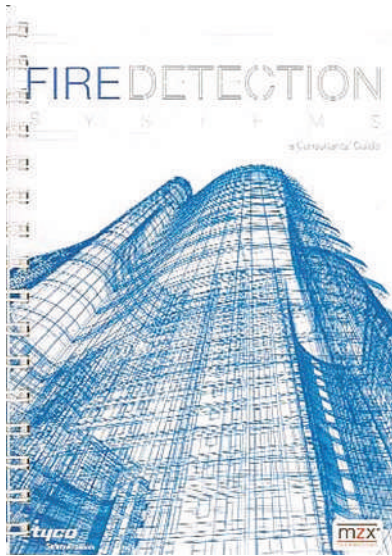

A Fire Detection System Consultants Guide for consultants designing systems to BS5839-1 and an introduction to the suite of EN54 standards.

Features

- Selecting the category of protection and coverage
- How to configure detector zones and alarm zones within premises
- Which type of fire detection system?
- Detector suitability
- Detector coverage
- Manual break glass call points
- Limitation of false alarms
- Means of giving warning to occupants
- Control and indicating equipment
- Power supplies
- Cabling considerations
- Communication with the fire service
- System installation
- Documentation
- Standards and Specifications
- Associated Ancillary Equipment
- Networking and Graphics
- Installation
- Commissioning
- Training
- Maintenance

Order Codes

CGUK-01

Consultants Guide



Addressable Systems

Panels

Detectors & Bases

Input/Output Modules

Remote Service

Callpoints

Ancillaries

Software & Programming Tools

Spare Parts

Addressable Systems

MZX technology embraces the best in both analogue and digital electronics to provide fast and accurate fire detection. Extensive loop addressing and communication over a 2km loop using digital protocol to a central processing location, provides reliability and a lifetime of economy. A comprehensive range of sensors, sounders and beacons, ancillaries and call points ensure there are no compromises when designing systems. Progressive software development keeps pace with new technology and a comprehensive range of available spares together with backwards compatibility ensures long life and the maximum return on investment.

Control Panels

The MZX range of addressable panels provides a perfect fit for all sizes of system from a single panel and 125 devices to a network of 99 panels and up to 99000 devices. A simple yet powerful user interface is common to all panels, modular construction allows upgrades and extensions, and a range of repeater options provides for those occasions when small and discreet is key. Both surface and flush mount versions are available and a removable chassis plate facilitates an easy and safe installation. An operator training CD ROM is provided with every panel allowing on-going training for those who need to know.

Detectors

MZX sensors and multisensors integrate the best in sensor technology with powerful software that provides fire detection to suit all risks and all possible scenarios. The software allows the detection to be optimised to suit the building, its occupancy and therefore the risk. Changing detection modes, changing sensitivity and changing cause and effect are all features available under the day/night mode operator function key. Detection technologies include Carbon Monoxide, Smoke, Heat and Flame, some of which are combined in powerful algorithms to provide fast detection and reduce unwanted alarms, even in the harshest of environments. Two different ranges provide options with and without short circuit isolators and two way infra-red communications. A choice of ten standard colours is available and detectors can be fitted to a range of sounder/beacon bases.

Remote Service

All property protection systems should be connected to a remote monitoring centre, especially if they are not continuously occupied. Simple communicators are only 1 way & situations often require a key holder's attendance in order to investigate prior to an engineer being despatched. Remote connections can be made using the Internet whereby not only is the remote centre capable of receiving signals, but also has the ability to interrogate the system on the premises, gain access to & take short term remedial measures such as isolating a faulty device. The system monitors for both alarms & faults, is capable of detecting suppression systems that have discharged as well as monitoring & reporting other vital functions. The system also has the capability to use GPRS in the event of an internet failure.

Callpoints

The MCP range of call-points includes both indoor and outdoor models. Call points can be flush or surface mounted as a selection of back boxes and bezels are available. Anti-tamper devices are also available which fit around the unit making it less likely for persons to attempt malicious activations. The call point activation window can be a non-fragmenting element which breaks cleanly with no glass fragmentation, but needs replacing after use; or a deformable element which can be reset with a key and does not need replacing. All models have an integral alarm led. In addition to that, the range includes manual DIN call points for inside and outside use with integrated short circuit isolator.

Ancillaries

MZX Ancillary modules are an essential part of the addressable systems portfolio. These devices can monitor, control and interface equipment which is connected to but is not necessarily an integral part of the addressable system. Several contain an integral short circuit isolator which saves on additional and external isolators being fitted. Some units are powered from the addressable loop and require no external power, saving not only the power supply and battery but also the provision of a mains supply.

There are many modules providing multiple actions from a single device, saving time and the cost of installing many more single function units. Included in the range are devices to connect Gas Detectors, third party plant, including mains powered, dampers and fire doors, third party detection devices and mimic diagrams. Modules can be individually mounted, grouped in a single housing and onto din rail or inside third party equipment.

Software and Programming Tools

MZX addressable fire detection systems benefit from a suite of advanced software packages that simplify and speed up system design, installation, commissioning and service operations.

MZX Consys is a powerful programming tool designed especially for MZX Technology systems. It allows the commissioning engineer to fully customise the MZX fire detection systems operation to meet the customers specific requirements whilst ensuring that EN54 functionality is maintained. MXDesigner is a system design tool that provides a graphical user interface to simplify the detailed design of MZX Technology systems MXFlow is a graphical engineering tool designed for displaying MZX database information in a Flow Chart format.

MZX Datalogger is a PC based service tool that enables device point values to be collected from MZX panels at regular intervals for in depth analysis.

MZXRemote is a software tool which allows an MZX panel to be interrogated and controlled from a remote location.

MZX Checker is a software commissioning tool that provides a graphical way of testing and debugging cause and effect programming.

Spare Parts

The life of the fire detection system may be an issue depending upon the age of the technology when the system is purchased. Some would be weary of new technology that has not had much previous history. Others may be concerned that older technology might be phased out in a year or two and replaced by a new version. With MZX technology there is no need for concern as spare parts are constantly available and in most cases even new technology devices can be installed into older systems without any reduction in functionality. This ensures the longest possible lifespan for a fire detection system and provides an extremely low cost of ownership when compared to some systems.

1.04

Addressable Panels

PROFILE Flexible Digital Addressable Panels



ZETTLER PROFILE Flexible is a powerful fire detection and alarm system that uses MZX Technology at its heart. The system is highly resilient to external factors such as electrical noise or sources of false alarm. The touchscreen user interface with context sensitive help has been ergonomically engineered so that every operation is made easy.

Features such as the touch sensitive LEDs that provide detailed status information ensure a fast response to all system events. The system combines ease of use with high performance, and through innovation brings lifetime cost benefits to end users. The optional, sleek and discreet stand alone touchscreen user interface makes the system suitable for the most critical and sensitive environments.

The screen of the PROFILE Flexible panel display is well-structured and has an easy-to-read appearance. In addition the home screen can be customised to adopt the end user's corporate identity.

The PROFILE Flexible panel provides an extensive 10,000 event log which can be selectively viewed or downloaded and then printed or analysed using dynamic filters. These effective event diagnostics help to quickly resolve site investigations.

The Info-Button provides context sensitive help and on-screen operator instructions. This guarantees fast and reliable assistance even for infrequent users.

Screen site maps allow easy access to any information such as floors or detectors. These can be site configured so will always carry the most up-to-date information. Having all this information saves time in the event of a fire and helps to speed up responses during fire fighting. Features such as the touch sensitive LEDs that provide detailed status information ensure a fast response to all system events. The system combines ease of use with high performance, and through innovation brings lifetime cost benefits to end users. The optional, sleek and discreet stand alone touchscreen user interface makes the system suitable for the most critical and sensitive environments.

Features





- 8.4" TFT colour touch screen multilingual user interface - Architecturally attractive and fully programmable
- Ergonomic icon display - simple to operate user interface eliminates operator errors
- Touch sensitive status LED's provide event summary data - Instant access to detailed event information
- Context sensitive help and on screen operator instructions - reduces the need for user training and provides support for infrequent users
- User configurable on screen site maps - no need for additional site plans
- Programmable graphic quiescent display - opportunity for customer branding
- Comprehensive point management and disable functions - gives the user full control and reduces service and maintenance effort
- Selectively view or print from the extensive 10,000 event log using dynamic filters – effective event diagnostics to quickly resolve site investigations
- Keyless log-on using RFID tags - identifies and logs user actions
- Black-Box versions with a minimum display provide economical network solutions
- Selective loop configurations and loop power options – allows economical and flexible system designs
- Optional cloud based communications using GPRS and TCP/IP – global secure management of the system
- Easy-mount frame permits one person installation – standard on modular housings
- Slot card arrangement for expansion for easier installation and service

All necessary information can be viewed in a clear and structured way. In the case of a system event, it helps to make the right decision quickly and efficiently.

Log in options include, password, key or RFID. An RFID card will give instant user control of the menus and also log the operator access.

Practicalities such as the layout of a building or the number of alarm devices will often dictate the usable size of a detection loop and can result in unused capacity. In order to optimise loop capacity, PROFILE Flexible offers a system design solution. Addressable loops can be connected as shared power (SP) loops or combined as high power (HP) loops. The system designer can allocate all available power and 250 addresses to a single HP loop, or share resources across two SP loops. This level of optimisation can significantly reduce total installed system cost.

Panels

	Description	Order Codes
	<p>Pro215S PROFILE Flexible panel 2 shared power loops or 1 high power loop with maximum 250 addresses. TFT touchscreen display with 16 zonal LEDs. Compact housing 5 A PSU for 17 AH batteries. Networkable.</p>	557.200.841
	<p>Pro215D PROFILE Flexible panel 2 shared power loops or 1 high power loop with maximum 250 addresses. TFT touchscreen display with 16 zonal LEDs. Designer housing 5 A PSU for 38AH batteries. Networkable.</p>	557.200.842
	<p>Pro885D PROFILE Flexible panel 4 shared power loops or 2 high power loops expandable to 8 shared power or 4 high power loops with maximum 1000 addresses. TFT touchscreen display with 80 zonal LEDs. Designer housing 5 A PSU for 38 AH batteries. Networkable.</p>	557.200.846
	<p>Pro815D PROFILE Flexible panel 4 shared power loops or 2 high power loops expandable to 8 shared power or 4 high power loops with maximum 1000 addresses. TFT touchscreen display with 16 zonal LEDs. Designer housing 5 A PSU for 38 AH batteries. Networkable.</p>	557.200.845

1.06

Addressable Panels

Modular Housing Panels

	Description	Order Codes
	Pro16xD PROFILE Flexible panel 4 SP Loops or 2 HP loops. Expandable to 16 SP loops or 8 HP loops with max 2000 addresses modular housing. Note: Zonal display sold separately.	557.200.847
	Pro32xD PROFILE Flexible panel 4 SP loops or 2 HP loop. Expandable to 32 SP loops or 16 HP loops max 4000 addresses. Modular Housing. PxD Extension box for Pro32xD PROFILE Flexible panel to enable a maximum number of 32 SP loops, 4000 addresses modular housing.	557.200.848 557.200.849
	Pro16xBB PROFILE Flexible Black Box panel 4 SP loops or 2 HP loops. Expandable to 16 SP loops or 8 HP loops max 2000 addresses. Modular housing. Pro32xBB PROFILE Flexible Black Box panel 4 SP loops or 2 HP loop. Expandable to 32 SP loops or 16 HP loops max 4000 addresses. Modular Housing.	557.200.850 557.200.851
	PBB801 PROFILE battery box with 5A PSU plain door and mounting frame	557.202.854
	PXB800 PROFILE ancillary expansion box plain door and mounting frame	557.202.853
	PX-AN PROFILE aperture housing for PZ4x or PZ8x zonal display	557.202.863
	PX-PR PROFILE expansion box complete with printer	557.202.864
	P-ANC-E PROFILE Ancillary Housing with two Apertures Dimensions (H x W x D): 480 x 410 x 140 mm	557.200.844
	PZ4x PROFILE 40 way zonal display for use with PROFILE Flexible panels Pro16xD and Pro32xD.	557.202.857
	PZ8x PROFILE 80 way zonal display for use with PROFILE Flexible panels Pro16xD and Pro32xD.	557.202.858







Repeaters

	Description	Order Codes
	PR8AS PROFILE repeater panel with 80 zonal leds and AC power supply shallow housing.	557.200.560
	PR1DS PROFILE repeater compact TFT display 16 zone DC powered with shallow backbox.	557.200.801
	PR1D2 PROFILE PR1D2 2 Wire DC Display Repeater	557.200.802
	RDS800 PROFILE repeater distribution switch	557.202.812
	IMC-V111ET-TB Industrial VDSL extended media converter with 1x100Base-TX to 1xEthernet extender, Terminal block socket	557.202.901
	IMC-111FB-MM-SC Mini Type 1x 10/100TX (RJ-45) to 1x 100FX (MM SC) with Link Fault Passthrough Media Converter	557.202.902
	IMC-111FB-SS-SC Mini Type 1x 10/100TX (RJ-45) to 1x 100FX (SM SC) with Link Fault Passthrough Media Converter	557.202.903
	4510S 4510S Isolated RS485 Repeater	557.202.870

1.08

Addressable Panels

Accessories

	Description	Order Codes
	PZ4DS PROFILE 40 way zonal display shallow. Used on Pro215S, Pro215D and Pro885D	557.200.806
	PZ8DS PROFILE 80 way zonal display shallow. Used on Pro215S, Pro215D and Pro885D	557.200.811
	P-WDP PROFILE repeater back box deep	557.202.802
	P-WSH PROFILE repeater backbox shallow spare	557.202.801
	PRO-RCK PRO-RCK 19" Rack Mount Kit for use with Pro16xD and Pro32xD	557.202.868
	PRO-RCK Cable PRO-RCK Power and data cables	557.202.869
	Replacement Bezel Replacement bezel for PROFILE user interface	557.202.818

Ancillaries

557.202.841	PFI800 PROFILE Field Interface Board 4 Shared Power or 2 High Power Loops	557.200.531.P	38AH Addressable expansion PSU - matches P115D housing
557.202.842	PLX800 Loop Expansion Slot Card 4 Shared Power or 2 High Power loops	557.202.818	Replacement bezel for PROFILE user interface
557.202.844	PNI800 PROFILE Network Interface slot card	557.202.819	PROFILE zonal display inserts. Set contains zonal inserts 1-80, 81-160, 161-240, 1-40, 41-80. 81-120 and 3 x blank inserts.
557.202.848	PCH800 PROFILE PSU interface and battery charger slot card	557.202.820	PROFILE RFID Card Pack of 5
557.202.850	PSC800 PROFILE Backplane assembly with 6 slots for use with PxD a or as a spare part for Pro32xD/PxD or Pro32xBB	557.202.880	PROFILE language inserts Polish (Pack of ten)
557.202.859	POS800 PROFILE fibre optic switch single mode	557.202.881	PROFILE language inserts Czech (Pack of ten)
557.202.862	POS800 PROFILE fibre optic switch multi mode	557.202.882	PROFILE language inserts Italian (Pack of ten)
557.202.860	PCS800 PROFILE Ethernet switch	557.202.883	PROFILE language inserts Spanish (Pack of ten)
557.202.866	PROFILE PFI to TUD DCDC converter	557.202.884	PROFILE language inserts Russian (Pack of ten)
557.202.821	Flush Bezel for P1 & P4 Panels	557.202.885	PROFILE language inserts Swedish (Pack of ten)
577.202.867	PLX800 Loop card label set	557.202.886	PROFILE language inserts Danish (Pack of ten)
557.202.804	P-RCK PROFILE repeater 19 inch rack mount	557.202.887	PROFILE language inserts French (Pack of ten)
557.202.813	PROFILE P-ANC-S shallow ancillary housing	557.202.888	PROFILE language inserts Austrian (Pack of ten)
557.202.814	PROFILE P-ANC-D deep ancillary housing	557.202.889	PROFILE language inserts Turkish (Pack of ten)
557.200.530.P	PROFILE 17AH expansion power supply	557.202.890	PROFILE language inserts Swiss (Pack of four pieces, two per language French-CH and Italian-CH)

1.10

Addressable Panels

PROFILE Flexible Panel	Pro215S	Pro215D	Pro885D	Pro815D	Pro16xD	Pro16xBB	Pro32xD	Pro32xBB	PxD
General									
Number of loops	2	2	4 to 8	4 to 8	4 to 16		4 to 32 (with PxD)		
Max addresses per loop	250								
Total number of addresses	250	250	1000	1000	2000		4000		
No of zonal LEDs	16	16	80	0	Optional up to 240				
No of Zones supported	240								
Mechanical									
Dimensions HxWxD mm	480 x 410 x 140	480 x 410 x 205			580 x 458 x 209				
Weight Kg	9.7	12.5	12.5	13.0	14.0	13.5	21.0	20.5	13.0
Environmental									
Operating Temperature	-5°C to +40°C								
Storage Temperature	-20°C to +70°C								
Relative Humidity	Relative Humidity: 90% RH continuous (non-condensing)								
EMC/RFI:	EN50130-4, EN50081-1								
Electrical									
Supply Voltage (panel):	230 VAC 50/60 Hz								
Max battery capacity	17 A/H	38 A/H				Requires PBB801			

PROFILE Repeater	PR8AS	PR1DS	PZ4DS	PZ8DS
General	AC Repeater	Compact DC Repeater	Zonal Display	Zonal Display
No of zonal LEDs	80	16	40	80
No of Zones supported	240	240	120 (3 x PZ4DS)	240 (3 x PZ8DS)
Mechanical				
Dimensions HxWxD mm	480 x 410 x 205	195 x 248 x 33	195 x 248 x 33	195 x 248 x 33
Weight Kg	9.3	0.8	0.7	0.7
Environmental				
Operating Temperature	-8°C to +55°C			
Storage Temperature	-20°C to +70°C			
Relative Humidity	Relative Humidity: 90% RH continuous (non-condensing)			
EMC/RFI	EN50130-4, EN50081-1			
Electrical				
Supply Voltage (panel)	230 VAC 50/60 Hz	24 Vdc	N/A	
Input Current	0.9 A	0.2 A		
Max battery capacity	17 A/H	N/A		

Minerva T2000 and T2000 CV Marine Detection Panels IEC 61508 Approved (SIL2)



The T2000 is a fully Marine approved EN54 compliant 1 to 8 loop networkable detection panel. The T2000 supports two MZX DIGITAL detection loops and can be expanded to eight loops supporting up to 1000 addressable devices. The T2000 consists of a strong stainless steel or mild steel Marine approved enclosure incorporating the above features.

The T2000CV is a 3 loop marine approved panel housed in a mild steel enclosure designed for use in commercial vessels.

All panels have a strong cast aluminium front door, which incorporates a modular user interface that fully complies with EN54 pt2. The user interface incorporates the ODM800 operator display module with a 16 x 40-character backlit LCD display, simple alphanumeric keypad and 5 softkeys.

The OCM800 operator control module provides all mandatory operator control keys and LED functions including Day/Night switching. One control key and 2 indication LEDs are provided for vessel specific functions. Control keys and LEDs are labelled in English according to the default Marine functionality. The slide in decals can be reversed and alternative text added.

The batteries and any additional zonal LED's or operator controls are mounted in a separate housing which can be mounted below the main panel or behind the panel. The battery box incorporates a heavy duty backbox and battery clamp.

The chassis plate in the battery box also has space for up to 2 x IOB800 input/output expansion modules (maximum 24 I/O) or 1 x PSU830.

Features

- PSU830 5 A 24 V DC battery backed power supply and loop booster to EN54pt4
- FIM800 field interface PCB incorporating one or two MZX DIGITAL loops
- CPU801 32 bit processor and memory card
- Optional network card and additional loop card(s) (T2000 only)
- VDR (Voyage Data Recorder) Interface as standard

Order Codes

557.200.600	T2000 Two To Eight Loop Marine Panel (Stainless steel enclosure)
557.200.602	T2000B Battery Box (Stainless steel enclosure)
557.200.605	T2000 BM Battery Box (Mild steel enclosure)
557.200.606	T2000 RMRS Door Stay Kit
557.200.610	T2000 Standard Two to Eight Loop Marine Panel (Mild steel enclosure)
557.201.216	T2000 XLM 8-Loop Mounting Kit
557.200.620	T2000CV 3 loop marine panel (mild steel back box)
557.202.127	VDR Cable For a Standalone panel, Com port 3
557.202.128	VDR Cable for a networked system, Com port 1
557.180.454	Marine Bulkhead Mount
557.180.452	Marine 19" rack mount kit for use with surface mounting housings
557.201.233	PSU 830 T2000/T2000R Conversion Kit
557.201.234	PSU 830 T2000 120 VAC Kit
508.023.126	AC2SW 230 VAC Changeover Unit
508.023.127	AC1SW 115 VAC Changeover Unit

1.12

Addressable Panel Ancillaries

Minerva T2000R and T2000R CV Marine Repeaters IEC 61508 Approved (SIL2)



The T2000R full function repeater is an EN54 Marine approved repeater with optional addressable EN54:Pt.4 power supply. The repeater consists of a steel backbox and cast aluminium front door which incorporates the ODM800 operator display module with a 16 x 40 character backlit LCD display, simple alphanumeric keypad and 5 softkeys. The OCM800 operator control module provides all mandatory operator control keys and LED functions including Day/Night switching. One control key and 2 indication LEDs are provided for vessel-specific functions. Control keys and LEDs are labelled in English according to the default Marine functionality. The slide in decals can be reversed and alternative text added. The back box has a removable chassis plate with the PSU830 power supply and space for 2 x 7 Ah batteries to provide 72h backup.

The T2000R CV indicating repeater is an EN54 Marine approved repeater (24Vdc Supply). The repeater consists of a mild steel backbox and cast aluminium front door which incorporates the ODM800 operator display module with a 16 x 40-character backlit LCD display, simple alphanumeric keypad and 5 softkeys. Operator controls comprise a panel buzzer silence button, status LED's are provided for fire, fault and power on indication.

Both repeaters are connected to the Panel via the remote bus (RS485, 1200 m distance). A maximum of 7 repeaters (including one MZX REMOTE repeater) can be linked to each control panel and can provide repeater functions for all panels on the system.

The repeater can support up to 80 inputs and outputs in the form of LED annunciators, IOB800 input/output modules, XIOM universal I/O modules or the 80 LED mimic module.

Features

- Fully Functional
- Optional Approved Mild Steel Enclosure
- Fully Monitored R-Bus

Order Codes

557.200.601	T2000R Marine Repeater with Power Supply Unit 240 VAC (Stainless steel enclosure)
557.200.604	T2000R Marine Repeater without Power Supply Unit 24 VDC (Stainless steel enclosure)
557.200.606	T2000 RMRS Door Stay Kit
557.200.611	T2000R Standard Marine Repeater with Power Supply Unit 240 VAC (Mild steel enclosure)
557.200.612	T2000R Standard Marine Repeater without Power Supply Unit 24 VDC (Mild steel enclosure)
557.200.621	T2000R CV Marine Indicating Repeater without Power supply unit 24 VDC (Mild Steel enclosure)
557.201.233	PSU 830 T2000/T2000R Conversion Kit
557.201.234	PSU 830 T2000 120 VAC Kit
508.023.126	AC2SW 230 VAC Changeover Unit
508.023.127	AC1SW 115 VAC Changeover Unit

XLM800 MZX Loop Expansion Module

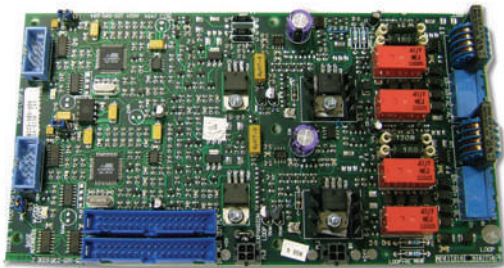

The XLM800 Loop Expansion Module fits “piggyback” style onto the FIM or an existing XLM800 and is used to:

- 640 Character display
- Displays first alarm and most recent alarm

The XLM800 Loop Expansion Module controls the communications between the detectors (and other ancillaries) connected on the 2-wire loop circuits and the controller. In addition, the addressable interface contains line isolation circuits which protect the loop driver circuit from short-circuit conditions.

Technical Information

Dimensions: 17.5H x 104W x 196D mm
Battery Requirements: Standby 104.3mA + loop current
Alarm 105.3mA + loop current
Loop Current 495 mA maximum

Order Code

557.202.007 XLM-MX Two Loop MZX Digital Expansion Card

1.14

Addressable Panel Ancillaries

FIM800 Field Interface Module



The Field Interface Module FIM is the main interface for field wiring on MZX detection panels and contains plug-in field wiring terminals, inter board connectors, EMC protectors and filters and general I/O electronics.

The FIM801 and FIM801CV provides 1 x MZX DIGITAL loop and the FIM802 provides 2 x MZX DIGITAL loops. Each MZX DIGITAL loop can support several kilometres of loop wiring using a mixed topology using multiple loops and spurs.

The FIM provides up to 495 mA of loop power to each loop to drive loop powered sounders and other loop power devices. An optional plug-in additional loop cards (XLM800-MX) provide up to 8 x MZX Digital loops.

The FIM incorporates the following local I/O connections:

- 2 x reverse polarity monitored sounder outputs
- 2 x volt free outputs (Default alarm and fault)
- 1 monitored input (eg. Day/Night changeover)
- 1 emergency alarm input
- 1 unmonitored input (eg. Class Change or Tamper)
- Full monitoring of power supply
- Ground fault monitoring

The FIM incorporates a local I/O bus which allows the local I/O connections to be increased by 24. A variety of I/O expansion boards are available including:

- IOB800 (8 in/8 out) expansion board

The FIM includes two connections to the RBUS one for the local user interface and one for connecting up to 15 remote addresses in the form of up to 2 x operator control modules (OCM800) or up to 15 multi-purpose modules (MPM800).

The FIM provides 3 configurable external serial ports :

- Port 1 Local printer
- Port 2 Configuration PC or remote diagnostics and upload download modem
- Port 3 FSI open protocol or Network card/gateway TLI800EN (not provided on FIM 801CV)

Technical Information

Dimensions:	25H x 105W x 196D mm
Weight:	156g
Power Consumption:	119mA (Quiescent - excluding loops and operator interface) 169mA (Alarm)
Relay Outputs:	30Vdc @ 2A
Monitored Inputs:	10k Ohm EOL, 3KHz in parallel
RBUS:	RS-485, default 19.6kB, up to 1200m
Serial Ports:	RS232C, 19.6kB, up to 10m
Local I/O Expansion:	Up to 2 modules, up to 24 I/O, max. 300mm

Order Codes

557.202.000	FIM801 field interface module with one MZX loop driver
557.202.001	FIM802 field interface module with two MZX loop drivers
557.202.008	FIM801CV for Marine T2000 CV

PSU830 Power Supply



The MZX PSU830 power supply module is a state-of-the-art integrated switch mode system power supply and battery charger, which can provide up to 5 A external and auxiliary loop power during alarm conditions.

The charging voltage is temperature compensated. The power supply recharges the batteries within 24hr for the following timings:

- 90hr stand by time and 15 minute alarm condition.
- 72hr stand by time and 30 minute alarm condition.

The power supply provides full condition and fault monitoring to the system via the FIM. The PSU830 incorporates a booster module to provide the correct voltage levels to maximise the performance of the MZX DIGITAL protocol.

Fault signals (Loss of AC, Battery charger fault, Battery fault and earth fault) are provided. Battery voltage readings are also provided to the FIM and a volt free fault o/p is also provided.

Screw terminals provide 2 x 27V outputs (one with reset control) and one 5 V output. The power supply is fitted in a steel cage with mounting points to allow any of the following boards to be mounted:

- APM800 addressable power supply monitor module.
- FB800 fuse board with 15 x 24 Vdc fused spurs.
- IOB800 input/output expansion board.
- PTM800 power terminal module.

Features

- Universal Input Voltage
- Temperature Compensated
- Full Fault Monitoring
- Can drive 4 fully loaded MZX digital loops
- Meets the requirements of EN54 part 4 amendment 2

Technical Information

Dimensions (HWD):	62 x 132 x 242 mm
Electrical	
Input Voltage:	120-240 Vac -15% /+10% 50/60Hz (auto ranging)
Input Current Rated Load:	0.8-2.2 A ^{RMS}
Output Voltages:	27.3Vdc @ +25°C
Non-reset:	27.3Vdc @ 2A 5Vdc @ 2.2A
Reset:	40Vdc @ 2.2A
Rated Output	27.3 Vdc @ 2A
Maximum Alarm Current:	
Maximum continuous load current (excluding charging):	5A for 30 minutes
Battery Requirements	
	2.5 A
	17 Ah or 38 Ah single PSU
	65 Ah dual PSU
Standby Current Consumption:	90 mA @ 24 Vdc
Battery Fault High Resistance:	Single PSU 0.6 Ohms Dual PSU 0.3 Ohms

Order Codes

557.202.210	PSU830 Power Supply Module
557.201.232	PTM800 Power Terminal Module
557.202.044	PSU 830K Power Expansion Kit
557.202.030	PSU 830 Panel Fixing Conversion Kit
557.202.031	PSU 830 Small Chassis Plate Conversion Kit

1.16

Addressable Panel Ancillaries

OCM800 Operator Control Module

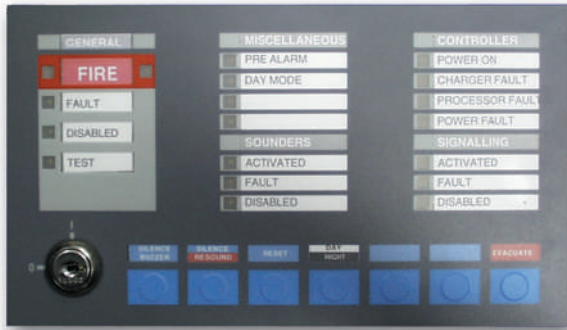

The OCM800 is utilised by all MZX detection panels and full function repeaters to provide mandatory operator control and LED indication functions to comply with EN54:pt.2. The OCM800 is fully programmable but operates in default configurations according to the software template used.

Most software templates allow several of the LED's and control buttons to be programmed for site-specific functions. The LED's and control buttons both have slide in legends to suit the default configurations and language. Standard panels include the appropriate legends for their relevant markets.

The OCM800 incorporates the functionality of an MPM800, which allows it to drive an operator display module to provide a complete panel user interface.

In addition the OCM800 can drive up to 80 inputs/outputs using one of the following modules.

The following I/O and LED annunciator modules can be slaved from an MPM800:

- Up to 5 x IOB800 (8 in/8 out LPCB/VdS approved expansion board)
- Up to 5 x XIOM (16 way universal I/O board)
- One Mimic Panel (80 way LED mimic driver PCB)
- One 80 way ANN880 LED mimic
- One 40 way ANN840 LED mimic using red & yellow LED's
- One 20 way COM820 LED status/command modules

Up to 2 x OCM800 units can be connected to an MZX panel via the internal or external RBus communication port.

Features

- Changeable Legends
- Fully programmable
- Optional I/O via R-Bus

Technical Information

Dimensions:	50H x 232W x 133D mm
Weight:	0.272 Kg
Power Consumption:	35 mA (Quiescent) 36 mA (Lamp test) 81 mA (Alarm)
Control Buttons:	7
Indication LED's:	18
Communications:	RS-485: RBus Default 9.2 Kb
Expansion Bus:	MZX X-Bus
Legends for LPCB modules:	UK/English, Marine

Order Code

557.202.013 OCM800 with Minerva MZX Inserts

ODM800 Operator Display Module

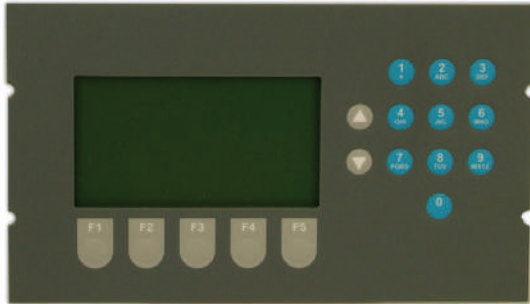

Features

- 0-9 alpha-numeric phone style keypad
- Up and down scroll keys
- Five function keys

Technical Information

Dimensions:	25H x 232W x 133D mm
Weight:	0.361 Kg
Power Consumption:	50 mA (Quiescent)
	900 mA (Alarm Backlit)
	50 mA (Alarm during mains failure)

The ODM800 operator display module provides a powerful and flexible 40 x 16 character backlit LCD display used by all MZX detection panels and full function repeaters. The ODM800 is used with the OCM800 to provide a fully compliant and approved user interface EN54 fire detection panel.

The ODM800 is powered and controlled by the OCM800 operator control module and provides various functions according to the panel software. Standard EN54 panels use the LCD display as five windows on the system.

- Window 1-Details of first detector in alarm
- Window 2-Details of the most recent detector in alarm
- Window 3-System Status including Alarm/Fault and Isolate counters
- Window 4-Full alarm/event details and lists including 95 character procedure plus full password controlled system manager, service and engineering menu structure
- Window 5-Function key legends (eg. Back, Enter, >>, <<)

Order Code

557.202.019 ODM800 operator display module

OCM800 TO IOB800 CONNECTION DETAILS

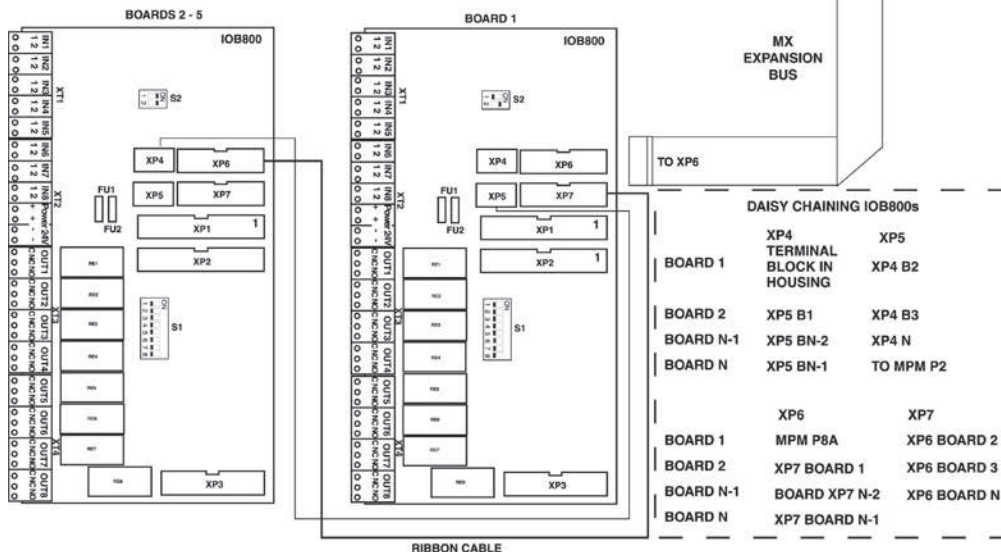

1.18

Addressable Panel Ancillaries

MPM800 Multi Purpose Interface Module

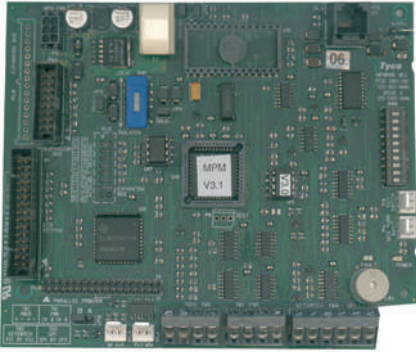

The MPM800 is used to provide various expansion capabilities via the remote bus (RBUS). The MPM800 is provided as a standalone module but is also incorporated into the circuitry of the OCM800 operator control module to drive the LCD display, LEDs, keyswitch and keys on the OCM800 and the operator display module. The OCM800 and MPM800 have an XBUS which can be used to drive up to 80 I/O. The MPM800 also has a printer interface for connecting to a serial or parallel printer.

An additional printer driver kit is required to allow the MPM800 to drive a printer - a serial isolation module should be used to eliminate earth fault indications caused by some mains connected printers.

Up to 15 x MPM modules can be connected to each panel of which 8 can be in the form of OCM800 (including the main OCM800 user interface). One OCM800 can also be in the form of an emulated user interface on a remote PC connected via the network or dial up modem.

The following I/O and LED annunciator modules can be slaved from an MPM800:

- Up to 5 x IOB800 (8 in/8 out expansion board)
- Up to 5 x XIOM800 (16 way universal I/O board)
- One Mimic Panel (80 way LED mimic driver PCB)
- One 80 way ANN880 LED mimic**
- One 40 way ANN840 LED mimic using red & yellow LEDs**
- One 20 way COM820 LED status/command modules**

The MPM800 is mounted by plugging directly onto the back of those items marked **

Features

- Drives up to 80 I/O points
- Direct Interface to Zonal Displays and other Modules
- Interfaces to FIM Board

Technical Information

Dimensions:	25.4H x 92W x 167.64D mm
Weight:	98g
Power Supply:	24Vdc (from PSU830)
Communications:	RS-485, up to 19.6kB
Printer Connection:	Serial or Parallel

Order Codes

557.202.012	MPM800 multi-purpose interface modules
557.202.117	Serial printer cable for MPM800 or FIM800
557.180.052	Serial Printer Driver Kit only required for earlier MPM800 Modules
557.180.053	Isolated RS485 IC (for U16)

ANN840 LED Annunciator



The ANN840 is a standard LED annunciator user interface module which can be driven from an OCM800 or an MPM800. The MPM800 can be mounted remotely or "piggy-backed" on the ANN840. The ANN840 has removable legends for 40 zone status indicators. Each zone can indicate RED (eg. Alarm) and YELLOW (eg. Fault & Isolate). The functionality is programmed in the MZX detection panel. The ANN840 operates as 80 outputs (RED & YELLOW).

Technical Information

Dimensions:	25H x 232W x 133D mm
Weight:	177 g
Power Consumption:	1mA + MPM800 (Quiescent) 85 mA + MPM800 (25% zones in alarm) 340 mA + MPM800 (Lamp test)

Order Code

557.202.021 ANN840 LED annunciator

ANN880 LED Annunciator



The ANN880 is a standard LED annunciator user interface module which can be driven from an OCM800 or MPM800. The MPM800 can be mounted remotely or piggy-backed on the ANN880. The ANN880 has 80 red LEDs numbered 1-80. The functionality is programmed in the MZX detection panel but is defaulted to zone alarm LED's.

Technical Information

Dimensions:	25H x 232W x 133D mm
Weight:	177g
Power Consumption:	1mA + MPM800 (Quiescent) 85 mA + MPM800 (25% zones in alarm) 340 mA + MPM800 (Lamp test)

Order Code

557.202.022 ANN880 LED annunciator

COM820 Status Command Module - 20 Way



The COM820 is a standard user interface module which can be driven from an OCM800 or MPM800. The MPM800 can be mounted remotely or piggy-backed on the COM820. The COM820 has removable legends for 20 status command functions. Each function includes a command button and a yellow status LED. The functionality is programmed in the MZX detection panel. Typical applications include:

- Manual/OFF/Auto/Isolate functions for evacuation or plant control
- Selective isolate and evacuate functions for fireman's control
- Selective plant shutdown and override functions
- Selective system delay and timer functions

Technical Information

Dimensions:	25H x 232W x 133D mm
Weight:	204g
Power Consumption:	0.267mA (Quiescent - No LED's) 5mA (Alarm - 25% LED's) 21mA (Lamp test)

Order Code

557.202.020 COM820 Status/Command Module

1.20

Addressable Panel Ancillaries

Remote Mimics



The 80-Way Mimic allows custom-made display and presentation panels to be incorporated into an MZX network. The single PCB can be mounted in an expansion box or on the rear of a free-standing panel and can be used to drive up to 80 zonal LED indicators, arranged in any configuration, together with two FIRE LEDs, one FAULT LED and one ISOLATE LED. The indicators operate in the same manner as the corresponding indicators on the panel. A remote mimic can also be connected to an MPM800 configured as a remote mimic driver. Up to 15 MPM800's can be connected on to the remote bus, each with a unique address. The Mimic includes audible and visible warning facilities.

Technical Information

Dimensions:	235H x 190W mm
Operating Temp:	-10°C to +55°C
Storage Temp:	-20°C to +65°C
Relative Humidity:	Up to 95% RH Non- Condensing
Power Consumption:	11mA (Quiescent) 200mA (25% Alarm) 800mA (Lamp Test)

Order Code

557.180.005 80 way mimic driver module

FB800 Fuse Board

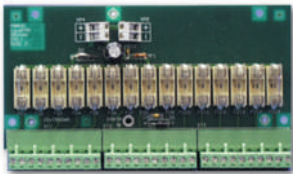

The FB800 fuse board provides terminations for 15 fused 24Vdc output spurs from a single 24V d.c. input. The FB800 is designed to be normally mounted on the PSU830 power supply. The fuses are rated at 500mA.

Technical Information

Dimensions:	93H x 165W x 80D mm
Weight:	149g
Input:	24Vdc
Output:	15 x 24V d.c / 500mA
Terminations:	2.5 mm

Order Code

557.202.100 FB800 Fuse board (15 way)

IOB Input/Output Expansion Board

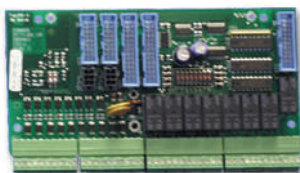

The IOB800 is an LPCB approved board providing panel I/O expansion of 8 opto-isolated digital inputs and 8 x 24V d.c. relay outputs. The IOB800 also incorporates a connector which provides decoded signals for the 8 inputs and 8 outputs for specialist interfacing.

Expansion to the following panel components is possible:

- FIM801/802 field interface modules (maximum 24 I/O 8IN/16OUT)
- OCM800 operator control modules (maximum 80 I/O)
- MPM800 multi-purpose interface (maximum 80 I/O)

Technical Information

Dimensions:	15H X 164W X 80D mm
Weight:	153g
Terminations:	1.5 mm

Order Code

557.202.006 IOB800 Expansion Board and cables

The IOB800 can be mounted in the top of a battery box or repeater. The device has two expansion bus connectors which allow them to be daisy chained together.

XIOM Input/Output Expansion Board

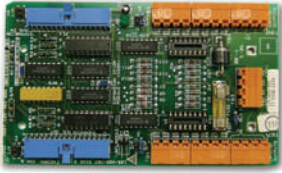

The XIOM is a 16 universal input/output expansion board. The I/O on the XIOM can be set in banks of 8 to operate as follows:

- LED driver outputs (10mA source)
- Relay Driver Outputs (100mA sink)
- Voltage Monitor Input (8 - 30Vdc Normal)
- Volt Free Contact inputs

Features

- 16 I/P's or 16 O/P's or 8 I/P + 8 O/P
- 5 per MPM800 (80 I/O points)
- Fully configurable in MZX Consys

Technical Information

Dimensions: 144H x 85W x 15D mm

Order Code

557.180.016 XIOM MINERVA Input/Output Expansion Module (16 Way)

Desktop Printer



The printer is designed as a low cost business printer ideally suited for mounting adjacent to the fire control panel. The LQ-350 combines high performance with paper handling flexibility and quiet operation.

Technical Information

Dimensions: 159H x 366W x 275D mm

Weight: 4.4kg

Operating Voltage: 180V to 264Vac

Order Code

557.180.244 Epson LQ-350 printer
 557.180.220 LQ 300+ Printer Ribbon (spare)
 557.202.117 MZX FIM/MPM to serial printer lead

PRN800 Printer Kit



The PRN800 Printer Kit is designed for use with the designer range of MZX Controllers. It is fitted to the front cover of the MZX battery housing and is powered from the PSU830 power supply via an FB800 fuseboard in the MZX Controller housing. The PRN800 supports the Western European Language Code Page 850 which includes Danish, Dutch, English, French, German, Italian, Norwegian, Portuguese, Spanish and Swedish.

Key Features:

- Thermal printer mechanism ensures high reliability
- Quiet Operation
- Lightweight and Compact Design
- High Speed Printing: 40 mm per second.
- High quality printing: 384 dots.

Technical Information

Dimensions: 230H x 137W x 85D mm

Weight: 0.38Kg

Operating Temp: +5°C to +45°C

Storage Temp: -20°C to +70°C

Relative Humidity: Up to 80% non-condensing

EMC: 61000-6-3 for emissions

BS EN 50082-1 for immunity

Order Code

557.202.024 PRN 800 Printer c/w front cover module
 557.301.014 Spare Paper Roll (pk of 5)

1.22

Addressable Panel Ancillaries

DDA Compliant Pager - Fire Tek Pro Paging System



The FireTek Pro paging system is designed for use with Fire Systems installed in commercial, industrial and educational premises. The system is designed to alert the "hearing impaired" in the event of a fire or other emergency where an audible sounder is the normal means of indication. The FireTek Pro has been designed to comply with BS5839-1: 2002 in regard to alerting the "hearing impaired" to the activation of a fire alarm. The system can be used in conjunction with a security panel to alert guards who may be located remotely.

The interface to the fire panel comprises of three Prioritised Fire Inputs and two Fault Inputs. A monitored cable assembly is provided with each system which includes a "common fault" relay output back to the host fire panel. This output will activate if the FireTek Pro suffers a mains failure, transmitter fault, antenna mismatch, interface link failure, or low battery state.

Upon activation of any one of the Fire Inputs, the unit will enter the fire alert condition, prioritising and transmitting the Fire message to all enrolled pagers. The transmissions will be repeated until the fire condition is reset. The pagers ensure that users are alerted by distinct vibration patterns and clear text messages.

UHF Radio Operation

The unit utilises UHF radio frequencies, the main benefits being superior in-building radio signal propagation and the option of a manual frequency co-ordinate license issued by OFCOM. Licensing the FireTek Pro provides a higher degree of protection from interference. This fact is acknowledged in Section 18.1 of BS 5839-1:2002.

High Integrity Pagers

The pagers have added features specifically incorporated for the hard of hearing when used with the FireTek Pro. These include distinct vibrate alerts for emergency messages, a vibrating out of range indicator which displays a "No Service" message when the radio link is lost, and a vibrating low battery indicator.

Antenna Options

Mini Dipole - remote internally mounted antenna

Folded Dipole - remote externally mounted antenna

Features

- UHF radio link for maximum licensable protection
- Unique coding avoids neighbouring system clashes
- Self monitoring of system health
- Rugged steel enclosure to IP65
- Backlit 2 line text display continuously reports system status
- Additional audible & visible status indicators
- Prioritised Fire Alarm Inputs
- Automated test calls alert pagers to loss of radio signal
- Fault Notification to the lost fire panel via a monitored link
- Key operated "System Test" facility for routine confidence checking
- Over 90 hour's backup operation with internal battery
- Achieves Disability Discrimination Act (DDA) compliance

Technical Information

Supply Voltage:	230 V AC 50-60 Hz 12 v 7Ah standby battery
Operational Current:	250 mA
Inputs:	3 Prioritised Volt Free (Fire) Input 1 - Fire Alarm - Evacuate Building Input 2 - There is an Incident - Leave Building Input 3 - Prepare to Evacuate - Await Instructions 2 Volt Free (Fault)
Outputs:	1 off volt free relay output
Fault Notification:	Mains Failure Transmitter Fault Antenna Mismatch Panel Link Failure Low/Missing Battery
Visual Display:	2 Line Backlit LCD
Enclosure:	Steel Enclosure rated to IP65
Dimensions:	380 x 320 x 110 mm (HxWxD) (No antenna fitted)

Order Codes

557.200.071	Paging Transmitter
557.200.074	40 Character Alpha Numeric Pager
557.200.076	1/2 wave dipole antenna
557.200.077	Wall mounting folded dipole antenna
557.200.078	Pole mounting folded dipole antenna
557.200.079	5 metre antenna feeder cable
557.200.080	10 metre antenna feeder cable

Pager Interface



The MZX pager system is designed to provide a facility to signal all text messages or alarm/fault messages from a local transmitter to the pagers.

The transmitter connects to the serial printer port on the FIM800 or if already in use to a MPM800. The pager system requires a +12 V d.c. connection from a remote psu. If the transmitter needs to be located further than 2 m from the MZX Panel, then a non-standard serial printer cable may be used, up to a maximum distance of 14 m.

The Type A alarm pager displays alarm and critical fault messages, (ie power supply failure or mains failure). The Type A maintenance pager displays all messages sent by the fire controller.

CAUTION: Before any installation is carried out, an on site radio paging license must be obtained by the customer. Care should be taken when designing pager systems. Normal practice indicates that a site survey should be done. Contact Product Management for additional advice on site surveys.

Features

Pagers:

- Display messages sent out by the MZX as displayed on the MZX LCD
- Internal log of up to 40 events
- Audible and/or vibrate warning of event
- Allows the event log to be displayed

Transmitter:

- Connects using a 9 way D type MZX interface lead to MZX printer port

Technical Information

System operating voltage:	12 to 13.8 Vdc
Effective radiated power:	500 mW Max
Frequency range:	450-470 MHZ
Channel spacing:	25 KHz
TX baud rate:	512 or 1200
Type approval:	ETS 300 224, EC type approved to ETS 300 682

Manual - Vol17A-2-Pager

Order Codes

557.200.029	Pager Transmitter
577.002.002	Type A alarm pager
577.002.003	Type A maintenance pager
577.002.007	Pager aerial 60 db gain up to 1km (c/w mounting bracket)
577.002.008	Optional feeder cable (10m long)
G13801N-A	Elmdene 12 V 1 A PSU in Housing

1.24

Addressable Detectors

850 and 830 Series Fire Detectors - Generation 6 IEC 61508 Approved (SIL2)



The 850 and 830 series of fire detectors are designed to be both adaptable and flexible which means they can be used in most premises to protect against a wide range of potential fire risks. They use sophisticated digital signalling to communicate with the MZX Technology fire control panel, sending fire data from each sensing element for analysis. Because all of the sensed data is sent to the controller, powerful algorithms can be used to determine whether a fire condition is real or not. The sensitivity, mode and degree of verification can be altered by the user in response to environmental or activity changes.

A built-in line isolator incorporated into the 850 series devices means that when a single short circuit fault occurs on a loop, all the detectors will continue to operate. An on-board amber LED will give a local indication that the line isolator has operated. The 830 series detectors can be used with an isolator base to provide protection against short circuit faults.

Two way infrared communications allows the detector to work with the 850EMT Engineering Management Tool to speed up commissioning and service routines and to provide status / reports data without the need to physically access the device. Extended drift compensation reduces the lifetime cost of ownership by typically doubling the service life of the detector whilst a new insect screen and surface coating of electronics results in a robust industrial design. Both 850 series and 830 series detectors are environmentally friendly. They do not use any radioactive parts and can be returned for recycling at the end of their life.

Features

- Advanced multi-sensor designs
- Choice of heat, optical, optical and heat multi-sensor or 3oTec triple multi-sensor
- FASTLOGIC expert algorithms
- Up to 250 detectors per loop
- Built-in line isolator on 850 series
- Advanced commissioning features using the 850EMT Engineering Management Tool
- Two way infra-red communication to the 850EMT Engineering Management Tool
- Protective optical chamber screen
- Robust coated electronics
- Extended service life
- Fire, isolate and fault LED indications
- Green Passport Certified

The detectors are constructed from hard wearing flame retardant FR3010 'BAYBLEND' plastic. They are supplied with dust covers as part of the packaging which essentially prevents contamination entering the detection chambers during installation, after which they are removed.

850PH, 851PH and 830PH Photo Heat Multi-Sensor Detectors



With its ability to detect a wide range of fires from flaming to smouldering types, the combined optical and heat multi-sensor detector is the preferred choice for a range of applications including light industrial, retail and office environments.

It operates in a number of approved modes and sensitivities that can be dynamically selected to suit different environmental conditions.

Technical Information

Detector material:	Flame Retardant FR3010 'BAYBLEND'
Dimensions:	Height 43mm / Dia.109mm
Colour:	White
Weight:	76g (Excluding Base)
Voltage:	20–40 VDC
Quiescent Current:	380µA
Alarm Current:	3.3mA
Operating Temp:	-25°C to +70°C
Storage Temp:	-40°C to +80°C
Relative Humidity:	95% (non-condensing)
Approvals:	EN54-5 and EN54-7, CPD, VdS
Type Approval:	CEA4021 851PH MED Approved

Order Codes

516.850.051	850PH Photo Heat Detector with built in line isolator
516.830.051	830PH Photo Heat Detector
516.850.055	851PH Photo-Heat Detector with built in line isolator Marine

850P and 830P Photo Detectors



More benign environments where any potential fire will be slow burning can be protected using the optical detector. A choice of sensitivities and modes gives this detector a broad range of applications.

Technical Information

Detector material:	Flame Retardant FR3010 'BAYBLEND'
Dimensions:	Height 43mm / Dia.109mm
Colour:	White
Weight:	76g (Excluding Base)
Voltage:	20–40 VDC
Quiescent Current:	380µA
Alarm Current:	3.3mA
Operating Temp:	-25°C to +70°C
Storage Temp:	-40°C to +80°C
Relative Humidity:	95% (non-condensing)
Approvals:	EN54-7, CPD, VdS
Type Approval:	CEA4021 851PH MED Approved

Order Codes

516.850.052	850P Photo Detector with built in line isolator
516.830.052	830P Photo Detector

1.26

Addressable Detectors

850H and 830H Heat Detectors



Complimenting the range is the heat sensor which can operate in fixed temperature and rate-of-rise modes with a number of approved sensitivities. It is most often used in areas where high levels of dust are present or where the environment precludes the use of smoke detectors.

Technical Information

Detector material:	Flame Retardant FR3010 'BAYBLEND'
Dimensions:	Height 43mm / Dia.109mm
Colour:	White
Weight:	81g (Excluding Base)
Voltage:	20–40 VDC
Quiescent Current:	335µA
Alarm Current:	3.3mA
Operating Temp:	-25°C to +70°C
Storage Temp:	-40°C to +80°C
Relative Humidity:	95% (non-condensing)
Approvals:	EN54-5, CPD, VdS
Type Approval:	MED Approved

Order Codes

516.850.053	850H Heat Detector with built in line isolator
516.830.053	830H Heat Detector

850PC and 830PC 3oTec Triple Sensor Detectors



For life protection and when the environmental conditions are challenging, the 850PC/830PC 3oTec detector provides the ultimate in detector performance and false alarm rejection. It is a multi sensor that uses optical, heat and carbon monoxide sensors in concert to accurately determine the presence of fire.

Applications include industrial, retail, transport hubs, and healthcare. Its false alarm rejection properties make it the ideal choice for hotel bedrooms where steam from bathrooms is a common source of false alarms.

Technical Information

Detector material:	Flame Retardant FR3010 'BAYBLEND'
Dimensions:	Height 43mm / Dia.109mm
Colour:	White
Weight:	94g (Excluding Base)
Voltage:	20–40 VDC
Quiescent Current:	420µA
Alarm Current:	3.3mA
Operating Temp:	-10°C to +55°C
Storage Temp:	-20°C to +55°C
Relative Humidity:	95% (non-condensing)
Approvals:	EN54-5 and EN54-7, CPD, VdS
Type Approval:	VdS2806, CEA4021 MED Approved

Order Codes

516.850.054	850PC 3oTec Triple Sensor Detector with built in line isolator
516.830.054	830PC 3oTec Triple Sensor Detector

800F Flame Detectors



The 800F is a digital addressable, low cost infrared flame detector with some high end features such as 'Solar Blind' operation for false alarm free reliability and an automatic health check feature. They will detect a 0.1m² flaming fire at a range of 20m. Uses the standard MZX detector bases and MZX base accessories. An Intrinsically safe version is available as part of the System 800 I.S. range.

Technical Information

Dimensions:	Height 21.2mm / Dia. 109mm
Weight:	74g (Excluding Base)
Operating Temp:	-20°C to +70°C
Storage Temp:	-40°C to +80°C
Relative Humidity:	90% RH Continuous (non-condensing)
Range:	0.1m ² n-heptane at 50m
Field of View:	100°
Approvals:	EN54 pt10 Certification

Order Codes

516.800.006	801F LPCB
516.800.007	811F Marine

800 Series MZX Address Flag

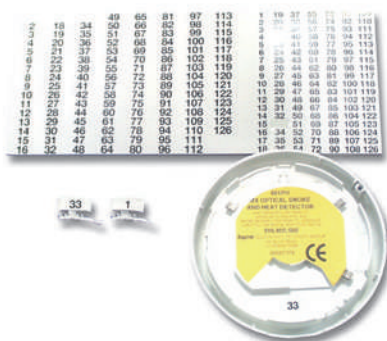

Order Codes

516.800.915	MZX Address flags (pack of 100)
516.800.931	Address flag labels Loop A - White
516.800.932	Address flag labels Loop B - Yellow
516.800.933	Address flag labels Loop C - Purple
516.800.934	Address flag labels Loop D - Green
516.800.935	Address flag labels Loop E - Grey
516.800.936	Address flag labels Loop F - Blue
516.800.937	Address flag labels Loop G - Orange
516.800.938	Address flag labels Loop H - Red

The 800 Series detectors incorporate a feature, which automatically transfers the address flag to the detector base, when the detector is plugged into the base. On removal of the detector the address flag remains on the ceiling, thus ensuring that detectors are not accidentally returned to the wrong detector base following service routines.

Most MZX detection panels incorporate additional fail safe software features to ensure that incorrect detector positioning does not compromise the system. Address flags are supplied in packs of 100. Labels are provided on sheets of 250 in eight colours to enable quick identification between different loops.

1.28

Addressable Detector Bases

Standard Detector Bases 4B-C 4" Continuity Base

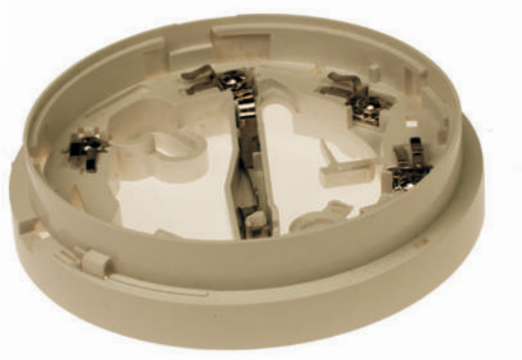

The new 4B-C 4" continuity base is designed to snap-fit to the ceiling tile adaptor or it can screw fix to a ceiling in the traditional manner. The 4B-C 4" continuity base is designed specifically for use with the 850 series detector and provides a switching mechanism that ensures continuity when the detector (and built-in short circuit isolator) is removed. When used with the time saver ceiling tile adaptor, the 4B-C 4" continuity base uses a snap-fit mechanism that saves installation time.

Features

- For use with the 850 series detectors
- Compact rigid design that improves the appearance and is easy to install
- Built-in continuity switch that closes on detector removal
- Electronics free, permits in circuit testing
- Snap fit to the time saver ceiling tile adaptor
- Detector locking pin included
- Detector park position for service and commissioning, holds the detector mechanically in place whilst disconnected from the loop and continuity switch is closed
- Choice of 8 mini-trunking break-outs

Order Code

517.050.042 4B-C 4" Continuity Base

4B 4" Detector Base



The new 4B 4" detector base is designed to snap-fit to the ceiling tile adaptor or it can be screw fixed to a ceiling in the traditional manner.

Features

- Compatible with 830 series detectors
- Drives a remote indicator
- Detector locking pin provided with every base
- Snap fits to the Time Saver Ceiling Tile Adaptor
- Fits directly to a British or European electrical back box
- Temporary park position
- Break-outs for surface mount

Order Code

517.050.041 4B 4" Detector Base

4B-I 4" Isolator Base

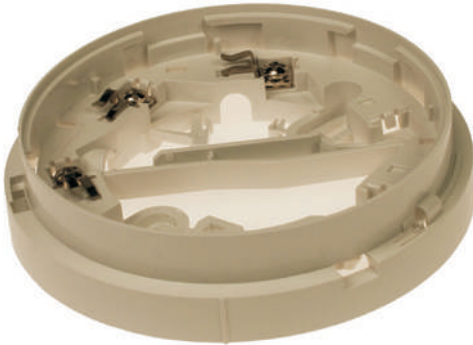

The new 4B-I 4" Isolator base is designed to snap-fit to the ceiling tile adaptor or it can screw fix to a ceiling in the traditional manner. The 4B-I 4" base is designed specifically for use with the 830 series detectors and provides protection against short circuit faults on the MZX digital addressable loop.

Features

- For use with the 830 series detectors
- Compact rigid design that improves the appearance and is easy to install
- Up to 250 x 4B-I 4" isolators can be connected on each loop
- Snap fit to the time saver ceiling tile adaptor
- Detector locking pin included
- Detector park position for service and commissioning, holds the detector mechanically in place whilst disconnected from the loop
- Choice of 8 mini-trunking break-outs

Order Code

517.050.043 4B-I 4" Isolator Base

Ceiling Tile Adapter

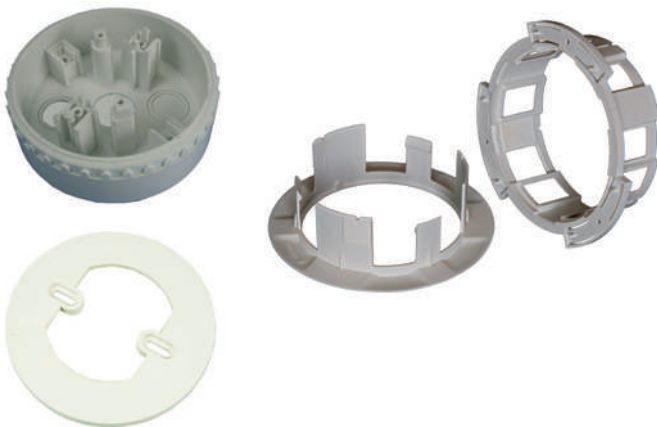

The Time Saver Ceiling Tile Adaptor is used with the 4" snap fit base and consists of three parts, a bezel and clamp that are fitted to the ceiling tile and a back-box that carries the detector and base assembly. It is available as a complete unit or alternatively, the back-box can be ordered separately, as can the bezel and clamp assembly. Ordering the parts separately may be preferred if there is an extended period before the false ceiling is installed e.g. "shell and core" projects. Requires a 127mm diameter hole. The CTA adaptor plate allows the Time Saver Ceiling Tile Adaptor to be used with other devices such as the AV Base, 802SB or Mini Firecryer.

Features

- Cuts installation time by 30%
- Commission the system before the suspended ceiling is installed
- Suitable for ceiling tiles from 1mm to 30mm thick
- Made from flame retardant material
- No additional back-box is required
- Time saver is designed for use with a new snap-fit 4" detector base
- Adaptor available for use with the AV base & other devices

Order Codes

517.050.060	Ceiling Tile Adaptor Kit consists of 1 x 517.050.056 and 1 x 517.050.057
517.050.056	CTA-BB CTA Back Box
517.050.057	CTA-BC CTA Bezel and Clamp
517.050.058	CTA-AP CTA Adaptor Plate

1.30

Addressable Detector Bases

4B-6A 4" to 6" Adaptor



The 4B-6A 4" to 6" Adaptor is designed for use with U.S. style 6" electrical back boxes and provides a flush architectural trim between the electrical box and the 4B-C 4" continuity base. It can also be fixed directly to a ceiling and used to conceal marks left when older, large diameter detectors are replaced with MZX Technology.

Features

- Adapts 6" electrical boxes to fit the 4B-C 4" continuity base
- Architectural trim for neat appearance
- Concealed fixings
- Use to conceal marks left by old detectors when replaced by MZX Technology

Order Code

517.050.054 4B-6A 4" to 6" Base Adaptor

Functional Detector Bases MKII Sounder Base



A low current range of sounder bases for use with Conventional and Addressable Fire Alarm Control Panels.

Features

- Manufactured to EN54 part 3
- Integral sounder and detector base
- Volume and tone adjustable after installation
- Low Power Synchronisation
- Do not require use of a standard base (maybe installed directly onto a standard besa box)

Order Codes

516.800.911 901SB Universal Sounder Base
516.800.913 812SB MZX Loop Powered UL Sounder Base
517.050.022 Volume Pot Spare Cover (1 sheet of 144)
517.050.005 4" Detector Base Locking Pin Kit (PK100)

P80AVB & P81AVB Addressable Sounder VAD Bases



Sounders are considered as the most important of all the alarm devices. It is a mandatory requirement that sounders are used as an integral part of the fire detection and alarm system.

VADs are used to supplement sounders, providing an effective means of alerting and evacuating occupants of the building, as part of its fire safety strategy.

The P80AVB and P81AVB are addressable sounder bases with a Visual Alarm Device (VAD) specifically for use with the ZETTLER addressable detectors. The bases are available as fire alarm sounders with Visual Alarm Device in two power outputs, standard and high. The high power option provides more coverage for the VAD compared to standard. Each has an address so they can be monitored and controlled from the fire alarm control panel, which is independent of the detector fitted to the base. The power and communications for the sounder, VAD and detector are provided by the two-wire digital loop. This helps to reduce installation costs as no additional wiring is required.

EN54-23 now provides clarity by standardizing requirements, test methods and performance criteria of Visual Alarm Devices (VADs) and ensures all device parameters are measured in a uniform manner throughout Europe.

Main Requirements from EN54-23 are:

- The coverage volume (i.e. volume within which required illumination is achieved) must be stated on the product or supporting documentation.
- The VAD should meet the requirement for coverage volume of at least one of the following categories: W (Wall), C (Ceiling), O (Open Class).
- Required illumination of 0.4 lux on a surface perpendicular to the direction of the light emitted from the VAD.
- Rate of flash should be stated between 0.5Hz & 2Hz.
- The devices must be classified as Type A, indoor and Type B, outdoor.

Features

- A compact and discrete solution
- VAD approved to EN54-23 with two ranges, standard power and high power available
- High power option provides a larger VAD coverage volume compared to standard
- Reflective Sound Monitoring (RSM)
- Reflective Light Monitoring (RLM)
- Automatic self-test
- Shorter light pulse for faster response
- Optimise the system design for lowest power requirements and lowest cost installation
- Triple light source
- One point of installation for detector, sounder and visual indicator with no additional wiring
- Independent addressable control of the sounder and beacon
- Built-in line isolator
- Select the tone, volume and flash rate using panel configuration software
- 15 selectable tones. Allows users to select the tone with which they are most familiar.
- Realistic conventional bell tone
- 2 selectable volumes
- 2 selectable flash rates
- Different tones can be used for fire alarm and class change
- VADs and sounders are synchronised over the entire loop
- A locking pin supplied with the base which prevents the unauthorized removal of the detector
- Provides an EN54-23 approved upgrade path

Order Codes

- | | |
|-------------|---|
| 576.080.006 | P80AVB Addressable Base Sounder VAD Standard Power |
| 576.080.014 | P81AVB Addressable Base Sounder VAD High Power |
| 557.080.001 | B-CAP Blanking Cap For Sounder / VID / VAD Bases White |
| 557.080.002 | A-CON Conduit Adaptor For Sounder / VID / VAD Bases White |

1.32

Addressable EN-54 Visual Alarm Detector Bases

Technical Information

	P80AVB	P81AVB
Coverage Volume Code:	C-3-8	C-3-15
Devices per Loop:	Up to 86 (*)	Up to 54 (*)
Flash Rate:	0.5 / 1Hz	0.5 / 1Hz
Dimensions (Diameter x H):	135x45mm	135x45mm
Sound Output @ 1m:	Up to 90dBA	Up to 90dBA
Body Colour:	Clear	Clear
Flash Colour:	White	White
IP Code:	IP21C	IP21C
Approvals:	EN54-3, 23, 17	EN54-3, 23, 17

(*) Full intensity VAD with sounder at high volume, 1 A loop.
Loop quantities are for guidance only and should be verified with the loop calculator.

Wall Category

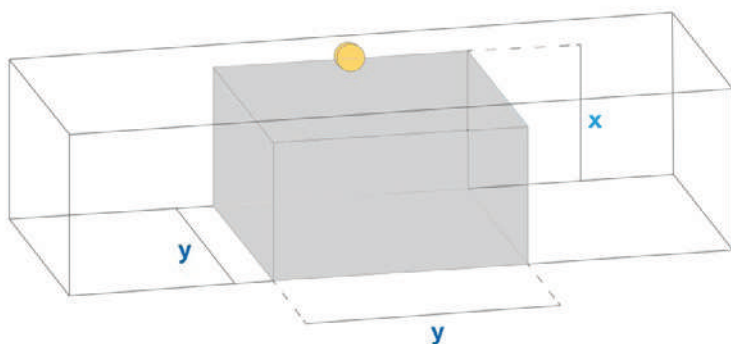

Coverage volume code:

W – (x) - (y)

W = wall mounted

x = maximum mounting height

y = length and width in metres of the cubic volume covered (to a minimum level of 0.4 lux) when the device is mounted to the wall at a height of **x**

Ceiling Category

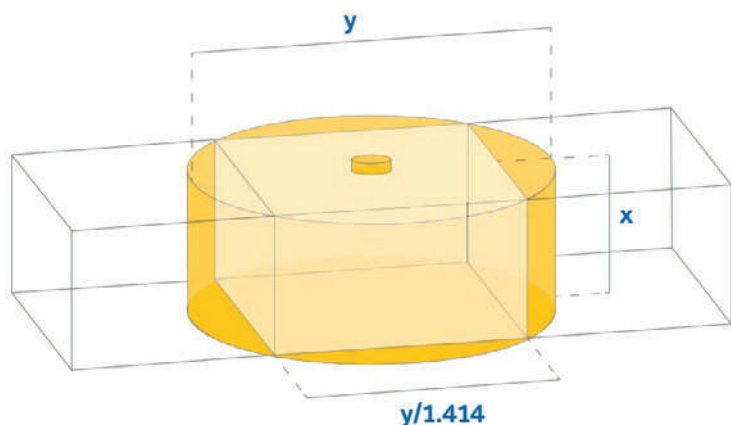

Coverage volume code:

C – (x) - (y)

C = wall mounted

x = maximum mounting height

y = diameter in metres of the cylindrical volume covered (to a minimum level of 0.4 lux) when the device is mounted to the ceiling at a height of **x**

Open Class Category

The coverage volume and its shape are specified by the manufacturer and include mounting position and orientation alongside any restriction on the mounting height.

P80SB & P80AIB Addressable Sounder Base and Addressable Sounder VID Base



Sounders are considered as the most important of all the alarm devices. It is a mandatory requirement that sounders are used as an integral part of the fire detection and alarm system.

VIDs are generally used as a supplementary indication to raise situational awareness. But, when an event occurs, they cannot be used as the only means to alert people to a potential hazard.

The P80SB is an addressable sounder base specifically for use with the ZETTLER addressable detectors. The base incorporates a fire alarm sounder that carries its own address so it can be monitored and controlled from the fire alarm control panel, which is independent of the detector fitted to the base. Both power and communications for the sounder and detector are provided by the two-wire digital loop. This helps to reduce installation costs as no additional wiring is required. Additionally, the P80AIB houses an addressable LED beacon to provide a visual indicator otherwise known as a VID.

EN54-23 now provides clarity by standardizing requirements, test methods and performance criteria of Visual Alarm Devices (VADs) and ensures all device parameters are measured in a uniform manner throughout Europe.

Main Requirements from EN54-23 are:

- The coverage volume (i.e. volume within which required illumination is achieved) must be stated on the product or supporting documentation.
- The VAD should meet the requirement for coverage volume of at least one of the following categories: W (Wall), C (Ceiling), O (Open Class).
- Required illumination of 0.4 lux on a surface perpendicular to the direction of the light emitted from the VAD.
- Rate of flash should be stated between 0.5Hz & 2Hz.
- The devices must be classified as Type A, indoor and Type B, outdoor.

Features

- A compact and discrete solution
- One point of installation for detector, sounder and visual indicator with no additional wiring
- Reflective Sound Monitoring (RSM)
- Light is electronically monitored by the control panel
- Automatic self-test
- Independent addressable control of the sounder and beacon
- Built-in line isolator
- Select the tone, volume and flash rate using panel configuration software
- 15 selectable tones. Allows users to select the tone with which they are most familiar
- Realistic conventional bell tone
- 4 selectable volumes
- 2 selectable flash rates
- Different tones can be used for fire alarm and class change
- VIDs and sounders are synchronised over the entire loop
- A locking pin supplied with the base which prevents the unauthorized removal of the detector
- Replace legacy LPSB3000 and LPAV3000

Order Codes

576.080.002	P80SB Addressable Base Sounder
576.080.010	P80AIB Addressable Base Sounder VID
557.080.001	B-CAP Blanking Cap For Sounder / VID / VAD Bases White

1.34

Addressable EN-54 Visual Alarm Detector Bases

Technical Information

	P80SB	P80AIB
Devices per Loop:	Up to 231 (*)	Up to 149 (**)
Flash Rate:	N/A	0.5 / 1Hz
Dimensions (Diameter x H):	114x45mm	114x45mm
Sound Output @ 1m:	Up to 90dBA	Up to 90dBA
Body Colour:	White	Clear
Flash Colour:	N/A	Red
IP Code:	IP21C	IP21C
Approvals:	EN54-3, 17	EN54-3, 17

(*) Sounder at high volume, 1 A loop.

(**) Beacon at 0.5 Hz with sounder at high volume, 1 A loop.

Loop quantities are for guidance only and should be verified with the loop calculator.

Wall Category

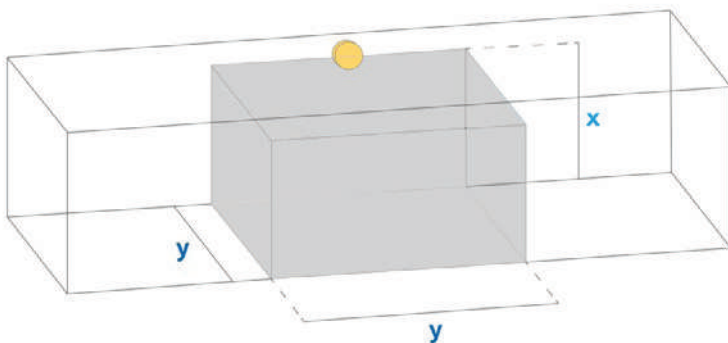

Coverage volume code:

W – (x) - (y)

W = wall mounted

x = maximum mounting height

y = length and width in metres of the cubic volume covered (to a minimum level of 0.4 lux) when the device is mounted to the wall at a height of **x**

Ceiling Category

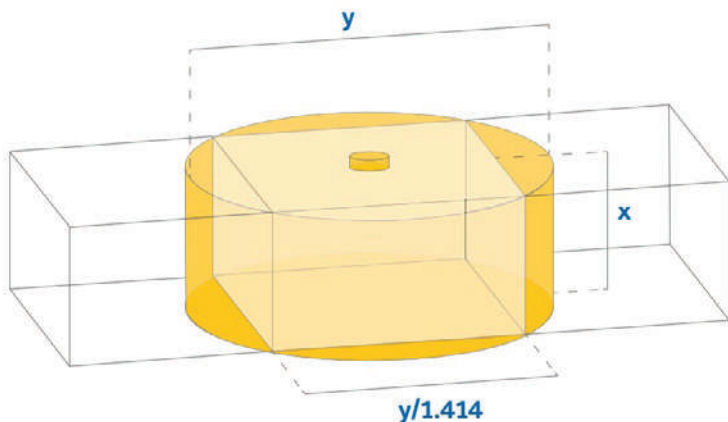

Coverage volume code:

C – (x) - (y)

C = wall mounted

x = maximum mounting height

y = diameter in metres of the cylindrical volume covered (to a minimum level of 0.4 lux) when the device is mounted to the ceiling at a height of **x**

Open Class Category

The coverage volume and its shape are specified by the manufacturer and include mounting position and orientation alongside any restriction on the mounting height.

80DSB Detector Sounder Base Detector Activated Sounder Base



Sounders are considered as the most important of all the alarm devices. It is a mandatory requirement that sounders are used as an integral part of the fire detection and alarm system.

The 80DSB is a detector base specifically for use with the ZETTLER addressable detectors.

The base incorporates a fire alarm sounder that is activated directly by the detector.

EN54-23 now provides clarity by standardizing requirements, test methods and performance criteria of Visual Alarm Devices (VADs) and ensures all device parameters are measured in a uniform manner throughout Europe.

Main Requirements from EN54-23 are:

- The coverage volume (i.e. volume within which required illumination is achieved) must be stated on the product or supporting documentation.
- The VAD should meet the requirement for coverage volume of at least one of the following categories: W (Wall), C (Ceiling), O (Open Class).
- Required illumination of 0.4 lux on a surface perpendicular to the direction of the light emitted from the VAD.
- Rate of flash should be stated between 0.5Hz & 2Hz.
- The devices must be classified as Type A, indoor and Type B, outdoor.

Features

- A compact and discrete solution
- One point of installation for detector and sounder with no additional wiring
- Low power with up to 250 sounders on a single loop
- Provides uncompromised system design solutions
- Simple to select the tone and volume using switches
- No special training or tools needed
- 9 selectable tones
- 4 selectable volumes
- A locking pin supplied with the base which prevents the unauthorized removal of the detector
- Replaces legacy 802SB and it is compatible with 800 series detectors. Can be used for service and repair or as part of a planned upgrade path

Order Codes

- 576.080.001 80DSB Zettler Detector Base Sounder
557.080.001 B-CAP Blanking Cap for Sounder /VID / VAD Bases White
557.080.002 A-CON Conduit Adaptor for Sounder /VID / VAD Bases White

Technical Information

	P80DSB
Devices per Loop:	Up to 250 (*)
Dimensions (Diameter x H):	114x45mm
Sound Output @ 1m:	Up to 90dBA
Body Colour:	White
IP Code:	IP21C
Approvals:	EN54-3, 17

(*) Sounder at high volume, 1 A loop.
Loop quantities are for guidance only and should be verified with the loop calculator.

1.36

Addressable Detector Base Ancillaries

801RIL - Remote Indication LED



All detector bases have the ability to drive a remote LED in the event that the installed position of the detector is not easily visible. The 801RIL is primarily designed for LPCB influenced markets but is compatible with all 800 Series detectors.

Features

- UK Single gang mounting
- High intensity red LED

Order Code

516.800.908 801RIL remote indication LED

801HL - Remote Indication Lamp

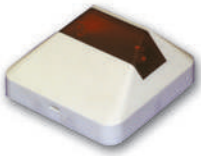

The 801HL remote indicator lamp provides a larger indicator for use in place of the RIL when longer distances are involved or in VdS influenced markets. Typically used to indicate the source of an alarm in buildings with long corridors eg. Hotels, hospitals, apartments.

Order Code

516.800.909 801HL indication lamp

4B-EM 4" Euro Mount



The euro-mounting base provides a matching back box, which allows the 4" bases to be ceiling mounted with conduit entries for standard 18 and 21mm conduit.

Features

- 2 x 18 mm conduit entries
- 2 x 21 mm conduit entries
- Fits all 4" Bases
- Accepts up to 8 accessory terminals

Order Codes

517.050.052 4B-EM 4" Euro Mount
517.050.612 Base Accessory terminal kit (pack of 10)

4B-DHM Deck Head Mounting



For humid and environmentally challenging applications such as marine or offshore installations, the 4B-DHM deck head mount provides a sealed waterproof mounting which protects the electrical connections in the base. It can be screwed, bolted or welded to the deckhead. Supplied with 1 terminal. If more are required, use the optional base accessory terminal kit.

Features

- 4 x 20 mm gland entries
- Fits ALL 4" bases
- IP55 with supplied gasket

Order Codes

517.050.051	4B-DHM Deckhead Mount
517.050.612	Base accessory terminal kit (pack of 10)

Protective Detector Cage



Robust steel protective cage for Series 800 detector ranges using the 5" bases. Ideal for schools and sports halls or whenever detectors need protection.

Strong coated steel construction with 4 point fitting.

Order Code

517.050.614	CW-5B Detector Cage
-------------	---------------------

Protective Detector Sounder Base Cage



White powder coated steel protective cage for Series 800 Detectors fitted with a sounder base. Internal dimensions: 120mm dia x 80mm deep.

Order Code

517.050.011	Steel Protective Detector Cage
-------------	--------------------------------

1.38

Addressable Detector Base Ancillaries

DPK6 Duct Probe



The DPK6 duct probe units have been developed to detect smoke in ventilation ducts. They offer significant benefits in terms of performance and installation. The system comprises a single duct probe tube and housing specially designed for optimum airflow through the smoke detector and suitable for use in incoming, outgoing and circulation air ducts of ventilation and conditioning systems. The duct probes can operate across a wide range of airflow speeds and are designed to comply with prEN 54-27 and VdS.

Unlike more traditional duct probe units that employ an inlet and exhaust tube with sampling holes, the DPK6 unit uses a highly efficient single sampling tube that is slotted along its length. This allows the sampling tubes to be cut to the desired length whilst maintaining maximum efficiency.

In order to reduce the time required to test the duct probe detector during routine maintenance, an aperture is provided that allows aerosol test gas to be directed at the detector without having to dismantle the unit.

Accessories

3 lengths of the duct probe tubes are available. The tube is made of aluminium and can easily be shortened to suit the span of the air duct. Where the unit is mounted on insulated or circular air ducts, the DPK6-MB mounting bracket is required.

Features

- DPK6 for use with Generation 6 multi-sensor detectors 850PH and 830PH with built-in 4B-C
- 4" Continuity Base
- Designed to comply with prEN 54-27
- One-pipe air sampling system
- Patented venturi pipe and duct housing
- Test hole on cover
- Simple installation
- Simple service and maintenance

Order Codes

517.025.056	DPK6 Duct Probe with 4B-C 4" Continuity Base
517.025.058	DPK6-60 - Duct Probe Tube 60 cm
517.025.059	DPK6-150 - Duct Probe Tube 150 cm
517.025.060	DPK6-280 - Duct Probe Tube 280 cm
517.025.061	DPK6-MB - Duct Probe Mounting bracket
517.025.055	DPKF - Filter

APM800 Addressable Power Supply Monitor



The APM800 is an MZX addressable power supply monitoring module which is usually used with the PSM800/820/821 power supply module to make an addressable power supply. The APM800 is designed to fit to studs on the top of the PSM800/820/821. The APM800 monitors the PSM800/820/821 for mains failure, earth fault, battery charger fault and battery fault. It can reset the PSM800/820/821 resettable 24Vdc output and initiate a battery test which then reports battery voltage and current to the controller.

Technical Information

EMC/RFI:	Equal or exceeds EN50081-1 & EN50130-4
Operating Temp:	-25°C to +70°C
Relative Humidity:	Up to 95% RH non-condensing
Dimensions:	24H x 127W x 57D mm
Weight:	794g

Order Code

557.202.027	APM800 addressable power supply monitor
-------------	---

BDM800 Beam Detector Module - Loop Powered



The BDM800 is designed to interface the FIRERAY reflective beam detectors to the MZX Digital Addressable Loop. The BDM800 provides power from the loop, monitors the Fire and Fault outputs of the detector and also monitors inter-connections for open and short circuit faults. Supplied fitted in a standard double gang ancillary housing, the BDM800 greatly simplifies the wiring normally associated with beam detection.

The considerable cost of providing local power supplies that satisfy the stringent requirements of BS5839 part 1 is eliminated.

Features

- Power beam detectors directly from the MZX loop
- Reduced wiring and installation costs
- Monitors beam detector for fire and fault
- Monitored for open / short circuit faults
- LPCB and VdS approved (pending)
- Can be installed to BS5839 part 1 2002
- On board LED indicates polling and active
- Use with reflective beams FIRERAY 50R or 100R for greater savings on installation
- Compatible with FIRERAY 2000 + FIRERAY 5000
- Optional BTM800 beam terminal termination module

Order Code

555.800.066	BDM800 Beam Detector Module c/w Cover
-------------	---------------------------------------

BTM Beam Termination Module



If it is necessary to site the BDM800 Beam Detector Module some distance from the beam detector itself, an optional BTM800 beam termination module is available to minimise and simplify the wiring. The BTM800 is housed in a standard double gang ancillary cover and has all the connections and components required to minimise installation time.

Features

- Simplifies the wiring between the Beam detector and BDM800
- Allows BDM800 to be sited up to 40m from the beam detector

Order Code

555.800.067	BTM800 Beam Terminal Module c/w Cover
-------------	---------------------------------------

1.40

Addressable MZX Input/Output Modules

CIM800 Contact Input Module

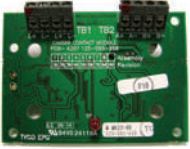

The CIM800 is a flexible addressable input-monitoring device that fits in the standard ancillary housings. The CIM800 provides two inputs to current MZX panels though this can be implemented as two separately wired spurs (Style B) or as a loop (Style A). Both spur and loop input wiring can be configured to monitor normally open or normally closed inputs. In addition both can be configured to initiate an alarm or short circuit fault message in the event of a short circuit on normally open monitoring circuits.

Technical Information

EMC/RFI:	Equal or exceeds EN50081-1 & EN50130-4
Operating Temp:	-25°C to +70°C
Relative Humidity:	Up to 95% RH non-condensing
Dimensions:	14H x 148W x 87D mm
Weight:	100g
EOL & Monitor Resistor:	10k Ohms

Order Codes

555.800.002	CIM800 Contact input monitor
555.800.032	CIM800 Module c/w Front Cover

DDM800 Universal Fire and Gas Module

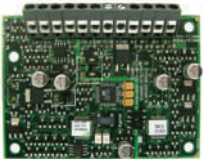

The DDM800 provides the ability to connect and interface 2 zones of conventional 2 wire fire detectors or two 4-20mA sensors to the MZX Fire alarm controllers.

When used to interface conventional detection devices, Open & Short circuit and device removal monitoring is provided. Intrinsically safe (IS) detection is supported when used with a galvanic isolator. An integral line isolator is incorporated in the module. Loop powered or 24vdc operation.

The 4-20mA interface can be used to monitor devices such as gas detectors, temperature alarms or any 4-20mA interfaced device.

The DDM800 is compatible with MZX Consys version 15 or later.

Technical Information

EMC/RFI:	Equal or exceeds EN61000-6-3 & EN50130-4
Operating Temp:	-25°C to +70°C
Relative Humidity:	Up to 95% RH non-condensing

Order Codes

577.800.006	DDM800 Universal Fire and Gas Module
577.800.036	DDM800 Universal Fire and Gas Module c/w front cover
577.800.056	DDM800 Universal Fire and Gas Module housed in IP55 D800 Enclosure
557.800.057	DDM800 Detector Removal End of Line Resistor (pack of 10)

DIM800 Detector Input Module

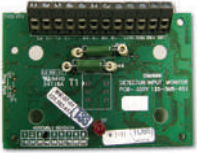

The DIM800 is designed to power and monitor a circuit of low voltage conventional detectors and callpoints. The detection circuit is powered from an external 24V d.c. supply and is reset by the MZX panel. The DIM800 monitors the external 24Vdc and provides a fault signal if it is lost. The input detection circuit can be wired as one or two spur circuits (Class B), one loop configured circuit (Class A) or one 4 wire detection circuit. The module is designed to be compatible with most conventional detection products. Compatibility has been tested to date on the following products: M300 Series, M601 Series, S100 Series, H Series, S231F, S231F+ & CP200.

Technical Information

EMC/RFI:	Equal or exceeds EN50081-1 & EN50130-4
Operating Temp:	-25°C to +70°C
Relative Humidity:	Up to 95% RH non-condensing
Dimensions:	14H x 148W x 87D mm
Weight:	100g

Order Codes

555.800.012	DIM800 Detector input monitor
555.800.042	DIM800 Module c/w front cover

HVR800 High Voltage Relay Module



The HVR800 module is a non-addressable device which allows a low current mains rated relay to switch up to 10A. Alternatively a low voltage drive signal such as that provided by the RIM800 or 80 way mimic can be used to switch the integral mains relay via the opto-isolated input.

Technical Information

EMC/RFI:	Equal or exceeds EN61000.6.3 & EN50130-4
Operating Temp:	-25°C to +70°C
Relative Humidity:	Up to 95% RH non-condensing
Dimensions:	26.5H x 42W x 74D mm
Relay contacts:	Up to 10A @ 250Vac

Order Codes

568.800.004	HVR800 high voltage relay
568.800.034	HVR800 in isolated D800 housing

LIM800 Line Isolator Module



The LIM800 Ancillary Line Isolator Module is designed to be used on all MZX addressable loops. It monitors the line condition and upon detection of a short circuit isolates the affected section whilst allowing the rest of the addressable loop to function normally. The LIM800 ensures that on a looped addressable system a short circuit fault cannot disable more detection devices than would be lost on a conventional non-addressable system in accordance with BS5839 Part 1.

Technical Information

EMC/RFI:	Equal or exceeds EN50081-1 & EN50130-4
Operating Temp:	-25°C to +70°C
Relative Humidity:	Up to 95% RH non-condensing
Dimensions:	14H x 148W x 87D mm
Weight:	100g

Order Codes

545.800.004	LIM800 Ancillary Line Isolator Module
545.800.033	LIM800 Ancillary Line Isolator Module c/w front cover

1.42

Addressable MZX Input/Output Modules

LPS800 Loop Powered Sounder Module

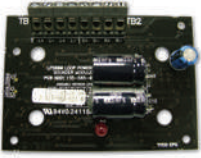

The LPS800 provides a single monitored sounder output circuit with up to 75 mA of power sourced from the MZX panel.

NOTE: Each MZX Digital Loop can provide up to 495mA for loop powered sounders and modules.

Technical Information

EMC/RFI:	Equal or exceeds EN61000.6.3 & EN50130-4
Operating Temp:	-25°C to +70°C
Relative Humidity:	Up to 95% RH non-condensing
Dimensions:	14H x 148W x 87D mm
Weight:	100g
Output Rating:	75 mA @ 24 Vdc max

Order Codes

577.800.011	LPS800 Loop Powered Sounder module
577.800.041	LPS800 Module c/w front cover

MIM800 Mini-Input Module



The MIM800 is a small MZX addressable module designed for monitoring a single input circuit. The MIM800 can monitor normally open or normally closed inputs and provides open and short circuit monitoring of the line. The MIM800 is designed for fitting in small devices such as flow switches, special detection devices and explosion proof callpoints. A variant of the MIM800 is used in all callpoints and pullstations.

Technical Information

EMC/RFI:	Equal or exceeds EN50081-1 & EN50130-4
Operating Temp:	-25°C to +70°C
Relative Humidity:	Up to 95% RH non-condensing
Dimensions:	13H x 48W x 57D mm
Weight:	100g
EOL Resistor:	200 Ohm
Monitor Resistor:	100 Ohm

Order Code

555.800.001	MIM800 mini-input module
-------------	--------------------------

MIO800 Multi-Input Output Module



The MIO800 is a general purpose interface module. It allows multiple input and output connections to be made between external equipment and the MZX Digital loop. Three inputs and four outputs are provided. Each input and output can be programmed independently using the MZX Consys configuration tool to provide customised functionality.

An IP55 rated D800 style housing is used as the standard enclosure with the option of a DIN-rail mounting kit for in-cabinet installations.

Order Codes

555.800.065	Multi I/O Module
557.201.401	D800 Ancillary Housing
557.201.303	Din Rail Mounting Kit

Features

- Normally open or normally closed inputs
- Inputs monitored for open or short circuit faults.
- STYLE B (short circuit gives an alarm) or STYLE C (short circuit gives a fault) selectable for inputs
- Provides four digital outputs
- All four outputs can drive a HVR800 module
- Two outputs have both volt free change over contacts and HVR Drivers

Technical Information

Operating Temp:	-25°C to +70°C
Storage Temperature:	-40°C to +80°C
Relative Humidity:	Up to 95% RH non-condensing
Dimensions (HxWxD)	Module - 72 x 110 x 18 mm Boxed - 124.5 x 166.5 x 84.5 mm
Weight:	Module - 70g Boxed - 271g
Relay contact rating:	DC - 2A @ 24V dc

Quad Input/Output Module (QIO850)

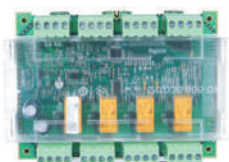

The Quad Input/Output Module connects directly to the MZX Digital loop and provides four change over relay outputs, four High Voltage Relay (HVR) outputs and four monitored inputs. It is loop powered and therefore does not need a power supply*, however it can monitor the presence of a local 24Vdc or 48Vdc power supply.

Order Code

555.800.071	Quad Input/Output Module (QIO850)
-------------	-----------------------------------

*** A 24Vdc power supply will be required if the module is controlling HVR's switching 240Vac.**

Features

- Four change over relay outputs and four monitored inputs each individually programmable for a wide range of applications
- Four HVR drivers*
- Inputs can monitor normally open or normally closed contacts
- The relay contacts are monitored and users are alerted to "output stuck" conditions
- Uses 2 addresses when configured for 2 inputs with 2 associated outputs
- Uses 4 addresses when configured for 4 inputs with 4 associated outputs
- Uses 8 addresses when configured for 4 inputs and 4 independent outputs
- Compact DIN rail mount design saves space
- Lower installation costs than individual modules
- Built-in line isolators improve fault tolerance
- Status LED's provide rapid diagnostics
- Two way IR communication to the 850EMT programming tool speeds up commissioning
- Monitors input power supply for improved system integrity
- VdS and CPD approved to EN54-17, EN54-18 and EN54-13

1.44

Addressable MZX Input/Output Modules

Quad Monitored Output Module (QMO850)

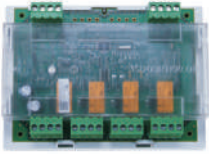

The Quad Monitored Output Module connects directly to the MZX Digital loop and requires a 24Vdc or 48Vdc power supply. It provides four monitored outputs for connection to conventional sounder circuits or auxiliary relays.

Order Code

555.800.070 Quad Monitored Output Module (QMO850)

Features

- Four polarity reversal monitored outputs
- Class A or Class B wiring for versatility
- Uses 2 addresses when configured for 2 outputs
- Uses 4 addresses when configured for 4 outputs
- Compact DIN rail mount design saves space
- Lower installation costs than individual modules
- Built-in line isolators improve fault tolerance
- Status LED's provide rapid diagnostics
- Two way IR communication to the 850EMT programming tool speeds up commissioning
- Monitors input power supply for improved system integrity
- VdS and CPD approved to EN54-17, EN54-18 and EN54-13

Quad Relay Output Module (QRM850)

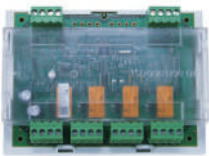

The Quad Relay Output Module connects directly to the MZX Digital loop and provides four change over relay outputs or four High Voltage Relay (HVR) outputs. It is loop powered and therefore does not need a power supply*, however it can monitor the presence of a local 24Vdc or 48Vdc power supply.

Order Codes

555.800.073 Quad Relay Output Module (QRM850)

*** A 24Vdc power supply will be required if the module is controlling HVR's switching 240Vac.**

Features

- Four change over relay outputs each individually programmable for a wide range of applications
- Four HVR drivers*
- The relay contacts are monitored and users are alerted to "output stuck" conditions
- Uses 2 addresses when configured for 2 outputs
- Uses 4 addresses when configured for 4 outputs
- Compact DIN rail mount design saves space
- Lower installation costs than individual modules
- Built-in line isolators improve fault tolerance
- Status LED's provide rapid diagnostics
- Two way IR communication to the 850EMT programming tool speeds up commissioning
- Monitors input power supply for improved system integrity
- VdS and CPD approved to EN54-17, EN54-18 and EN54-13

Quad Module Technical Information

	QIO850	QMO850	QRM850	HOUSING FOR QUAD I/O MODULES
System Compatability	Any MZX Fire Alarm Controller configured with MZX Consys Version 20.0 or later			N/A
Mechanical				
Dimensions (HxWxD)	103 x 134 x 49 mm			170 x 254 x 90 mm
Material				Grey Polystrene similar to RAL 7035 (Base). Transparent Polycarbonate (Cover).
Cable Entry Knockouts				24 x M20, 4 x M25/32, 4 x M32/40
Electrical				
Voltage	40VDC			
Current	1.1 mA (standby), 5.9 mA (alarm)	2.1 mA (standby), 6.7 mA (alarm)	1.1 mA (standby), 5.9 mA (alarm)	
Wire Size	0.5mm ² to 2.5 mm ²			
Output Circuit (Relay Contacts)	Nominal switching capacity 2 A at 30 VDC (resistive load), Maximum switching power 60 W, 125 VA (resistive load)			
Auxiliary Voltage Input	Auxiliary voltage 24 VDC to 55 VDC (threshold voltage for auxiliary voltage fault indication: 18 VDC +/- 1VDC). Auxiliary voltage 48 VDC to 55 VDC (threshold voltage for auxiliary voltage indication 36 VDC +/- 2 VDC).	Auxiliary voltage 24 VDC to 55 VDC (threshold voltage for auxiliary voltage fault indication: 18 VDC +/- 1.5 VDC). Auxiliary voltage 48VDC to 55VDC (threshold voltage for auxiliary voltage indication: 36VDC +/- 2.5VDC). Wiring monitoring (threshold resistance for auxiliary voltage fault indication 50 ohms +/- 5 ohms).	Auxiliary voltage 24 VDC to 55 VDC (threshold voltage for auxiliary voltage fault indication: 18 VDC +/- 1VDC). Auxiliary voltage 48 VDC to 55VDC (threshold voltage for auxiliary voltage indication 36 VDC +/- 2 VDC).	
Environmental				
Operating Temperature	-25°C to +7°C			-25°C to +40°C
Storage Temperature	40°C to +80°C			
Operating Humidity	Up to 95% Non condensing			100% at 25°C (SHORT TERM)
Ingress Protection	IP66			
Electromagnetic Compatability	EN50130-4 for immunity EN61000-6-3 for emissions			N/A
Approvals	EN54-17, EN54-18 and EN54-13			N/A

1.46

Addressable MZX Input/Output Modules

IP66 Housing for Quad I/O Modules



A polystyrene/polycarbonate IP66 rated housing pre-fitted with a din rail for mounting either 1 x Quad Input/Output Module (QIO850), or 1 x Quad Monitored Output Module (QMO850) or 1 x Quad Relay Output Module (QRM850) complete with a transparent front cover.

Order Code

557.201.410 IP66 Housing for Quad I/O Modules

Features

- Ingress Protection rating of IP66
- Polystyrene/polycarbonate construction hence will not corrode
- Supplied pre-fitted with a din rail to enable the Quad Modules to snap fit into the housing
- Transparent front cover allows the status LEDs of the Quad Module to be viewed without removing the cover and also allows two way IR communication with the 850EMT programming tool
- Supplied with M20/M25/M32/M40 cable entry knockouts

RIM800 Relay Interface Module



The RIM800 provides a single programmable relay output from the MZX DIGITAL addressable loop which can be programmed for a variety of applications including signalling fire conditions to plant, machinery, fire doors, dampers & security systems. The RIM800 relay coil is monitored. The RIM800 relay contact is rated for 2A @ 24V d.c. but can be used to switch mains voltage when used with the HVR800. This unit has two opto-isolated terminals specifically for driving the HVR800.

Technical Information

EMC/RFI:	Equal or exceeds EN61000.6.3 & EN50130-4
Operating Temp:	-25°C to +70°C
Relative Humidity:	Up to 95% RH non-condensing
Dimensions:	14H x 148W x 87D mm
Weight:	100g
Quiescent Current:	200µA
Relay contacts:	2A @ 24 Vdc

Order Codes

568.800.003	RIM800 relay interface module
568.800.033	RIM800 Module C/W Front Cover

SB520 Sounder Booster Module



The SB520 sounder booster module enables the SNM800 to drive circuits with higher currents whilst maintaining the reverse polarity integrity line monitoring.

Technical Information

EMC/RFI:	Equal or exceeds EN61000.6.3 & EN50130-4
Operating Temp:	-25°C to +70°C
Relative Humidity:	Up to 95% RH non-condensing
Dimensions:	14H x 148W x 87D mm
Weight:	100g
Output Rating:	15 A @ 24Vdc /10A Max. per terminal (Non addressable)

Order Codes

577.001.023	SB520 Sounder Booster Module
577.001.033	SB520 Module c/w Front Cover

SIO800 Single Input/Output Module



The SIO800 Single Input/Output Module is designed to provide a monitored input and a volt free relay changeover output. It consists of an input for monitoring the status of a normally open contact and a single changeover relay contact. The relay is controlled by a command sent from the MZX Fire Controller via the addressable loop.

The state of the relay (activated, deactivated or stuck) is reported to the MZX Fire Controller. The LED may be turned ON or OFF by the controller during a relay activated condition.

Technical Information

EMC/RFI:	Product Family standard EN50130-4 in respect of Conducted Disturbances, Radiated Immunity, Electrostatic Discharge, Fast Transients and Slow High Energy. 61000-6-3 for Emissions.
Operating Temp:	-25°C to +70°C
Relative Humidity:	Up to 95% RH non-condensing
Dimensions:	14H x 148W x 87D mm
Weight:	105g

Order Codes

555.800.063	SIO800 Single Input/Output Module
555.800.064	SIO800 Single Input/Output Module c/w Front Cover

SNM800 Sounder Notification Module



The SNM800 is a remote addressable sounder circuit output device capable of switching sounder and speaker circuits up to 2A @ 24V d.c. or provide a monitored output facility for other applications. These can be used in addition to the two circuits provided as standard on most MZX detection panels. The SNM800 can support sounder circuits wired as a spur (Class B – Style Y) or in a loop configuration (Class A – Style Z).

Technical Information

EMC/RFI:	Equal or exceeds EN61000.6.3 & EN50130-4
Operating Temp:	-25°C to +70°C
Relative Humidity:	Up to 95% RH non-condensing
Dimensions:	14H x 148W x 87D mm
Weight:	100g
Output Rating:	2A @ 24 Vdc
EOL Resistor:	27k 1/2 W

Order Codes

577.800.005	SNM800 sounder notification module
577.800.035	SNM800 Module c/w Front cover

1.48

Addressable MZX Input/Output Modules

TM520 Timer Module



The TM520 provides two outputs that can be activated based on a delay time. If the key-switch on the module is activated or a predefined event within the control panel occurs, then a timed delay (Between 10 mins and 2 hours 10 mins) is started. When the delay reaches zero the TM520 outputs are activated. The unit sounds an internal buzzer and illuminates a red LED when the outputs are active and illuminates a yellow LED when the timer is counting down. The red LED and the buzzer will pulse 5 minutes before the end of the delay.

Technical Information

Powered: 24Vdc
Temperature Range: -20°C to +70°C
Operating Humidity: <95% RH
Dimensions: 87H x 148W x 14D mm

Order Code

557.180.423 TM520 Timer module - non addressable

The TM520 requires a separate 24V DC supply to operate. The module is not addressable and will therefore not take an address on the loop.

TSM800 Door Control Module



The TSM800 is used to control fire doors in accordance with BS7273 Part 4. When activated, either by a fire signal or by a fault or isolation within the fire door zone, the TSM800 will interrupt the supply to the door holders and the doors under control of the module will close. The module has the provision to monitor a contact to report to the fire controller if the door fails to close. The module also includes a built-in line isolator. This module requires MZX Consys 10 or later to function.

Technical Information

EMC/RFI: Equal or exceeds EN61000.6.3 & EN50130-4
Operating Temp: -25°C to +70°C
Relative Humidity: Up to 95% RH non-condensing
Dimensions: 14H x 148W x 87D mm
Weight: 100g
Relay Contacts: 2A @ 30Vdc

Order Code

555.800.069 TSM800 Door Control Module PCB

VIO800 MZX Vesda Interface



The VIO800 MZX Vesda Interface will enable all versions of the popular LaserPLUS Detectors and 7 relay versions of the Laser SCANNER Detectors to be interfaced directly to the MZX Digital detection loops. 3 configurable inputs and 1 output signal are available from the interface enabling it to integrate fully with the Vesda detector.

This module is designed to fit in bay one of the Vesda Detectors.

Order Code

516.018.014 VIO800 MZX VESDA Interface

MZX Compatible 4 Amp 24VDC Addressable PSU

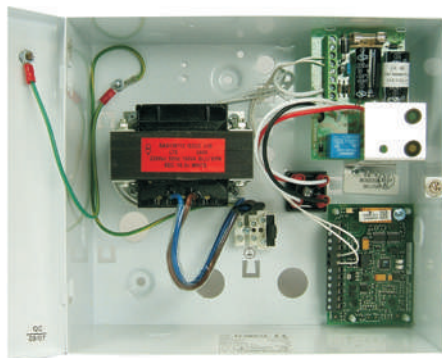

The MZX compatible ELM24TSM 4 Amp 24VDC Addressable Door Control & Power Supply Unit, is designed to provide monitoring and activation in compliance with the most stringent local door control standards.

This Door Holder PSU is interfaced to the MZX Panels via an integral TSM800 Door Control Module which is field mounted inside the Door Holder PSU and connects to the MZX Detector Loop.

Features

- Connects directly to the MZX Digital Loop
- Reduced installation time and cost since no external module is required
- Easier Programming and Commissioning – predefined in MZX Consys
- EN60950:2000 Compliant PSU
- EN50130-4:1996 & EN50081-1:1992 Compliant PSU
- Mains and Fault LED Indicator on front cover
- Output fuse protected
- 24VDC Voltage Door Release Relay
- Specifically designed for the safe actuation of release mechanisms for doors
- Satisfies the requirements of BS7273 Part 4 for category A actuation of Fire Doors
- Built in line isolator
- Self monitoring operation
- Approved to EN54-18 (Input/Output Devices) and EN54-17 (Line Isolators)

Technical Information

Input Voltage:	230Vac 50Hz
Output Voltage:	22-30 Vdc
Output Current:	4 Amps Continuous
Temperature:	-10°C to + 40°C
Relative Humidity:	95% RH
IP Rating:	IP41 (excluding rear face)
Material:	1.2 mm white powder coated steel
Dimensions:	200H x 230W x 80D mm

Order Code

558.004.011 ELM24TSM 4 Amp 24VDC Addressable Door Holder PSU

1.50

Addressable MZX Input/Output Modules

RS800-IP/GPRS IP Communication Module

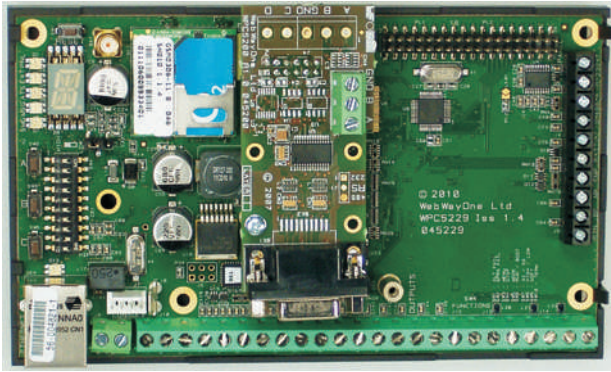

The RS800-IP/GPRS module connects to an individual or a network of PROFILE, MZX or ZX fire control panels to provide a cost effective, secure and robust IP (Internet Protocol) based communication platform for alarm signalling, fault reporting and a range of remote services.

The RS800-IP/GPRS module connects to the communication ports and relays of a fire control panel and converts the RS232 and digital data into IP data that can be transmitted over the internet.

Communication is dual path. The primary path is the client IP network, eliminating the additional cost of traditional PSTN telephone lines. Efficient, digital communication puts negligible demand on the network and ensures future compatibility as traditional analogue systems are phased out.

The GPRS mobile communication network is the secondary path and maintains communication in the event of a failure of the primary path.

Features

- A cost effective digital communication platform to enable a range of remote services
- Robust dual path transmission over the clients IT network and the GPRS network, ensures continuity of communication in the event of a failure
- Regular polling of the IP path and the GPRS path confirms successful end to end communication - a failure will be reported within 3 minutes
- Secure communication ensured by AES encryption with a 128 bit key and 256 bit hash code
- BRE approved to EN 54-21 for fire alarm transmission and fault warning routing equipment
- Supplied with an activated Telefonica roaming SIM
- All access is securely controlled and logged

Order Codes

557.202.090	RS800 Webway IP/GPRS
557.202.091	RS800 Webway IP
557.202.093	Enclosure for RS800
22-5049-10M	Webway High Gain Eng Pack, Antenna, SIM, 10m cable
22-5049-15M	Webway High Gain Eng Pack, Antenna, SIM, 15m cable
22-5054	Webway Smart Disc Eng Pack, Antenna with SIM

MZX Ancillary Housings

A variety of ancillary housings are available to fit the 800 Series MZX ancillaries. The standard sized modules are mechanically compatible with all options. LPCB approvals are with the M520 double gang cover plate or ancillary housings. The M520 double gang cover provides external access for the MZX SERVICE TOOL to plug into the ancillary module which is mounted in the cover. All options allow the ancillary to be programmed and tested when the cover is removed.

M520 Ancillary Cover



Order Code

517.035.007 M520 Ancillary Cover

M520 Ancillary cover for use with 800 series modules.
Will fit onto a MK style double gang back box.

D800 IP55 Ancillary Housing



Order Code

557.201.401 D800 IP55 Ancillary Housing

D800 IP55 ancillary housing (140W x 120H x 70D mm)
incorporates a window to view the module LED.

ANC-3 Ancillary Housing



Order Code

557.180.097.A ADT Branded

ANC-3 ancillary housing - for use with M800 ancillary
modules (can accommodate up to 3 M800 modules).
Dimensions 340W x 290H x 90D mm.

ANC-8 Ancillary Housing



Order Codes

557.180.096.A ADT Branded
557.180.095 STK8 stacking kit

ANC-8 ancillary housing for use with M800 ancillary
modules, houses 8 modules, expandable to 16 using the
STK8 stacking kit.. Dimensions 440W x 320H x 140D mm

1.52

Addressable MZX Ancillary Housings

DIN Rail Mounting Bracket



Order Code

547.004.002 DIN rail mounting bracket

DIN Rail mounting bracket enables any module which can be mounted to a M520 ancillary cover to be DIN rail mounted using this bracket.

Clip-on PCB mounting pillars are included. Will fit standard 35mm DIN Rail bracket.

QFB/2 Dry Lining Flush Mount Backbox



Order Code

517.035.015 QFB/2 Dry Lining Flush Mount MK backbox

QFB/2 Dry lining flush mount (for plasterboard etc) MK backbox for use with 800 Series addressable ancillaries using 517.035.007 cover.

K2214 ALM Metal Surface Mount Backbox



Order Code

517.035.011 K2214 ALM Metal Surface Mount MK backbox

K2214 ALM Metal surface mount MK backbox for use with 800 Series addressable ancillaries using 517.035.007 cover.

K2142 White Plastic Surface Mount Backbox



Order Code

517.035.010 K2142 White Plastic Surface Mount MK backbox

K2142 White plastic surface mount MK backbox for use with 800 Series addressable ancillaries using 517.035.007 cover.

8621C Steel Flush Mount Backbox



Order Code

517.035.014 8621C Steel Flush Mount MK backbox

8621C Steel flush mount MK backbox for use with 800 Series addressable ancillaries using 517.035.007 cover.

Ancillary Housing Technical Information

Product Code	MK Ref	Mounting Type	Dimensions (HxWxD)	Knock-Outs	Earth Screw	Material
517.035.011	K2214	Surface	146x86x40 mm	1x20mm rear 7x20mm sides	Yes	Steel
517.035.010	K2142	Surface	146x86x34 mm	One rear (25x35mm)	N/A	Plastic
517.035.014	8621C	Flush	132x72x26 mm	4x20mm rear 12x20mm sides	Yes	Steel
517.035.015	QFB/2	Flush Dry Lining	146x85x38 mm	2 top & bottom	N/A	Plastic

1.54

Addressable MZX Callpoints

MCP Series Callpoints



A comprehensive range of addressable callpoints. All the callpoints are designed to enable an alarm signal to be given by breaking a glass element.

This operates a switch and is indicated by an LED indicator. If required, an optional transparent hinged cover may be installed to guard against accidental operation.

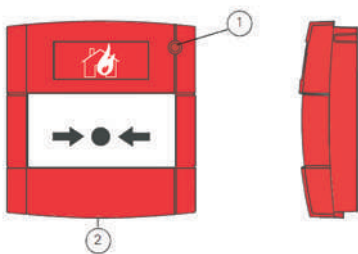

MCP820 Indoor Addressable Break Glass Callpoint
1 – Short Circuit Isolator Activation (Yellow) and Alarm Indicator LED (Red) - MCP versions only
2 – Test/Release Key Access

Features

- Integrated LED for easy identification of operation
- Surface or flush mounting
- Extensive range of digital addressable callpoints
- Test key facility, speeds maintenance visits
- Hazardous Areas models available (See Special Hazards Section)
- IP67 Waterproof models for external applications

Technical Information (Indoor and Outdoor)

Housing:	PC/ABS
Operating Temperature	Outdoor: -25°C TO +70°C Indoor: -10°C TO +55°C
Relative Humidity:	Up to 95% RH (non-condensing)

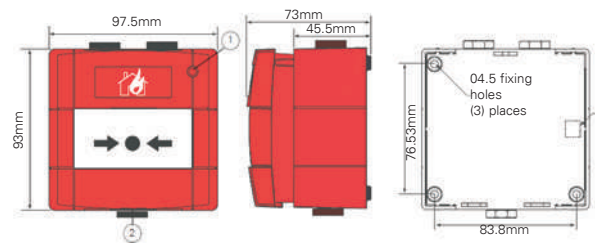

MCP830 Weatherproof Break Glass Callpoint
Overall and Fixing Dimensions
1 – Short Circuit Isolator Activation (Yellow) and Alarm Indicator LED (Red) - MCP versions only
2 – Test/Release Key Access

MCP820M Indoor Callpoint



The MCP820 is an indoor addressable manual callpoint for Fire Panels with MZX technology. It incorporates an integrated line isolator as standard. In case of a short circuit on the loop, the line isolator isolates the affected part of the loop and ensures that the parts of the loop that are not affected from the failure continue to work. The MCP820 is designed for LPCB approvals and is equipped with a programmable status LED.

The MCP820M is an indoor callpoint for Marine applications. All manual callpoints provide high speed communication to the MZX panel of a manual fire alarm.

Technical Information

Approvals:	Meets BS5839 Pt.2 and pr EN54 Pt:11
EMC/RFI:	EN50130-4/EN61000-6-3
Operating Temp:	-10°to +55°C
Relative Humidity:	Up to 95% RH non-condensing
Dimensions:	93H x 89W x 59.5D mm (27.5D mm Flush mount)
Weight:	110g
IP Rating:	24D

Order Codes

514.800.611	MCP820 Indoor Callpoint c/w Isolator
514.800.609	MCP820M Indoor Callpoint c/w Isolator

MCP830M Outdoor Callpoint



The MCP830 is an outdoor addressable manual callpoint for Fire Panels with MZX technology which incorporates an integrated line isolator as standard. In case of a short circuit on the loop, the line isolator isolates the affected part of the loop and ensures that the parts of the loop that are not affected from the failure continue to work. The MCP830 is designed for LPCB approvals and is equipped with a programmable status LED.

The MCP830M is an outdoor callpoint for Marine applications. All manual callpoints provide high speed communication to the MZX panel of a manual fire alarm.





Technical Information

Approvals:	Meets BS5839 Pt.2 and pr EN54 Pt:11
EMC/RFI:	EN50130-4/EN61000-6-3
Operating Temp:	-25° to +70°C
Relative Humidity:	Up to 95% RH non-condensing
Dimensions:	93H x 97.5W x 73D mm
Weight:	240g
IP Rating:	67

Order Codes

514.800.612	MCP830 Outdoor Callpoint c/w Isolator
514.800.610	MCP830M Outdoor Callpoint c/w Isolator

Callpoint Ancillaries

	Description	Order Codes
	Red M141 spacer for red CP200/800 KAC callpoints	90-107
	Callpoint hinged cover for use with MCP callpoints models (Colour Clear)	515.001.128
	Black callpoint bezel for CP200/800 models.	515.001.026
	Test key for all MCP and CP style callpoints	515.001.045

1.56

Addressable MZX Callpoint Ancillaries

Callpoint Back Boxes

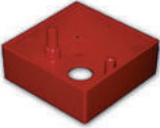
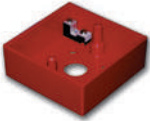
	Description	Order Codes
	Standard Red surface mounting back box for MCP & CP indoor callpoints	515.001.021
	SR2-T Optional Back Box (2 terminals)	10-115

Unless stated the indoor callpoints are supplied as flush mount units. The range is approved for use with the standard backbox. However, SR2-T backboxes are also available.

Callpoint Spare Glasses (Current)

	Description	Order Codes
	EN54 Part 11 Spare Glass for MCP and CP series Callpoints (Pack of 5)	515.001.119

Callpoint & Ancillary Address Labels

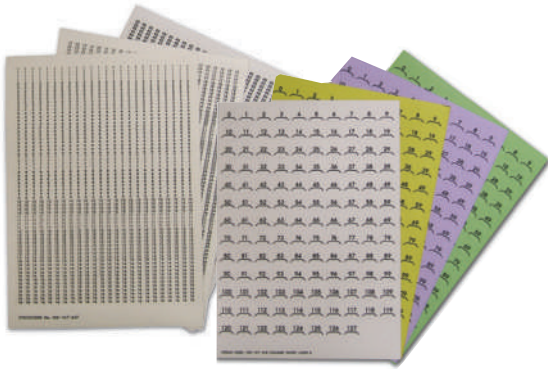

Detectors have a special address flag for carrying the address labels - detailed in the detector section. For other devices or on detectors where zone information is also required a series of address labels are available.

Numbered 1 to 250, the address labels are available in 8 different colours to distinguish between different loops. In addition small zone labels can be fixed to the address labels.

Features

- Colour coded for Easy Loop Identification
- Space for Zonal Label
- Strong Adhesive Backing

Order Codes

Zone Labels

599.047.011	Zone labels - Zones 1 - 16
599.047.012	Zone labels - Zones 17 - 32
599.047.013	Zone labels - Zones 33 - 48
599.047.014	Zone labels - Zones 49 - 64
599.047.015	Zone labels - Zones 65 - 80
599.047.016	Zone labels - Zones 81 - 100
599.047.018	Zone labels - Zones 101 - 120
599.047.019	Zone labels - Zones 121 - 140
599.047.020	Zone labels - Zones 141 - 160
599.047.021	Zone labels - Zones 161 - 180
599.047.022	Zone labels - Zones 181 - 200
599.047.023	Zone labels - Zones 201 - 220
599.047.024	Zone labels - Zones 221 - 240

Address Labels

599.047.030	Address Labels 1 - 250 Loop A - White
599.047.031	Address Labels 1 - 250 Loop B - Yellow
599.047.032	Address Labels 1 - 250 Loop C - Purple
599.047.033	Address Labels 1 - 250 Loop D - Green
599.047.034	Address Labels 1 - 250 Loop E - Grey
599.047.035	Address Labels 1 - 250 Loop F - Blue
599.047.036	Address Labels 1 - 250 Loop G - Orange
599.047.037	Address Labels 1 - 250 Loop H - Red

1.58

Addressable MZX Callpoint Ancillaries

UNIVERSAL STOPPER



Features

- Prevents accidental operation of callpoints
- Strong polycarbonate construction
- Break Seal provided. (Use is optional)

Order Codes

515.001.033	Break Seal Conversion for Old Style STOPPER
STI/BS	Break seals (Pack of 10)

The UNIVERSAL STOPPER provides protection from malicious or accidental activation of manual callpoints. Available for flush or surface mounted callpoints the UNIVERSAL STOPPER is also available with optional high pitch sounder which is activated when the lid is lifted.

A Break Seal is supplied with all models, to provide extra protection if required.

WARNING:- Break Seals should only to be fitted by agreement with relevant fire authorities.

The UNIVERSAL STOPPER is suitable for all callpoints up to 100 mm square.

	Flush	Surface	With Sounder	Weather-proof
STI-13110FR UNIVERSAL STOPPER		✓ 37 mm		✓
STI-13010FR UNIVERSAL STOPPER	✓			✓
STI-13020FR UNIVERSAL STOPPER	✓		✓ 96 dB	✓
STI-13120FR UNIVERSAL STOPPER		✓ 37 mm	✓ 96 dB	✓
STI-1100 STOPPER II			✓ 96 dB	
STI-1130 STOPPER II		✓ 50 mm	✓ 96 dB	
STI-1200 STOPPER II	✓			
STI-1230 STOPPER II		✓ 50 mm		
STI-1230/BS STOPPER II Red Break Seal		✓ 50 mm		
STI-1250 WEATHER STOPPER II	✓			✓
STI-3150 WEATHER STOPPER II		✓ 50 mm		✓
STI-3150/BS WEATHER STOPPER II Red Break Seal		✓ 50 mm		

	Flush Kit	Surface Kit
UNIVERSAL STOPPER	STI-13010FR	STI-13110FR
UNIVERSAL STOPPER with sounder	STI-13020FR	STI-13120FR

	UNIVERSAL STOPPER	STOPPER II
Max. Callpoint size	100 x 100 mm	160 x 160 mm
Max. Callpoint depth	57.5	120
	(add 37 mm surface)	

STOPPER II



The STOPPER II is constructed from tough UV stabilised polycarbonate. Physically larger than the UNIVERSAL STOPPER the STOPPER II extends the number of products to which these tough multi-purpose covers can protect.

It consists of a strong tamper-proof clear polycarbonate cover and frame that fits easily over such products as break glass callpoints.

Features

- Strong polycarbonate construction
- Tamper resistant

Order Code

515.001.034 STOPPER II Surface - Red

STOPPER II can also be fitted with an integral battery powered sounder which activates if the cover is lifted.

The STOPPER II is suitable for callpoints up to 160 mm square.

UNIVERSAL STOPPER & WEATHER STOPPER II



The UNIVERSAL STOPPER and WEATHER STOPPER II extends the life of weather exposed devices, such as break glass callpoints, by offering protection against harsh conditions and environments. Experience has shown that this protective cover can extend the life of products installed in saline atmospheres, such as oil rigs and ship decks.

While offering environmental protection the UNIVERSAL STOPPER and WEATHER STOPPER II are constructed from tough UV stabilised polycarbonate which will also guard against tampering, vandalism or accidental operation of devices such as emergency switches.

Features

- Strong polycarbonate construction
- Provides environmental protection
- Ideal for indoor/outdoor applications

Order Codes

STI-13110FR UNIVERSAL STOPPER Surface Red
515.001.035 WEATHER STOPPER II Red

1.60

Addressable MZX Callpoint Ancillaries

STOPPER II Dimensions

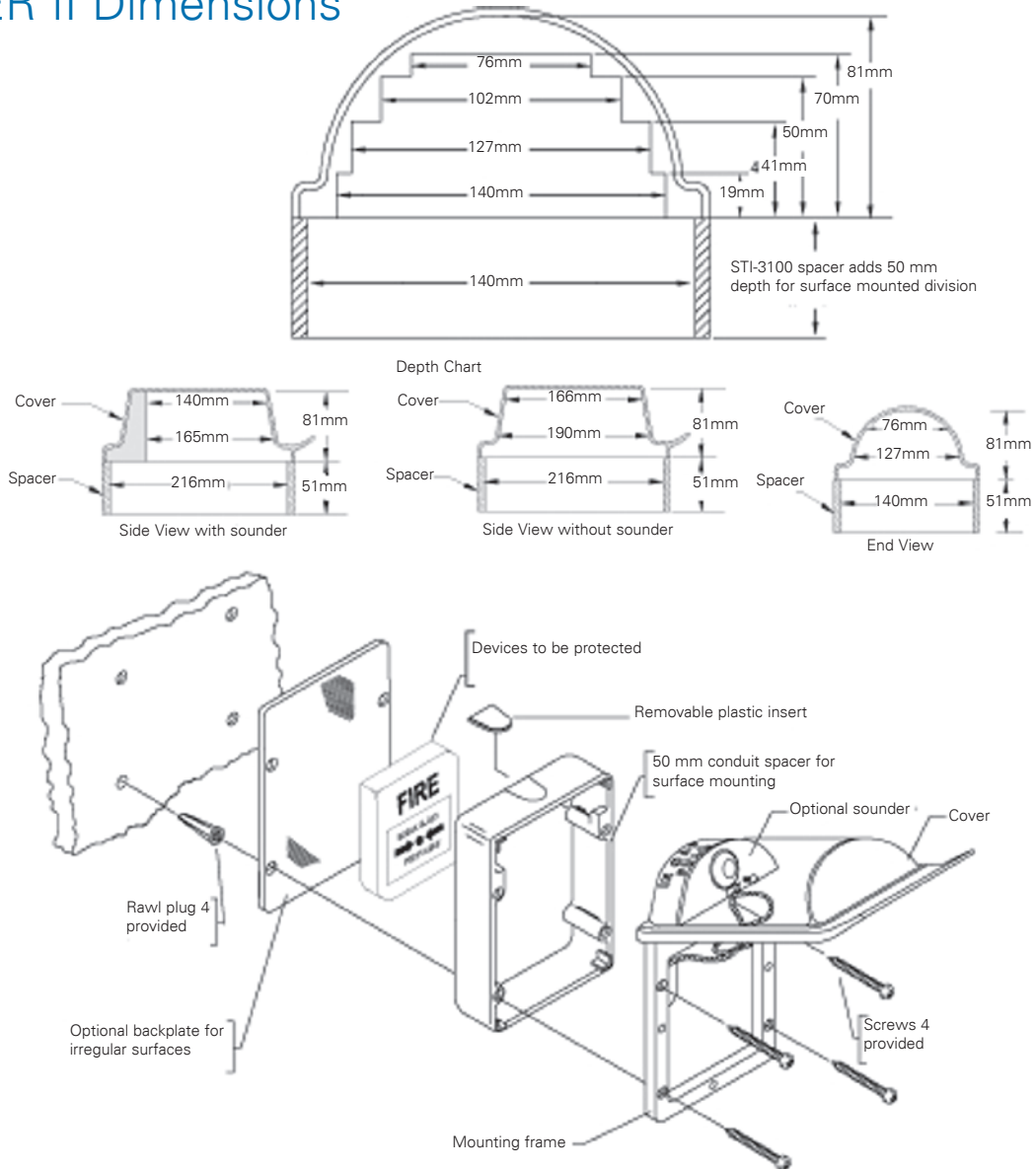

UNIVERSAL STOPPER Dimensions

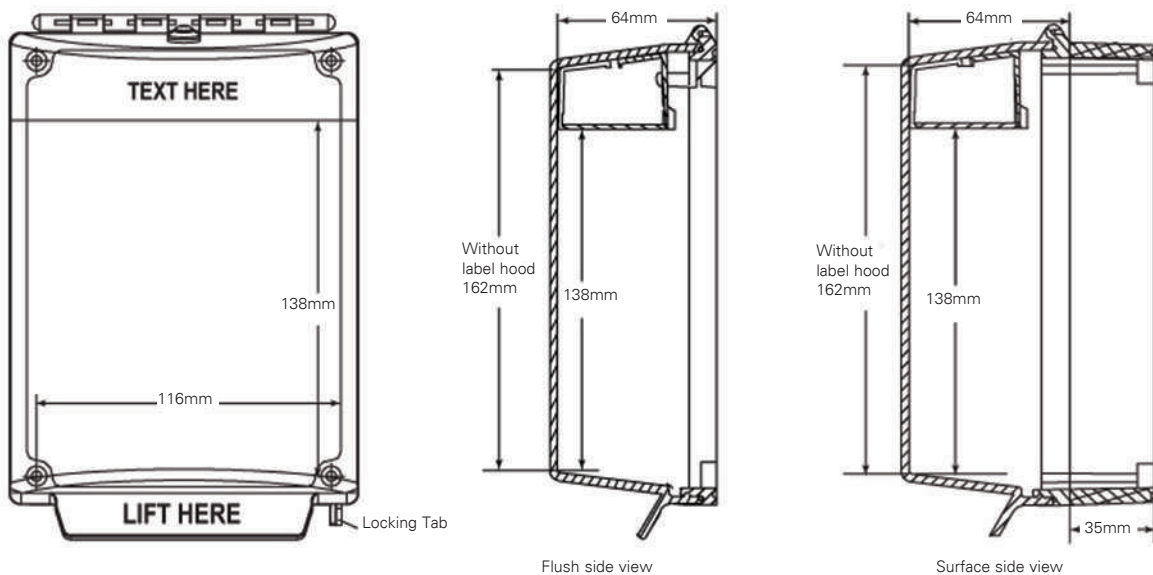

Smoke Beam/CCTV Guard



Technical Information

Dimensions: 260H x 200W x 321D mm

Order Code

516.015.009 STI9625 Smoke beam/CCTV guard

The Smoke Beam/CCTV Guard is manufactured from tough coated steel rod and is designed to protect projected beam detectors or CCTV cameras from vandalism or accidental damage.

Suitable for use with System Sensor, Hochiki and Fireray 2000 detectors.

Breakglass Keybox



Order Code

515.001.043 STI6720 Keybox with printed glass

This tough polycarbonate breakglass keybox is available to protect emergency keys.

1.62

Addressable MZX Software Tools & Accessories

MZX Software Tools & Accessories

MZX Technology Fire controllers are supported by a comprehensive suite of software programmes which provide key features to enable fast and accurate configuration and commissioning of the MZX systems.

MZX Consys

MZX Consys, the highly flexible and extremely powerful programming tool that has been used successfully with MZX systems since day one. Specially designed for MZX it is constantly being extended and refined to meet ever changing demands. Available for free download, the software requires a dongle and license to operate.

Incorporated into MZX Consys is MZX Consys-Express – An alternative approach to system configuration that simplifies the programming effort by automating many of the processes. Its heart lies in a number of pre-defined templates that have been expertly designed to match a selection of building types. The demands on users in terms of experience and training are considerably reduced.

MXDesigner

MXDesigner is a sophisticated engineering design tool that not only ensures system parameters and design rules are obeyed but are key to the ordering and documentation processes. Battery calculations, loop loading calculations, remote bus parameters, system schematics and parts lists are all included. The extensive use of graphics and 'drag and drop' techniques makes the system easy and quick to use. In addition, a design module for the intrinsically safe MZX Digital detectors and associated system 800 components is included. The software is available for free download.

MZX Flow

MZX Flow - If you have ever been involved in the configuration process for a complex 'cause and effect' programme, you will appreciate the benefits of an automated method of documenting your work. MXFlow does just that; it takes your MZX Consys 'event action' and transcribes it into a graphical format that is comprehensive and easy to follow. It can be a valuable commissioning tool that saves time and effort as well as an easily understood form of documentation for future service use.

The software is available for free download to authorised personnel.

MZX Logger

MZX Logger – This software enables the engineer to selectively monitor any device or devices on the addressable loops. The returned values are displayed on a PC screen and can be saved to a file for later analysis. The software is available for free download.

MZX Checker

MZX Checker - This software replaces, in software, all configured MZX loop devices on a single panel. It offers a user the following major functionality:

Connection to a panel directly, or indirectly via the MZX Network (in the same way Consys does to perform a download/upload).

Provides the input status of each and every device configured on the Loops, e.g. make a Sounder go 'No Response', a detector appear active, etc. The ability to display the General Status of each and every Point configured on the Loops, e.g. indicate a Sounder is Isolated, a Callpoint is Disarmed, a Detector is Resetting, etc. The ability to display the Output Status of each and every Point configured on the Loops, e.g. indicate a Sounder is being driven to P1, a Relay Module is not being driven, etc.

MZX Remote

MZX Remote - Remote communications software provides a fast and efficient means of diagnosis without anyone having to leave the office. In situations where access to a site may be difficult or where an attending technician requires high level assistance then MXRemote is the tool for the job. Using modems, MXRemote can link to the MZX Digital fire system via PSTN or IP and once connected, becomes an integral part of the fire system, acting as a fully functional repeater. All system functions are then available to the MXRemote operator. The software is available for free download, but requires a dongle and license to operate.

MZX Service Tool

The MZX Service tool is a powerful and flexible tool for assistance in the installation, commissioning, diagnostics and service of MZX detection systems. The MZX Service tool allows all MZX addressable devices to be interrogated, tested and programmed. Suitable for desktop or single handed operation the MZX Service tool is battery operated using standard rechargeable batteries.

MZX Loop Tester

The MZX Loop Tester can test, commission and fault-find a loop of up to 250 MZX analogue addressable detectors/devices, without a fire panel. A laptop is generally used for operation & display, but a "One Person Installation Mode" is automatically enabled on power up.

Identifies all devices on the loop, determining addresses and types. Over-addressed (>250), unknown device types, and, generally, duplicate addressed devices are recognised.

Monitors analogue values of all detectors/modules on the loop to determine device status: normal/alarm/fault/dirty etc.

MZXConsys Programming Software

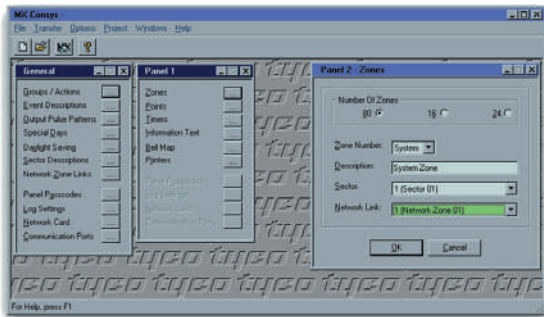

MZXConsys is a powerful Windows programming tool which provides full system programming functions and project configuration and issue control. MZXConsys is used on The MZX & ZX panels.

It also supports automatic data transfer to the TXG graphical mimic and alarm management systems. MZXConsys is available under document control from authorised personnel in the Johnson Controls businesses.

Features

- Programs the system across multiple sub-panels
- Downloads to the system from one point
- Provides Firmware download as well as configuration download
- Dongle protected
- Provides full project configuration printouts.

Order Codes

557.203.003	MZXConsys USB Dongle & License
557.202.118	MZXConsys download lead (PC to FIM)

MZXRemote



MZXRemote is a Windows based software tool for remote service and support of MZX detection panels. MZXRemote provides a full function fire panel repeater running on a PC either locally or over dial up telephone lines or via the internet.

Features

- Facilitates remote diagnostics
- Display identical to panel view
- Remote Assistance

Order Codes

557.203.002	MZXRemote Dongle and license (parallel)
557.203.004	MZXRemote Dongle and license (USB)
557.202.116	MX-FIM Modem Lead
UDS1100	Lantronics Device Server LAN
542.036	TD36

1.64

Addressable MZX Software Tools & Accessories

850EMT Engineering Management Tool



Features

- Simplifies installation and commissioning
- Reduces the possibility of engineer error
- Improves health and safety by removing the need to work at height
- Provides peace of mind through evidence based digital reporting

The engineering management tool communicates with the 850 series and 830 series devices using a 2 way infrared wireless link. Commissioning data is held within the 850EMT and the technician will be prompted to select and confirm configuration details resulting in an evidence based commissioning document that can be downloaded from the programmer.

Technical Information

- 2 way wireless infrared communication with detectors
- TFT colour touch screen display
- Save time with One Visit Commissioning (OVC)
- Facilitates evidence based commissioning
- Read/write the detector/ancillary address
- Display and confirm zone and point strings
- Display temperature/ CO levels / smoke obscuration
- Programme the device LED
- Initiate detector self verification test
- Display detector dirtiness level
- Control ancillary outputs
- Read ancillary statuses
- Compatible with all 800 series devices

Order Codes

- | | |
|-------------|--|
| 516.850.900 | 850EMT engineering management tool |
| 516.800.922 | Spare ancillary programming lead |
| 516.800.924 | Pack of 10 spare pins for ancillary lead |
| 516.800.923 | Accessory kit (Carry case, shoulder strap & car 12v adaptor) |

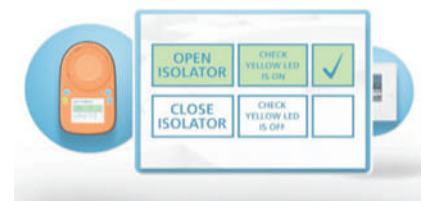
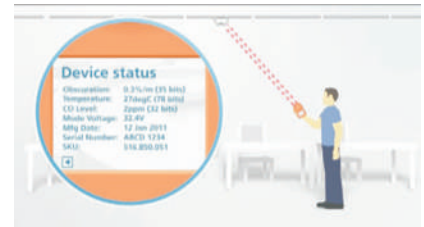
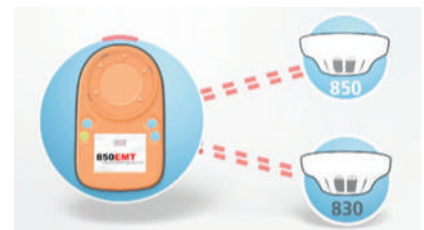

MZX Service Accessory Kit



A carry case which contains the following items:-

- Car Lighter Adapter
- Shoulder Strap

This provides space for the following:

- 850EMT Engineer Management Tool
- Ancillary Programming Lead
- Mains Charger

Features

- Compact
- Organises Tools
- Sturdy Construction Protects Tools

Order Code

516.800.923

850EMT Engineer Management Tool accessory kit

MZX AVR Programmer



This unit will allow the MZX Technology® Fire Controller Loop Drivers to be updated to the latest software version. When required upgrades can be performed easily and quickly in the field with minimal system downtime. The MZX AVR Programmer is designed for use with MX, MZX, ZX and T2000 addressable fire controllers, please check document 17-05-AVR for compatibility details.

Features

- Pre-Programmed with latest AVR firmware
- Powered from XLM Loop card or FIM, No external power required
- Simple to operate
- Compact handheld device
- Complete with ribbon cable and connector
- High Speed USB port
- Increased RAM increases speed of operation

Technical Information

User Interface:	2 Button Keypad
LEDs:	3 Status LEDs
Operating Temp:	0°C to 50°C
Dimensions:	189H x 80W x 31D mm

Order Code

516.800.942

AVR PROGRAMMER EPSILON5-MK4

1.66

Addressable MZX Service & Spares

MZX Service & Spares

Keys & Keyswitches

557.203.005	Set of spare keys for MX Panel (AL102)
557.180.209	Keyswitch assembly for use with MX2 controllers (spare)
557.201.508	MZX Spare Key Set
1500080	MZX Keyswitch cylinder
1700421	MZX Keyswitch lead

Housings & Metalwork

557.201.300	BFP801 Blank Half Module - Grey Overlay
557.201.306	Standard MX Expansion backbox and chassis plate

CPU FIMs & Loop Cards

557.202.000	FIM801 1-Loop Field I/F Module
557.202.001	FIM802 2-Loop Field I/F Module
557.202.008	FIM801CV – T2000CV only
557.202.007	XLM800 2-Loop Expansion Card
557.202.810	CPU801 Central Processor Unit

Power Supplies

557.202.210	PSU830 Power Supply with Loop Booster
557.202.050	PSM800 Temp Sensor Accessory Kit
557.202.113	PSB to FIM Cable
557.202.608	PMM800 Power monitor module
557.202.609	BAQ60T24 2.5A MZX PSU
557.202.610	BAQ140T24 5A MZX PSU
557.202.611	PMM805 Power Monitor Module - 5 V Repeater
557.202.612	PMM840 Power Monitor Module - 40 V Loop Power

Indication & Expansion

557.202.013	OCM800 Operator Control Module
557.202.019	ODM800 Operator Display Module
557.202.021	ANN840 40-Way Alarm/Fault LED Module
557.202.022	ANN880 80-Way Alarm LED Module
557.202.020	COM820 20-Way Status/Command Module
557.202.200	DCM800 MX2 Display Control Module (without LCD assy)
557.202.601	DCM816 16 zone display PCB for MZX125/MZX16R
557.202.602	DCM832 32 zone display PCB for MZX250/251/252
557.202.209	MX2 LCD assembly
557.202.028	RSM800 Power Supply
557.180.053	Isolated RS485 IC (for U16)
557.180.052	Serial Printer Driver Kit
557.202.613	DCM864R Spare Display / Control PCB for MZX 253 (64 red zonal LEDs)
557.202.614	DCM8240 240 zone display PCB for MZX254 and MZXDR

Callpoint Key & Glasses

515.001.045	MCP test key
515.001.119	MCP EN54 Spare Glasses pk of 5

MX Service Tool

516.800.922	MZX Service tool, Spare programming lead
516.800.924	MZX Service tool, Spare pins for programming lead pk of 10



Conventional Systems

Panels

Detectors

Detector Bases

Callpoints & Ancillaries

2.02

Conventional Systems

Conventional Systems

Whilst acknowledging the benefits of addressable systems technology, there still remains a place for conventional fire alarm and detection systems. Conventional systems can be installed using both two and four wire devices, that is with sounder and beacon devices on the same circuits as detectors and call points (2 wire) or on separate circuits (4 wire). The obvious advantage of the two wire system is a saving in the cost of cable and labour. Conventional systems are suitable for the smaller and simpler systems where the functionality of addressable systems is not required, such as small shops, schools, and small industrial units and similar.

Control Panels

The MZX range of conventional panels supports “twin wire” systems up to eight zones and four wire systems from four to thirty two zones thereby providing a panel to suit a wide range of types and sizes of buildings. Both “twin wire” and four wire systems support simple class-change for use in schools, and two stage alarm outputs where phased evacuation is a requirement. Repeater panel options are available with both systems as are a comprehensive range of detectors, call points and sounders and beacons.

Detectors

The MZX range of Conventional detectors, although not as intelligent as their addressable namesakes, employs similar excellent detection and anti-false alarm features. The range includes Multisensors, optical/heat and carbon monoxide/heat, in addition to single channel optical smoke, rate of rise and fixed temperature heat, ionisation chamber and infra-red flame detectors. All detectors within this range can be fitted to a standard or sounder base or a diode continuity base. The detector range is further enhanced by a range of detector ancillaries including, false ceiling mounting adaptor, conduit mounting adaptor, waterproof mounting adaptor, protective cage and remote led indicator allowing installation into a variety of areas and conditions.

Callpoints

The MCP range of call-points includes both indoor and outdoor models. Call points can be flush or surface mounted as a selection of back boxes and bezels are available. Anti-tamper devices are also available which fit around the unit making it less likely for persons to attempt malicious activations. The call point activation window can be a non-fragmenting element which breaks cleanly with no glass fragmentation, but needs replacing after use; or a deformable element which can be reset with a key and does not need replacing. All models have an integral alarm led. In addition to that, the range includes manual DIN call points for inside and outside use.

MZX-c+ Conventional Panel



The MZX-c+ range of Conventional Control Panels are designed to be both installer and user friendly. They are designed and manufactured to a high standard and are approved by LPCB to EN54 parts 2 & 4.

These Panels are available in 4,8,16 & 32 zone versions along with suitable Repeaters for all models.

The 8 to 32 Zone Panels are capable of driving any combination of 8 channel output expansion boards (relays, alarm circuits & open collector 0v outputs) up to a maximum of 12 boards which can be set to zonal activated or common output modes.

Each Panel has extensive configuration options but remains easy to install, program and operate and are supported by detailed documentation on commissioning, operation and maintenance.

The Panels are designed to work with a wide range of manufacturers detectors (in addition to Tyco detectors) and are suitable for use in many types of installation including upgrades and new installations.

Ancillaries and Expansion

- C1631 Repeater Interface Board provides a port for driving up to 5 repeater panels. One C1631 Repeater interface board is required for the panel and one for each repeater. Repeaters are supplied with a C1631 fitted.
- C1630 Output Expansion Interface Board provides a port for driving up to 12 output expansion boards.
- EXP 4 and EXP 4 PSU Expansion Housings are designed to house any combination of up to four output expansion boards. The PSU version is equipped with a 5 A 24 Vdc power supply with space for 2 x 12 V 12 Ah batteries. Housing dimensions 325W x 370H x 126D mm.
- EXP 5 and EXP 5 PSU Expansion Housings are similar to the EXP 4 and EXP 4 PSU but accommodate five output expansion boards. Housing dimensions 400W x 441H x 131D mm.

Features

- 4, 8, 16 and 32 zone versions available
- Semi-Flush mounting using optional bezel
- Supports the complete range of EN54 Approved Series 600 Detectors including photo multi-sensor and CO multi-sensor
- Compatible with System 620 ATEX and IECEx approved intrinsically safe system
- Extensive custom options programmable via switches and front panel controls
- Two stage alarms and investigate delay options
- Day/Night modes and alarm counter (with optional timer module)
- Full EN54 zone operation with options for non-latching, short circuit alarm or indication only circuits

Additional Benefits

- Inputs for remote Silence, Evacuate, Reset and Class change
- Configurable monitored or volt free outputs for Fire, Fault and Protection
- Outputs for zones 1 to 4 (open collector) with 8, 16 or 32 zonal outputs provided by optional expansion boards
- Outputs for Disablement active, Evacuate active and buzzer active (open collector)
- Volt free reset relay. Active for 10 seconds following a panel reset
- 8 to 32 zone systems can drive up to 12 expansion input / output modules per panel
- Drive up to 5 repeater panels

2.04

Conventional Panels

Technical Information

	Panels				Repeaters		
	2 Zone	8 Zone	16 Zone	32 Zone	8 Zone	16 Zone	32 Zone
Electrical							
Mains Supply	230 Vac +10% - 15%						
Power Consumption	85 W	165 W	165 W	240 W	85 W	85 W	85 W
PSU / Charger Output	1.5 A	3.0 A	3.0 A	5.0 A	1.5 A	1.5 A	1.5 A
Sounder Circuits 24 Vdc nominal	4 @ 500 mA	4 @ 1 A	4 @ 1 A	4 @ 1 A	N/A	N/A	N/A
Aux. DC Output 24 Vdc nominal	500 mA	1 A	1 A	1 A	N/A	N/A	N/A
Maximum Battery Space	2 x 3 Ah	2 x 7 Ah	2 x 12Ah	2 x 17 Ah	2 x 3 Ah	2 x 3 Ah	2 x 3 Ah
Environmental							
Operating Temperature	-5 to +40°C						
Operating Humidity	5% to 95% non-condensing						
Mechanical							
Dimensions (WxHxD mm)	25 x 370 x 126			400 x 441 x 13	325 x 370 x 126	400 x 441 x 13	
Space for 8 way expansion	N/A	2 Boards	2 Boards	se Exp Hsg	N/A		
Weight Excl. Batteries Kg	6.2	7.1	7.1	10.25	6.2	6.2	7.6
Enclosure Colour	RAL7035 Light Grey						

Order Codes

508.032.002.EA	MZXC+ 4 Zone Panel English/Arabic
508.032.003.EA	MZXC+ 8 Zone Panel English/Arabic
508.032.004.EA	MZXC+ 16 Zone Panel English/Arabic
508.032.005.EA	MZXC+ 32 Zone Panel English/Arabic
508.032.006.EA	MZXC+ 8 Zone Repeater 240 Vac English/Arabic
508.032.007.EA	MZXC+16 Zone Repeater 240 Vac English/Arabic
508.032.008.EA	MZXC+ 32 Zone Repeater 240 Vac English/Arabic
508.032.012	MZXC+ 4 Way Expansion Housing
508.032.013	MZXC+ 4 Way Expansion Housing with PSU
508.032.014	MZXC+ 5 Way Expansion Housing
508.032.015	MZXC+ 5 Way Expansion Housing with PSU
557.201.502	Flush Mount Bezel for MZXC+ 4/8/16 Zone Panel and Repeater
2605060	C1630 O/P Expansion Interface Board
2605061	C1631 Repeater Interface Board
2605062	C1632 16 Zone Interface Board
2605063	C1633 LED Driver Board
2605064	C1634 Relay Output Board
2605065	C1635 Monitored Output Board
2605070	C1651 MZX-c+ Timer Board

T1200 Conventional Marine Controller



Features

- Developed for use in vessels which require between 4 and 32 zones of fire detection.
- Console or bulkhead mountable
- Range includes a separate Water Mist Panel
- Integrated Voyage Data Recorder output on 16 and 32 Zone Panel
- Increased configuration options to meet a wide range of Class Society requirements
- Discrimination between Automatic Fire Detectors and Manual Alarm
- Optional Marine Approved Muster Alarm.
- Separate battery box
- Multiple power supply options
- Lloyds approved water-mist functionality

Detection Options

- **Optical Detector** - An excellent all round detector suited to all applications.
- **High Performance Optical (HPO) Detector** - A direct replacement for the Ion Chamber Smoke Detector.
- **Flame Detector** - Used where there is a risk of large flaming fires e.g. Machinery Spaces.
- **Enhanced Compensated Carbon Monoxide (CCO) Detector** - The best detector for early warning without false alarms used in life threatening applications e.g. Cabins, Public Spaces etc.
- **Heat Detector** - Used where smoke detectors cannot be used e.g. Galleys, Laundries, Drying Rooms etc.
- Extensive configuration options using simple on board DIL switches and links.

Developed and Manufactured in the United Kingdom the T1200 range of Conventional Panels are a powerful yet user friendly series of Control Panels. The range is fully approved by all major Marine Authorities and takes advantage of the very latest technological advancements both in terms of design and manufacturing to the latest Marine standards.

Configurable Detection Zones allow zones to be configured for any or all of the following:

- Latching or Non Latching Fire Indication Normal or Intrinsically Safe Zone
- Monitoring of Machinery space zones.

Crew Alert Mode:

- Manages Alarm Annunciation. Pre-configured for Immediate use.

2.06

Conventional Marine Panels

Order Codes

Control Panels, Repeaters and Ancillaries

508.023.001	T1204 DC 4 Zone Panel C/W 1.5A 24Vdc PSU (requires T1200B battery box)
508.023.002	T1204A1 4 Zone Panel C/W 1.5A 110Vac PSU (requires T1200B battery box)
508.023.003	T1204A2 4 Zone Panel C/W 1.5A 230Vac PSU (requires T1200B battery box)
508.023.104	T1216-C console-mount 16 Zone Panel C/W 5A 115/230Vac PSU
508.023.105	T1216W-C console-mount 16 Zone Watermist Panel C/W 5A 115/230Vac PSU
508.023.106	T1232-C console-mount 32 Zone Panel C/W 5.0 AMP 115/230Vac PSU
508.023.111	T1216R-C console-mount 16 Zone Repeater without PSU
508.023.114	T1232R-C console-mount 32 Zone Repeater without PSU
508.023.122	T1200E-C console-mount expansion box without PSU
508.023.123	T1200B-C battery box suitable for 2 X 17A/H SLA batteries
508.023.126	AC2SW 230 Vac mains changeover unit
508.023.127	AC1SW 115 Vac mains changeover unit
2605061	C1631 Repeater Interface Board
2605063	C1633 LED Driver Board
2605064	C1634 Relay Output Board
2605065	C1635 Monitored Output Board
508.023.035	C1665 Muster Interface Board
508.023.036	A1466 Relay Output Board

Spares

509.023.001	C1626 4 Zone Panel Motherboard C/W AC PSU
509.023.002	C1626 4 Zone Panel Motherboard without AC PSU
509.023.008	T1216-C Motherboard
509.023.009	T1232-C Motherboard
509.023.010	T1216W-C Motherboard
509.023.011	C1626 Repeater Motherboard C/W AC PSU
509.023.022	C1628 16 Zone Panel Display
509.023.023	C1629 32 Zone Panel Display
509.023.031	C1628 16 Zone Repeater Display
509.023.032	C1629 32 Zone Repeater Display
2605060	C1630 Output Expansion Interface Board
509.023.042	C1632 16 Zone Panel Expansion Board
509.023.051	PS136 5.0 A 110/230Vac PSU
509.023.052	PS40 1.5 A 2 4Vdc PSU
509.023.061	T1200 & T1200-C Spare Key Set
509.023.071	C1714 T1200-C Serial VDR PCB

MZX-e Extinguishing Control Panel



The MZX-e extinguishing control panel is powerful yet user-friendly and is designed and manufactured to a high standard. The panel features approval to BS EN 12094-1:2003, BS EN 54-2 and 4 and is designed to BS 7273 part 1. The panel has extensive configuration options but is easy to install, programme and operate. The removable chassis enables the engineer to “first fix” an empty cabinet and then fit the chassis at the commissioning stage. There is a comprehensive range of accessories available to meet most customer requirements.

Operation

Three fully-monitored detection zones are provided. Zones 1 and 2 normally provide first stage and second stage fire conditions to allow extinguishant discharge (coincidence detection zones). Zone 3 is an auxiliary zone for detection only purposes. Zone 4 is used as a manual release zone.

Facilities

Three fully-monitored alarm circuits are provided, each rated at 0.5A with various configuration options via the engineers DIL switch settings. Two circuits are designed to provide audible warning of any fire condition and one circuit to provide an individually distinct audible warning of the pre-discharge, discharged and emergency hold condition. Two fully-monitored actuator/solenoid circuits, each rated at 1A, operate simultaneously upon “extinguishant release.” An RS485 multi-drop circuit link supports up to 7 Status Controller/Indicators of any type mixed on the communication path. Additional terminals and configuration options allows the engineer to configure the manual release, abort and hold switches to either data comms or hard wired inputs as required.

Normally-open inputs provide for remote evacuate, silence alarms, system reset, lock-off input, low pressure and gas discharged pressure switch input.

Outputs are provided for first stage signalling, second stage signalling, system discharged, common fire and common fault. These outputs may be configured as either Volt-Free C/O contacts or monitored 24 V (50 mA) outputs. A system reset Volt-Free relay is also provided.

Features

- Approval to BS EN 12094-1:2003 additional options
- Approval to BS EN 54-2 and 4
- Designed to BS7273-1:2000
- Comprehensive gaseous extinguishing system support
- Monitored inputs for gas discharged, gas low, isolation valve closed/abnormal, gas trapped in manifold
- Control inputs for auto/manual, gas hold, gas abort
- 1 minute actuator cut off option
- Monitored actuator/solenoid release
- Extensive disablement options
- Common fire, fault, relay / monitored output facilities
- 1st, 2nd, 3rd stage and gas discharged relay / monitored output facilities
- Reset relay facilities

Configuration

The use of DIL switches on the internal motherboard enables the engineer to easily configure the extensive options available and view the panel’s configuration upon any return visit.

Additional Benefits

- Intrinsically safe barrier settings
- Metron or solenoid compatible
- Single or double knock operation
- Pre-discharge delay adjustable from 0 to 60 seconds
- Discharged indication with or without pressure switch
- Inhibit silence alarms until gas discharged
- Latching or non latching fault indication option
- Option for rapid buzzer pulse when gas discharge is imminent
- One man zone and sounder test
- Easily removable chassis

Order Codes

- | | |
|----------------|--|
| 508.033.050.EA | MZX-e Extinguishing Control Panel English / Arabic |
| 508.033.002.EA | MZX-e SLU1 Status Lamp Unit, Indication only English / Arabic |
| 508.033.003.EA | MZX-e SLU2 Status Lamp Unit, Indication, Auto/Manual Select and Manual Release English / Arabic |
| 508.033.004.EA | MZX-e SLU3 Full Function Status Lamp Unit, Indication, Auto/Manual Select, Manual Release, Hold, Abort & Time Counter English / Arabic |
| 508.033.005.EA | MZX-e SLU4 Weatherproof Status Lamp Unit, Indication and Auto/Manual Select English / Arabic |

2.08

Conventional Extinguishing Panel Ancillaries

Extinguishing Door Interlock Ancillaries & T500 Series Spares



Order Codes

- 527.001.028 Micro-switch Lock Keep & Back-plate For Deadlock
- 599.001.012 Lamp 28 V 60 mA Used On T525

A microswitch lock keep can be used with a deadlock to provide a signal to the panel to ensure that the extinguishing system is only put into Automatic mode when the door is locked shut.

Releasing Callpoints



Order Codes

- 540.007.001 E1 Single Red lamp unit Heavy Duty IP67 Cast Aluminium Surface Mount Lamp Unit
- 509.030.113 Extinguishant release indoor
- 509.030.114 Extinguishant release outdoor
- 509.030.115 Extinguishant abort indoor
- 509.030.116 Extinguishant abort outdoor

A range of Call Points that can be used as part of a system to efficiently manage the release of any extinguishing gas in accordance with EN12094-3:2003.

Designed for indoor (IP24D) and outdoor (IP67) applications. Multilanguage function marking labels English, Spanish and Portuguese.

Weatherproof Extinguishing Indicator Units



Order Code

- 509.030.117 T561 Extinguishing Release Manual Callpoint

E1 Single Red lamp unit Single 24 Vdc red lamp labelled 'Extinguishing System Operated'

Technical Specification Dimensions:

	H (mm)	W (mm)	D (mm)
E1	110	110	122
E3	220	91	115

Weatherproof Extinguishing Indicator Units



Order Code

540.007.002 E3 Red/Amber/Green lamp unit

Heavy Duty IP67 Cast Aluminium Surface Mount Lamp Unit
Three 24 Vdc lamps:

Red labelled 'Extinguishing System Operated'
Amber labelled 'Extinguishing System Automatic Control'
Green labelled 'Extinguishing System Manual Control'

2.10

Conventional Panel Ancillaries

DDA Compliant Pager - Fire Tek Pro Paging System



The FireTek Pro paging system is designed for use with Fire Systems installed in commercial, industrial and educational premises. The system is designed to alert the "hearing impaired" in the event of a fire or other emergency where an audible sounder is the normal means of indication. The FireTek Pro has been designed to comply with BS5839-1: 2002 in regard to alerting the "hearing impaired" to the activation of a fire alarm. The system can be used in conjunction with a security panel to alert guards who may be located remotely.

The interface to the fire panel comprises of three Prioritised Fire Inputs and two Fault Inputs. A monitored cable assembly is provided with each system which includes a "common fault" relay output back to the host fire panel. This output will activate if the FireTek Pro suffers a mains failure, transmitter fault, antenna mismatch, interface link failure, or low battery state.

Upon activation of any one of the Fire Inputs, the unit will enter the fire alert condition, prioritising and transmitting the Fire message to all enrolled pagers. The transmissions will be repeated until the fire condition is reset. The pagers ensure that users are alerted by distinct vibration patterns and clear text messages.

UHF Radio Operation

The unit utilises UHF radio frequencies, the main benefits being superior in-building radio signal propagation and the option of a manual frequency co-ordinate license issued by OFCOM. Licensing the FireTek Pro provides a higher degree of protection from interference. This fact is acknowledged in Section 18.1 of BS 5839-1:2002.

High Integrity Pagers

The pagers have added features specifically incorporated for the hard of hearing when used with the FireTek Pro. These include distinct vibrate alerts for emergency messages, a vibrating out of range indicator which displays a "No Service" message when the radio link is lost, and a vibrating low battery indicator.

Antenna Options

Mini Dipole - remote internally mounted antenna

Folded Dipole - remote externally mounted antenna

Features

- UHF radio link for maximum licensable protection
- Unique coding avoids neighbouring system clashes
- Self monitoring of system health
- Rugged steel enclosure to IP65
- Backlit 2 line text display continuously reports system status
- Additional audible & visible status indicators
- Prioritised Fire Alarm Inputs
- Automated test calls alert pagers to loss of radio signal
- Fault Notification to the lost fire panel via a monitored link
- Key operated "System Test" facility for routine confidence checking
- Over 90 hour's backup operation with internal battery
- Achieves Disability Discrimination Act (DDA) compliance

Technical Information

Supply Voltage:	230 V AC 50-60 Hz 12 v 7Ah standby battery
Operational Current:	250 mA
Inputs:	3 Prioritised Volt Free (Fire) Input 1 - Fire Alarm - Evacuate Building Input 2 - There is an Incident - Leave Building Input 3 - Prepare to Evacuate - Await Instructions 2 Volt Free (Fault)
Outputs:	1 off volt free relay output
Fault Notification:	Mains Failure Transmitter Fault Antenna Mismatch Panel Link Failure Low/Missing Battery
Visual Display:	2 Line Backlit LCD
Enclosure:	Steel Enclosure rated to IP65
Dimensions:	380 x 320 x 110 mm (HxWxD) (No antenna fitted)

Order Codes

557.200.071	Paging Transmitter
557.200.074	40 Character Alpha Numeric Pager
557.200.076	1/2 wave dipole antenna
557.200.077	Wall mounting folded dipole antenna
557.200.078	Pole mounting folded dipole antenna
557.200.079	5 metre antenna feeder cable
557.200.080	10 metre antenna feeder cable

Point Detectors



Through innovative design the Series 600 detectors have reduced the installation and servicing time to a minimum, needing only one visit to complete the installation and having a park position for the detector to ease the servicing.

The Series 600 detectors include the unique enhanced Carbon Monoxide CO fire detector, which provides a general purpose fire detector with unprecedented early detection capability and excellent false alarm immunity. The CO fire detectors are the first choice for sleeping risks.

Also included within the range is the intelligent high performance optical smoke (HPO) detector. The use of the patented optical sensing chamber, together with refined signal processing, has enabled the introduction of a smoke detector suitable for fast, reliable smoke detection of both slow and fast developing fires.

Features

- Unique early detection enhanced CO fire detector
- Intelligent Universal HPO Smoke Detector
- Low profile, discreet and unobtrusive
- Superior performance and reliability
- Designed for fast, easy installation
- Integral and remote alarm LED
- Series of Product Approvals

The HPO can be seen as a truly universal smoke detector, suitable for most applications.

Approvals:



2.12

Conventional Detectors

601PH / 601PH-M Heat + Optical Smoke



These high performance detectors react to the whole range of fire products from slow smouldering fires, producing visible particles to open flaming fires producing large numbers of very hot smaller sized aerosols. It combines optical and heat detector technology to detect clear burning fire products which hitherto could only be easily detected by ion-chamber detectors. For normal ambient conditions, the high performance optical detector behaves as a normal optical detector.

Order Codes

516.600.002	Approval LPCB	Model 601PH	
516.600.202	Approval Marine	Branded Tyco	Model 601PH-M

Only when a rapid rise in temperature is detected does the sensitivity of the detector increase and the presence of smoke will confirm a fire condition. The HPO will not operate on a rate of rise of temperature alone.

601CH Enhanced Carbon Monoxide Fire



The CO fire detector is a unique general purpose fire detector which provides very early warning of slow smouldering fires. Ideal for sleeping risks the CO fire detector is also well suited to many applications where heat detection is insufficient but smoke detection causes false alarms. As CO travels more freely than smoke the position of CO fire detectors is more flexible.

Order Code

516.600.004	Approval LPCB	Model 601CH
-------------	------------------	----------------

This feature is particularly useful in large complex structures such as atria and warehouses, where position of smoke detectors is difficult.

601P / 601P-M Optical Smoke



These detectors are capable of detecting the visible smoke produced by materials which smoulder or burn slowly, i.e. soft furnishings, plastic foam etc.; or 'smoke' produced by overheated but unburnt PVC. These detectors are particularly suitable for general applications and areas where cable overheating may occur e.g. electrical services areas. The novel design of the asymmetrical sampling chamber and signal processing techniques stop unwanted alarms caused by very small insects. i.e. thrips.

Order Codes

516.600.001	Approval LPCB	Model 601P	Model 601P-M
516.600.201	Approval Marine	Branded Tyco	

Smoke entering the sampling chamber scatters the infra-red light pulses onto a photo-diode. These pulses are converted to an electrical signal which is compared against a preset alarm level.

601H-R / 601H-R-M / 611H-F / 631H-F Heat



These detectors are capable of detecting the visible smoke produced by materials which smoulder or burn slowly, i.e. soft furnishings, plastic foam etc.; or 'smoke' produced by overheated but unburnt PVC. These detectors are particularly suitable for general applications and areas where cable overheating may occur e.g. electrical services areas. The novel design of the asymmetrical sampling chamber and signal processing techniques stop unwanted alarms caused by very small insects, i.e. thrips. Smoke entering the sampling chamber scatters the infra-red light pulses onto a photo-diode. These pulses are converted to an electrical signal which is compared against a preset alarm level.

Order Codes

Rate-Of-Rise

516.600.003	Approval LPCB	Model 601H-R	
516.600.203	Approval Marine	Branded Tyco	Model 601H-R-M

Fixed Temperature 60°C

516.600.214	Approval LPCB/Marine	Model 611H-F
-------------	-------------------------	-----------------

Fixed Temperature 90°C

516.600.033	Approval LPCB/Marine	Model 631H-F
-------------	-------------------------	-----------------

601F / 601F-M Solar Blind IR Flame Detector



Order Codes

516.600.006	601F
516.600.007	601F-M Marine

Flame detectors, unlike smoke and heat detectors, do not rely on convection to transport the fire product to the detector, nor do they rely on a ceiling to trap the products. They can therefore, be used to protect large open areas without sacrificing speed of response to flaming fires. In order to ensure full coverage, however, flame detectors do require direct line of sight to all parts of the protected area.

Infra-red flame detectors such as the 601F are designed to respond rapidly to fires which involve cleanburning fuels such as alcohol or methane, ie fires which would not be detected by smoke detectors. The 601F Flame detector, by virtue of it's operating wavelength and flicker discrimination, is insensitive to normal environmental influences. For outdoor use, a solar-blind detector (e.g. the S200Plus) should be used.

The 601F flame detector should, normally, only be used inside buildings to supplement heat and smoke detectors.

2.14

Conventional Detectors

Series 600 Detector Specifications

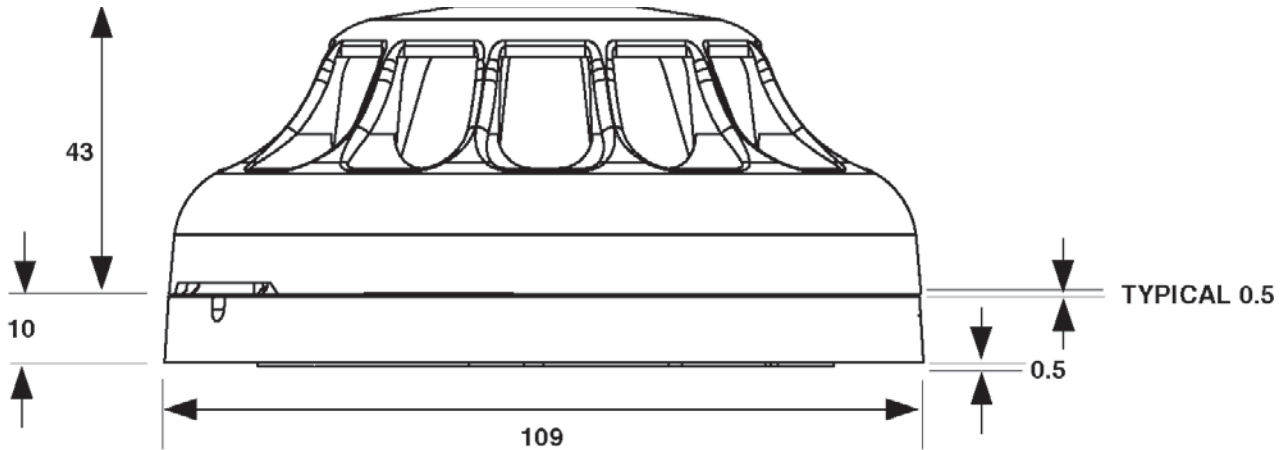

	601I	601PH/P/ 601PH-/ 601P-M	601H-R/611H-F/ 601H-R-M/631H-F	601CH/ 601CH-M	601F/ 601F-M
Weight	100 g	93 g	80 g	90 g	74 g
Material	FR 110 Bayblend				
Operating Temp.	-20 to +70°C	-20 to +70°C	-20 to +70°C*	-10 to +55°C	-20 to +70°C
Storage Temp.	-40 to +80°C	-25 to +80°C	-25 to +80°C	-20 to +55°C	-40 to + 80°C
Relative Humidity	95/98% Non-Condensing				
Quiescent Current(typ)	62µA	65µA	61/65µA	87µA	300µA
Alarm Current(typ)	54 mA	45 mA	53 mA	53 mA	42 mA
Operating Voltage	10.5 - 33 Vdc	10.5 - 33 Vdc	10.5 - 33 Vdc	10.5 - 33 Vdc	18-28Vdc
*Short Term (<3min) -40 to +120°C					

Solar Blind Infra Red Flame Detector Dimensions



T54B Point Type Heat Detector



Constructed from stainless steel, the T54B is an extremely rugged heat detector that can be used to detect fires in the harshest of environments. The T54B can be used in environments with ambient temperatures up to 200°C and, being hermetically sealed is impervious to most contaminants.

Classified as a simple device, the T54B can be used in Zone 0 areas when connected to a suitable intrinsically safe barrier.

For reliable operation, it is recommended that T54B detectors have set points 20°C or 20% (whichever is higher) above the maximum temperature they will be exposed to in normal operation.

Preferred factory preset temperatures are 60, 90, 100, 145°C; normally with open contacts.

Note: This device is not EN54 approved.

Features

- Sealed Stainless Steel Construction
- Suitable for use in hazardous areas

Technical Information

Operating voltage @	
0.5 A:	240 Vac to 24 Vdc
Switching Current:	5 to 500 mA
Contact Resistance:	<1 ohm
Actuating Temp:	Factory set to 60 - 240°C Fixed Temp only: Type E
Accuracy:	+ or - 5%
Ambient Temp:	-40 to +270°C
Relative Humidity:	100% RH
Protection Category:	IP67
Thread Size:	M20 x 1.5 mm

Order Codes

516.033.011	T4E60X T54B Point Type heat detector - 60°C
516.033.012	T4E90X T54B Point Type heat detector - 90°C
516.033.013	T4E100X T54B Point Type heat detector - 100°C
516.033.014	T4E145X T54B Point Type heat detector - 145°C

Other temperatures and normally closed contacts are available by request.

2.16

Conventional Detector Bases

Conventional Detector Bases & Ancillaries



The 600 Series range of low profile detectors provide a comprehensive range of highly effective and aesthetically pleasing smoke and heat detectors with worldwide approvals.

The unique design and leading edge technology of the detectors go beyond the detection technology itself. The range of detector bases is designed to make low profile detector installations cost effective, aesthetically pleasing and easy to install and maintain – thus minimising disruption.

The detector bases include standard universal bases, which have no integral electronics, thus making them low cost and low maintenance. Alternatively, a range of functional bases incorporate sounders and relays to provide a cost effective method of adding functions and flexibility to the fire detection installation.

Features

- Optional relay bases
- Remote indication LEDs
- Optional conduit entry backboxes
- Protective wire cages

Detector Bases take two forms:

- **Standard Detector Bases**
- **Functional Detector Bases**

Standard universal detector bases are compatible with the Series 600 low profile detectors. The standard bases have no electronics and even when the detectors are connected to the bases, they can be electrically disconnected and left in a 'park' position. This enables wiring integrity tests to take place without any damage to electronics. An optional, tool removable locking pin allows the detector to be fixed in place to prevent tampering.

Functional detector bases use a common moulding which incorporates a double sided circuit board which enables electrical connections to be made on the top and bottom of the functional base. This allows the functional bases to be retrofitted into new and existing universal bases or alternatively the depth and cost of the installed detector can be reduced by using the functional base instead of the universal base. This feature enables additional sounders to be easily added during commissioning. In addition, changes to the building during it's life can be easily adapted to, by retrofitting sounders and relay outputs to existing detection points. When functional bases are fitted to universal bases, they automatically lock into position. Removal is then achieved using the detector removal tool. This feature ensures that the detector and functional bases are removed separately.

Standard Detector Bases

4B 4" Detector Base



The new 4B 4" detector base is designed to snap-fit to the ceiling tile adaptor or it can be screw fixed to a ceiling in the traditional manner.

Features

- Compatible with 830 series detectors
- Drives a remote indicator
- Detector locking pin provided with every base
- Snap fits to the Time Saver Ceiling Tile Adaptor
- Fits directly to a British or European electrical back box
- Temporary park position
- Break-outs for surface mount

Order Code

517.050.041 4B 4" Detector Base

4B-D 4" Diode Continuity Base



The 4B-D Continuity Base is a standard 4 inch base fitted with a continuity diode, for use with all Series 600 detectors. The base is designed to ensure that conventional systems meet the requirements of BS5839 Pt:1 for callpoints placed after detectors.

Features

- Compatible with Series 600 Low Profile Detectors
- Designed for two wire operation
- Facility to drive a remote indicator
- A breakout locking key is provided as an integral part of the base. It can be used to lock the detector into position
- A temporary park position is provided so that the field wiring can be tested with the detector in situ
- Maybe fitted directly to a British or European conduit box or directly onto the ceiling

Order Code

517.050.045 4B-D 4" Diode Continuity Base

4B-6A 4" to 6" Adaptor



The 4B-6A 4" to 6" Adaptor is designed for use with U.S. style 6" electrical back boxes and provides a flush architectural trim between the electrical box and the 4B-C 4" continuity base. It can also be fixed directly to a ceiling and used to conceal marks left when older, large diameter detectors are replaced with MZX Technology.

Features

- Adapts 6" electrical boxes to fit the 4B-C 4" base
- Architectural trim for neat appearance
- Concealed fixings
- Use to conceal marks left by old detectors

Order Code

517.050.054 4B-6A 4" to 6" Base Adaptor

2.18

Standard & Functional Conventional Detector Bases

Ceiling Tile Adapter

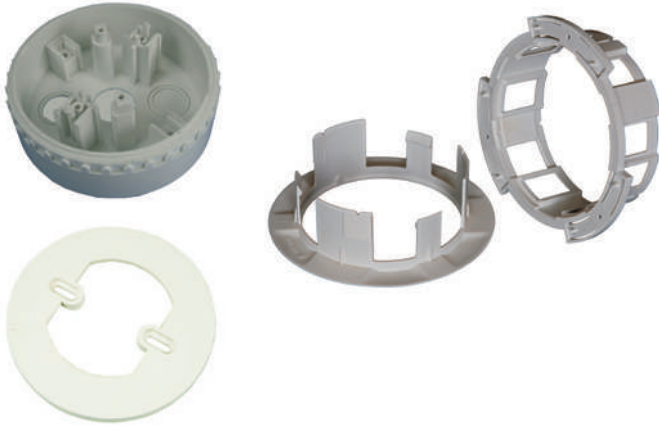

The Time Saver Ceiling Tile Adaptor is used with the 4" snap fit base and consists of three parts, a bezel and clamp that are fitted to the ceiling tile and a back-box that carries the detector and base assembly. It is available as a complete unit or alternatively, the back-box can be ordered separately, as can the bezel and clamp assembly. Ordering the parts separately may be preferred if there is an extended period before the false ceiling is installed e.g. "shell and core" projects. Requires a 127mm diameter hole. The CTA adaptor plate allows the Time Saver Ceiling Tile Adaptor to be used with other devices such as the AV Base, 802SB or Mini Firecryer.

Features

- Cuts installation time by 30%
- Commission the system before the suspended ceiling is installed
- Suitable for ceiling tiles from 1mm to 30mm thick
- Made from flame retardant material
- No additional back-box is required
- Time saver is designed for use with a new snap-fit 4" detector base
- Adaptor available for use with the AV base & other devices

Order Codes

517.050.060	Ceiling Tile Adaptor Kit consists of 1 x 517.050.056 and 1 x 517.050.057
517.050.056	CTA-BB CTA Back Box
517.050.057	CTA-BC CTA Bezel and Clamp
517.050.058	CTA-AP CTA Adaptor Plate

Functional Detector Bases Tyco MKII Sounder Base



A new low current range of sounder bases for use with Conventional Fire Alarm Control Panels.

Features

- Manufactured to EN54 part 3
- Integral sounder and detector base
- Volume and tone adjustable after installation
- Low Power Synchronisation
- Do not require use of a standard base (maybe installed directly onto a standard besa box)

Order Codes

577.001.035	601SB Conventional Sounder Base
577.001.037	601SBD Conventional Diode Sounder Base
577.001.036	602SB 2 Wire Line Powered Sounder Base
577.001.038	602SBD 2 Wire Line Powered Diode Sounder Base
517.050.022	Volume Pot Spare Cover (1 sheet of 144)
517.050.005	4" Detector Base Locking Pin Kit (PK100)

Remote Indication LED



All detector bases have the ability to drive a remote LED in the event that the installed position of the detector is not easily visible.

Features

- UK Single gang mounting
- High intensity red LED

Order Code

540.003.006 Remote LED

4B-EM 4" Euro Mount



The euro-mounting base provides a matching back box, which allows the 4" bases to be ceiling mounted with conduit entries for standard 18 and 21mm conduit.

Features

- 2 x 18 mm conduit entries
- 2 x 21 mm conduit entries
- Fits all 4" Bases
- Accepts up to 8 accessory terminals

Order Codes

517.050.052 4B-EM 4" Euro Mount
517.050.612 Base Accessory terminal kit (pack of 10)

4B-DHM Deck Head Mounting



For humid and environmentally challenging applications such as marine or offshore installations, the 4B-DHM deck head mount provides a sealed waterproof mounting which protects the electrical connections in the base. It can be screwed, bolted or welded to the deckhead. Supplied with 1 terminal. If more are required, use the optional base accessory terminal kit.

Features

- 4 x 20 mm gland entries
- Fits ALL 4" bases
- IP55 with supplied gasket

Order Codes

517.050.051 4B-DHM Deckhead Mount
517.050.612 Base accessory terminal kit (pack of 10)

Protective Detector Cage



Robust steel protective cage for Series 800 detector ranges using the 5" bases. Ideal for schools and sporthalls or whenever detectors need protection. Strong coated steel construction with 4 point fitting.

Order Code

517.050.614 CW-5B Detector Cage

2.20

Conventional Detector Base Ancillaries

Protective Detector Sounder Base Cage



White powder coated steel protective cage for Series 800 Detectors fitted with a sounder base. Internal dimensions: 120 mm dia x 80 mm deep.

Order Code

517.050.011 Steel Protective Detector Cage

SMP69 Duct Probes



Warning: Duct probe units sited in the common duct work to several extract grills may fail to respond to smoke from any one extract due to the effect of dilution. The SMP units will not respond to airflow of less than 1.5 m/sec.

Where smoke within duct work needs to be detected these duct probe units provide an economical solution, for use with series 600 detectors. The SMP Duct Probe Units are designed to be installed in air conditioning supply and exhaust ducts for the purpose of monitoring the airflow for smoke and combustion products.

For general applications it is recommended that 600 series photoelectric smoke detectors rather than ionisation smoke detectors are used.

The SMP stainless steel probe unit is designed to withstand the demanding environments of the offshore oil and gas industries. The units are designed to operate in airspeeds of 1.5 to 25 metres per second. A range of sampling tubes from 525mm to 1,575mm are available.

Technical Information

Operating temperature:	-20°C to +70°C
Storage temperature:	-25°C to +80°C
Relative Humidity:	0 to 95%
SMP69 housing:	Stainless steel 316 housing with transparent polycarbonate cover
SMP69 dimensions:	90H x 150W x 225L mm
Weight:	1.2 Kg

Order Codes

517.025.035	SMP69 Stainless Steel Duct Probe unit and universal detector base for Series 600/800 Detectors
517.025.028	DPS450 Probe tube stainless steel 450 mm and exhaust
517.025.029	DPS600 Probe tube stainless steel 600 mm and exhaust
517.025.030	DPS750 Probe tube stainless steel 750 mm and exhaust
517.025.031	DPS900 Probe tube stainless steel 900 mm and exhaust
517.025.032	DPS1200 Probe tube stainless steel 1200 mm and exhaust
517.025.033	DPS1500 Probe tube stainless steel 1500 mm and exhaust

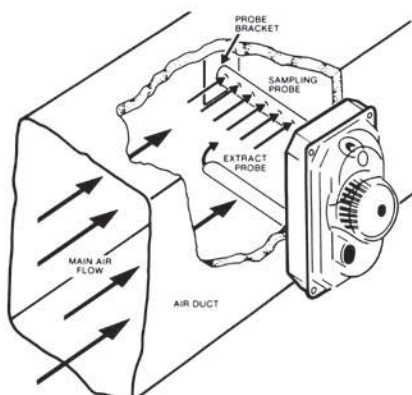

DPK6 Duct Probe



The DPK6 duct probe units have been developed to detect smoke in ventilation ducts. They offer significant benefits in terms of performance and installation. The system comprises a single duct probe tube and housing specially designed for optimum airflow through the smoke detector and suitable for use in incoming, outgoing and circulation air ducts of ventilation and conditioning systems. The duct probes can operate across a wide range of airflow speeds and are designed to comply with prEN 54-27 and VdS.

Unlike more traditional duct probe units that employ an inlet and exhaust tube with sampling holes, the DPK6 unit uses a highly efficient single sampling tube that is slotted along its length. This allows the sampling tubes to be cut to the desired length whilst maintaining maximum efficiency.

In order to reduce the time required to test the duct probe detector during routine maintenance, an aperture is provided that allows aerosol test gas to be directed at the detector without having to dismantle the unit.

Accessories

Tyco Fire Protection Products offers 3 lengths of the duct probe tubes. The tube is made of aluminium and can easily be shortened to suit the span of the air duct. Where the unit is mounted on insulated or circular air ducts, the DPK6-MB mounting bracket is required.

Features

- DPK6 for use with Generation6 multi-sensor detectors 850PH and 830PH with built-in 4B-C
- 4" Continuity Base
- Designed to comply with prEN 54-27
- One-pipe air sampling system
- Patented venturi pipe and duct housing
- Test hole on cover
- Simple installation
- Simple service and maintenance

Order Codes

517.025.056	DPK6 Duct Probe with 4B-C 4" Continuity Base
517.025.058	DPK6-60 - Duct Probe Tube 60 cm
517.025.059	DPK6-150 - Duct Probe Tube 150 cm
517.025.060	DPK6-280 - Duct Probe Tube 280 cm
517.025.061	DPK6-MB - Duct Probe Mounting bracket
517.025.055	DPKF - Filter

2.22

Conventional Callpoints

MCP Series Callpoints



A comprehensive range of callpoints for use with conventional systems. All the callpoints are designed to enable an alarm signal to be given by breaking a glass element.

This operates a switch and is indicated by an LED indicator. If required, an optional transparent hinged cover may be installed to guard against accidental operation.

Features

- Integral LED indicator for easy identification of operation
- Surface or flush mounting
- Extensive range of conventional callpoints
- Test key facility, speeds maintenance visits
- Optional transparent hinged cover
- Hazardous areas models available (See Special Hazards Section)
- IP67 Waterproof models for external applications

Technical Information (Indoor and Outdoor)

Housing:	PC/ABS
Operating Temperature	Outdoor: -30°C TO +70°C Indoor: -10°C TO +55°C
Relative Humidity:	Up to 95% RH (non-condensing)

Model	Colour	Type	IP Rating	R4/R1 Ohms
MCP200	Red	Conventional Alert	24D	120/470
MCP210	Red	Conventional Evacuate	24D	47/39
MCP230	Red	Conventional Alert	67	120/470
MCP270	Yellow	Conventional Evacuate	24D	47/39
Keyswitch	White	Conventional	24D	Not Applicable

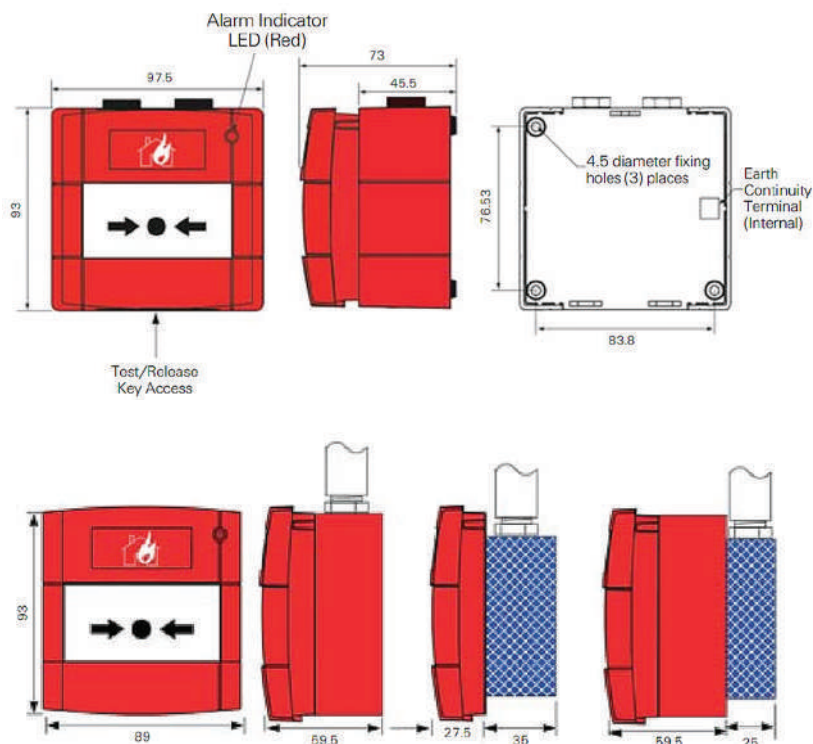

Conventional MCP200 Callpoint



The MCP200 is a red indoor callpoint with 'alert' resistors and LED indicator. The MCP200 is LPCB approved.

Order Codes

514.001.142.A	MCP200 No backbox - ADT brand
514.001.142.T	MCP200 No backbox - Thorn brand
514.001.142.Y	MCP200 No backbox - Tyco brand

Conventional MCP210 Callpoint



The MCP210 is a red indoor callpoint with LED indicator and evacuate resistors. The MCP210 is LPCB approved.

Order Codes

514.001.143.A	MCP210 No bacbox - ADT brand
514.001.143.T	MCP210 No backbox - Thorn brand
514.001.143.Y	MCP210 No backbox - Tyco brand

Conventional MCP230 Callpoint



The MCP230 is a IP67 red outdoor callpoint with "alert" resistors and LED indicator and is LPCB approved.

Order Codes

514.001.110.A	MCP230 ADT branded
514.001.110.T	MCP230 Thorn branded
514.001.110.Y	MCP230 Tyco branded

Prescient III Indoor Alarm Callpoint



A manual semi flush mounted break glass callpoint with integral alarm LED and activation resistor making it compatible with the Prescient III Suppression Panel.

Order Codes

2501012	Conventional Manual Call Point with Glass Element (No Backbox) Supplied with test key.
515.001.021	Backbox for callpoints to allow surface mounting.

Prescient III Outdoor Alarm Callpoint



A weatherproof manual alarm call point with integral alarm LED and activation resistor making it compatible with the Prescient III Suppression Panel. Operation is by break glass.

Order Code

2501176	Conventional Weather Proof Manual Call Point with Glass Element. Supplied with backbox and test key.
---------	--

Special Marine Callpoint



A range of marine-specific callpoints which come complete with an integral LED indicator.





Order Codes

514.001.112	MCP260M Marine callpoint - IP67
514.001.113	MCP250M Marine callpoint - No backbox

2.24

Conventional Callpoints Ancillaries



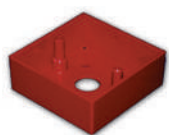
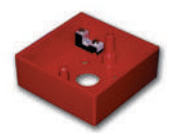

Callpoint Ancillaries

	Description	Order Codes
	A white keyswitch in a callpoint housing featuring the words "Bomb Alert" in English.	514.002.002.A
	Red M141 spacer for red CP200/800 KAC callpoints	90-107
	Callpoint hinged cover for use with MCP callpoints models (Colour Clear)	515.001.128
	Black callpoint bezel for CP200/800 models.	515.001.026
	Test key for all MCP and CP style callpoints	515.001.045

Callpoint Back Boxes

	Description	Order Codes
	Standard Red surface mounting back box for MCP & CP indoor callpoints	515.001.021
	SR2-T Optional Back Box (2 terminals)	10-115

Spare Callpoint Glasses

	Description	Order Codes
	<p>EN54 Part 11 Spare Glass for MCP and CP series Callpoints (Pack of 5)</p> <p>CP200 Glasses, clear English text on white bckgd. No logo (Pack of 5)</p> <p>Deformable operating unit "glass" for use in place of glasses, for kitchens or other areas where glass is not acceptable. For MCP callpoints only</p> <p>CP200 spare glasses, black Arabic/English text with Thorn Security logo on white background (Pack of 5)</p> <p>CP200 Spare glasses, black Arabic text on a white background (Pack of 5)</p> <p>CP200 Spare glasses for CP200 white Dutch text on clear background (Pack of 5)</p>	<p>515.001.119</p> <p>515.001.025</p> <p>515.001.127</p> <p>515.001.024</p> <p>515.001.014</p> <p>515.001.023</p>
	<p>Walsall callpoint glasses (Pack of 10) for service spares. The Walsall callpoint is an old square callpoint with round glass</p>	<p>515.001.010</p>
	<p>ZF121 Callpoint glass (Pack 10) for service spares. The ZF121 is a square metal fronted AFA MINERVA callpoint typically used on Firefinder, System 1100, ZF/System 1200, CP and CT system</p>	<p>515.001.003</p>
	<p>CP100A glass unscored (Pack 10) for service spares. The CP100A has a large square glass to the edge of the callpoint. Used on the same AFA systems as the ZF121</p>	<p>515.001.009</p>

2.26

Conventional Callpoints Ancillaries

UNIVERSAL STOPPER



Break seal (pack of 10)

Features

- Prevents accidental operation of callpoints
- Strong polycarbonate construction
- Break Seal provided. (Use is optional)

Order Codes

515.001.033	Break Seal Conversion for Old Style STOPPER
STI/BS	Break seals (Pack of 10)

The UNIVERSAL STOPPER provides protection from malicious or accidental activation of manual callpoints. Available for flush or surface mounted callpoints the UNIVERSAL STOPPER is also available with optional high pitch sounder which is activated when the lid is lifted.

A Break Seal is supplied with all models, to provide extra protection if required.

WARNING: Break Seals should only to be fitted by agreement with relevant fire authorities.

The UNIVERSAL STOPPER is suitable for all callpoints up to 100 mm square.

	Flush	Surface	With Sounder	Weather-proof
STI-13110FR UNIVERSAL STOPPER		✓ 37 mm		✓
STI-13010FR UNIVERSAL STOPPER	✓			✓
STI-13020FR UNIVERSAL STOPPER	✓		✓ 96 dB	✓
STI-13120FR UNIVERSAL STOPPER		✓ 37 mm	✓ 96 dB	✓
STI-1100 STOPPER II			✓ 96 dB	
STI-1130 STOPPER II		✓ 50 mm	✓ 96 dB	
STI-1200 STOPPER II	✓			
STI-1230 STOPPER II		✓ 50 mm		
STI-1230/BS STOPPER II Red Break Seal		✓ 50 mm		
STI-1250 WEATHER STOPPER II	✓			✓
STI-3150 WEATHER STOPPER II		✓ 50 mm		✓
STI-3150/BS WEATHER STOPPER II Red Break Seal		✓ 50 mm		

	Flush Kit	Surface Kit
UNIVERSAL STOPPER	STI-13010FR	STI-13110FR
UNIVERSAL STOPPER with sounder	STI-13020FR	STI-13120FR

	UNIVERSAL STOPPER	STOPPER II
Max. Callpoint size	100 x 100 mm	160 x 160 mm
Max. Callpoint depth	57.5	120
	(add 37 mm surface)	

STOPPER II



The STOPPER II is constructed from tough UV stabilised polycarbonate. Physically larger than the UNIVERSAL STOPPER the STOPPER II extends the number of products to which these tough multi-purpose covers can protect.

It consists of a strong tamper-proof clear polycarbonate cover and frame that fits easily over such products as break glass callpoints.

Features

- Strong polycarbonate construction
- Tamper resistant

Order Code

515.001.034 STOPPER II Surface - Red

STOPPER II can also be fitted with an integral battery powered sounder which activates if the cover is lifted.

The STOPPER II is suitable for callpoints up to 160 mm square.

UNIVERSAL STOPPER & WEATHER STOPPER II



The UNIVERSAL STOPPER and WEATHER STOPPER II extends the life of weather exposed devices, such as break glass callpoints, by offering protection against harsh conditions and environments. Experience has shown that this protective cover can extend the life of products installed in saline atmospheres, such as oil rigs and ship decks.

While offering environmental protection the UNIVERSAL STOPPER and WEATHER STOPPER II are constructed from tough UV stabilised polycarbonate which will also guard against tampering, vandalism or accidental operation of devices such as emergency switches.

Features

- Strong polycarbonate construction
- Provides environmental protection
- Ideal for indoor/outdoor applications

Order Codes

STI-13110FR UNIVERSAL STOPPER Surface Red
515.001.035 WEATHER STOPPER II Red

2.28

Conventional Callpoints Ancillaries

STOPPER II Dimensions

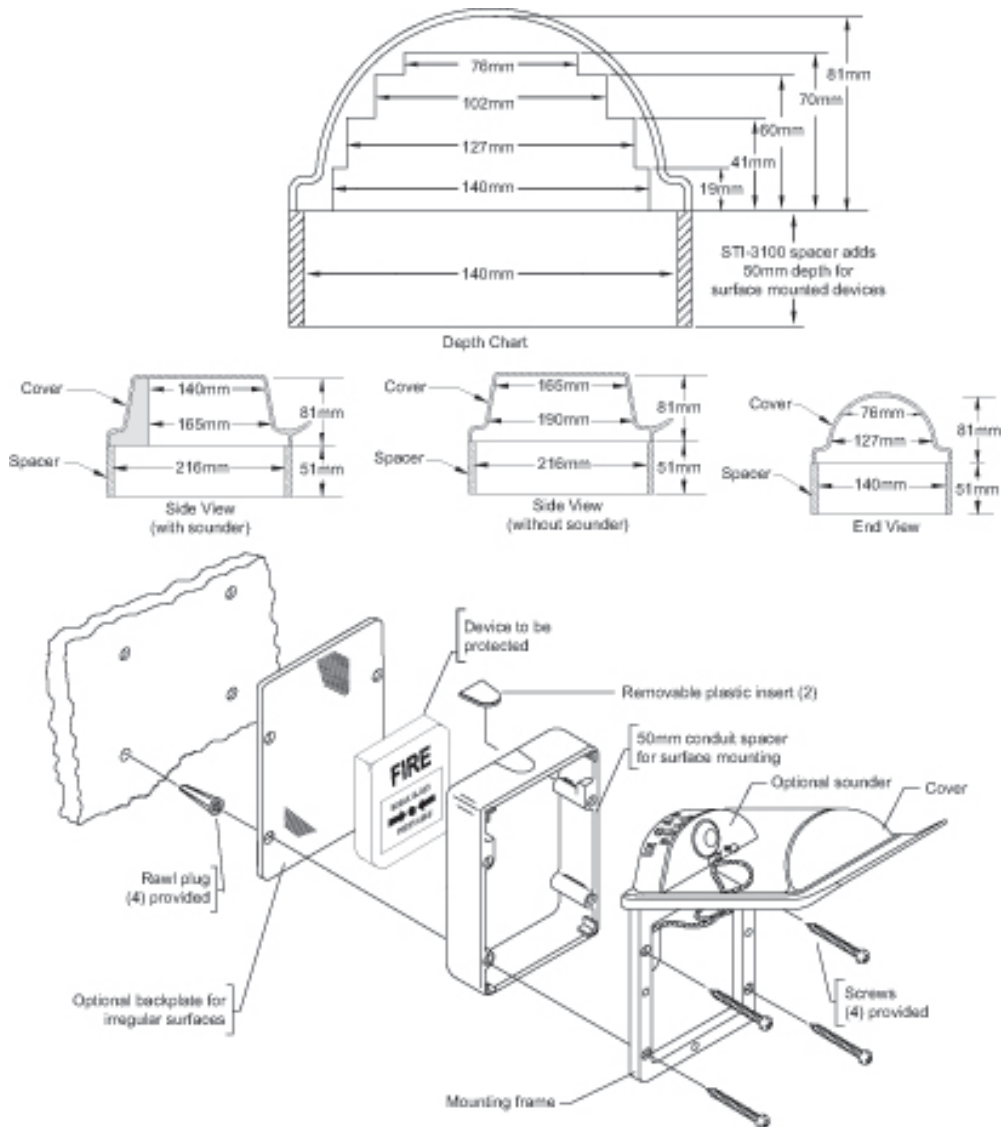

UNIVERSAL STOPPER Dimensions

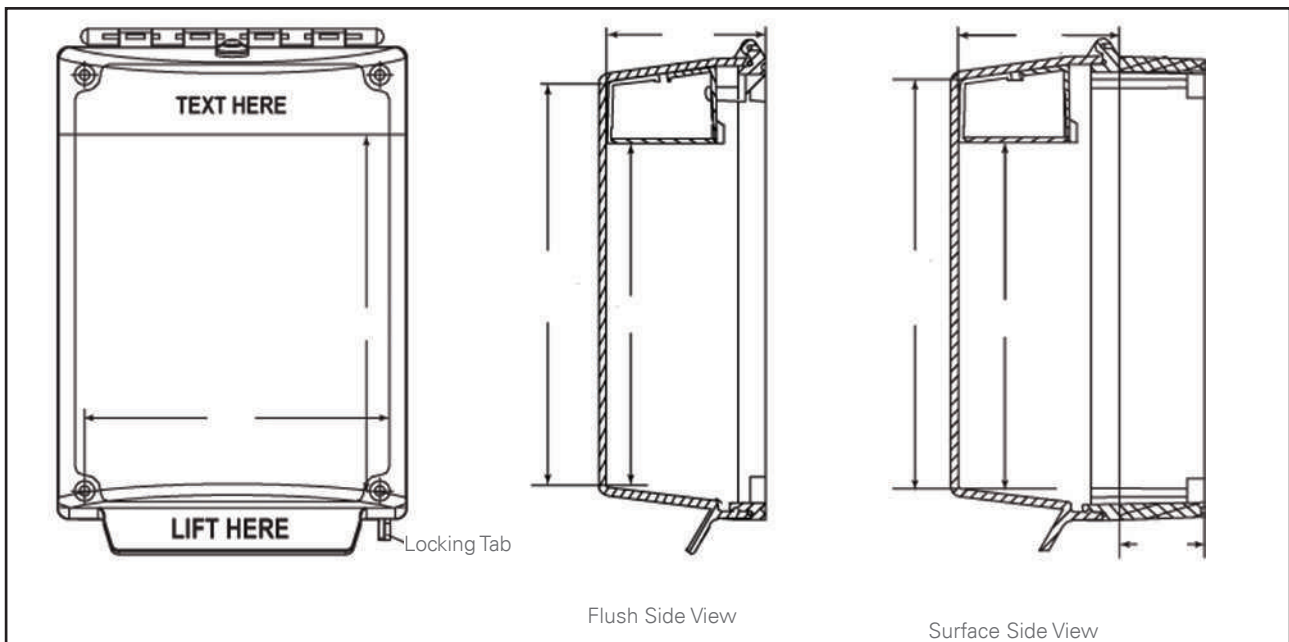

Smoke Beam/CCTV Guard



Technical Information

Dimensions: 260H x 200W x 321D mm

Order Code

516.015.009 STI9625 Smoke beam/CCTV guard

The Smoke Beam/CCTV Guard is manufactured from tough coated steel rod and is designed to protect projected beam detectors or CCTV cameras from vandalism or accidental damage.

Suitable for use with System Sensor, Hochiki and Fireray 2000 detectors.

Breakglass Keybox



Order Code

515.001.043 STI6720 Keybox with printed glass

This tough polycarbonate breakglass keybox is available to protect emergency keys.

2.30

Service & Spares

Order Codes

T1200 CONVENTIONAL MARINE PANEL

509.023.001	C1626 4 Zone Panel Motherboard with AC PSU
509.023.002	C1626 4 Zone Panel Motherboard without AC PSU
509.023.003	C1627 16 Zone Panel Motherboard without AC PSU
509.023.004	C1627 16 Zone Panel Motherboard without AC PSU FORT1232
509.023.011	C1626 Repeater Motherboard with AC PSU
509.023.012	C1626 Repeater Motherboard without AC PSU
509.023.021	C1628 4 Zone Panel Display PCB
509.023.022	C1628 16 Zone Panel Display PCB
509.023.023	C1629 32 Zone Panel Display PCB
509.023.031	C1628 16 Zone Repeater Display PCB
509.023.032	C1629 32 Zone Repeater Display PCB
2605060	C1630 Output Expansion Interface PCB
509.023.042	C1632 16 Zone Panel Expansion PCB
509.023.051	PS136 5.0 AMP 110/230 VAC PSU
509.023.052	PS40 1.5 AMP 24VDC PSU
509.023.061	T1200 & T1200-C Spare Key Set

MZX-c+ CONVENTIONAL PANEL

557.201.508	MZX-c+ Spare Key Set
2605071	MZX-c+ 5.0 AMP PSU - C1652
2000636	MZX-c+ Transformer 1.5 A
2000637	MZX-c+ Transformer 3.0 A
2000638	MZX-c+ Transformer 5.0 A

MZX-e EXTINGUISHING PANEL

557.201.508	MZX-e Spare Key Set
-------------	---------------------

EXTINGUISHING ANCILLARIES

599.001.012	Lamp 28 V 60 mA (MCC) for T525
599.001.029	24 V5WSBC SP Bulb for E1/E3

MANUAL ALARM CALLPOINTS

515.001.003	ZF121 Callpoint Glass (PK10)
515.001.009	CP100A Callpoint Glass Unscored (PK10)
515.001.010	Walsall Callpoint Glass (PK10)
515.001.014	CP200 Callpoint Glass Arabic (PK5)
515.001.023	CP200N Callpoint Glass (PK5)
515.001.024	CP200 Callpoint Arabic / English Glass (PK5)
515.001.025	CP200 Callpoint English Glass NO LOGO (PK5)
515.001.033	Stopper Break Seal Kit - Red (PK1)
515.001.045	MCP/CP Callpoint Test Key (PK1)
515.001.119	MCP/CP Callpoint EN54 PT11 Spare Glass (PK5)
515.001.127	Deformable MCP Element (PK1)



Sounders & Beacons
EN-54 Visual Alarm Devices
Loop Powered Sounders
Bells
Sounders
Beacons

3.02

EN-54 Visual Alarm Devices

P80AVW, P80AVR & P85AVR EN-54 Addressable Wall Sounder VADs



Sounders are considered as the most important of all the alarm devices. It is a mandatory requirement that sounders are used as an integral part of the fire detection and alarm system.

VADs are used to supplement sounders, providing an effective means of alerting and evacuating occupants of the building, as part of its fire safety strategy.

The P80AV range of compact addressable wall sounders with a Visual Alarm Device (VAD) includes three models with the same low current and high output specification; red and white body indoor models plus an IP rated version for either outdoor or harsh environment applications.

EN54-23 now provides clarity by standardizing requirements, test methods and performance criteria of Visual Alarm Devices (VADs) and ensures all device parameters are measured in a uniform manner throughout Europe.

Main Requirements from EN54-23 are:

- The coverage volume (i.e. volume within which required illumination is achieved) must be stated on the product or supporting documentation.
- The VAD should meet the requirement for coverage volume of at least one of the following categories: W (Wall), C (Ceiling), O (Open Class).
- Required illumination of 0.4 lux on a surface perpendicular to the direction of the light emitted from the VAD.
- The rate of flash should be stated between 0.5Hz and 2Hz.
- The devices must be classified as Type A, indoor and Type B, outdoor.

Features

- A compact and unobtrusive sounder solution
- Reflective Sound Monitoring (RSM)
- Reflective Light Monitoring (RLM)
- Automatic self-test
- Shorter light pulse for faster response
- Indoor and outdoor versions
- Indoor models can be semi-flush or surface mounted including a choice of shallow or deep back box
- IP rated option has a deep surface back box for use with suitable IP-rated glands and cabling
- Power and data from the loop. No additional wiring or power supplies required
- Built-in line isolator
- 16 selectable tones
- Realistic conventional bell tone
- 2 selectable volumes
- 2 selectable flash rates
- Select the tone volume and flash rate using panel configuration software
- Independent addressable control of sounder / beacon
- Different tones available for fire alarm and class change
- Aesthetically pleasing wall mount option
- A locking pin/screw supplied which prevents unauthorized removal

Order Codes

- 576.080.007 P80AVW Addressable Wall Sounder VAD White
- 576.080.008 P80AVR Addressable Wall Sounder VAD Red
- 576.080.009 P85AVR Addressable Wall Sounder VAD IP Red
- 557.080.007 S-BOXR Shallow Surface Back Box For Indoor Wall Sounder / VAD / VID Red
- 557.080.008 S-BOXW Shallow Surface Back Box For Indoor Wall Sounder / VAD / VID White
- 557.080.010 A-BOX Flush Back Box Adaptor For Indoor Wall Sounder / VAD / VID
- 557.080.011 D-BOXR Deep Surface Back Box For Indoor Wall Sounder / VAD / VID Red
- 557.080.012 D-BOXW Deep Surface Back Box For Indoor Wall Sounder / VAD / VID White

Technical Information

	P80AVW	P80AVR	P85AVR
Coverage Volume Code:	W-2.4-7.5	W-2.4-7.5	W-2.4-7.5
Devices per Loop:	Up to 73 (*)	Up to 73 (*)	Up to 73 (*)
Flash Rate:	0.5 / 1Hz	0.5 / 1Hz	0.5 / 1Hz
Dimensions (WxHxD):	89x135x40mm (Without backbox)	89x135x40mm (Without backbox)	105x153x97mm (With IPbackbox)
Sound Output @ 1m:	Up to 100dBA	Up to 100dBA	Up to 100dBA
Body Colour:	White	Red	Red
Flash Colour:	White	White	White
IP Code:	IP21C	IP21C	IP55
Approvals:	EN54-3, 23, 17	EN54-3, 23, 17	EN54-3, 23, 17

(*) Full intensity VAD with sounder at high volume, 1 A loop.
Loop quantities are for guidance only and should be verified with the loop calculator.

Wall Category

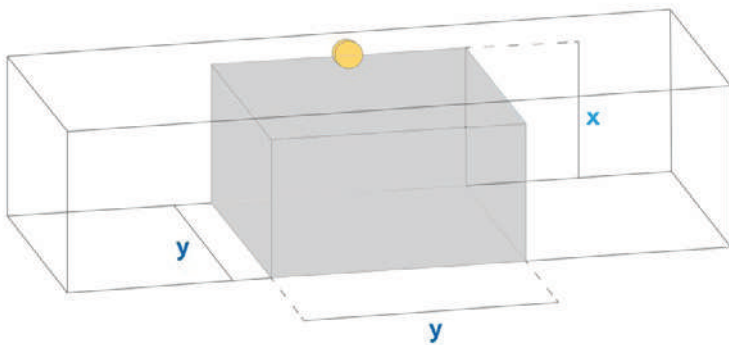

Coverage volume code:

W – (x) - (y)

W = wall mounted

x = maximum mounting height

y = length and width in metres of the cubic volume covered (to a minimum level of 0.4 lux) when the device is mounted to the wall at a height of x

Ceiling Category

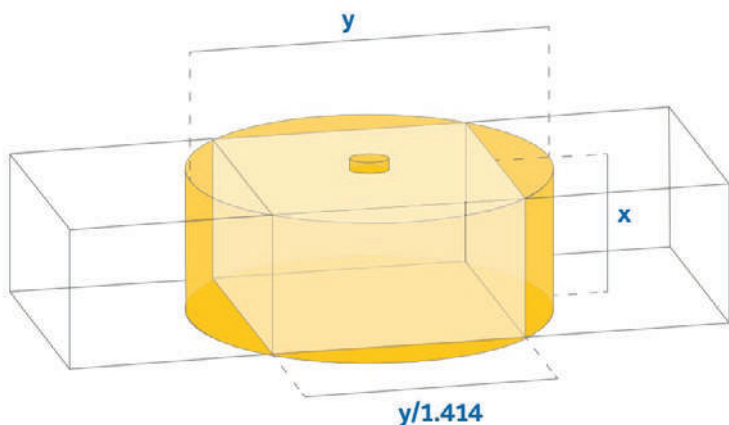

Coverage volume code:

C – (x) - (y)

C = wall mounted

x = maximum mounting height

y = diameter in metres of the cylindrical volume covered (to a minimum level of 0.4 lux) when the device is mounted to the ceiling at a height of x

Open Class Category

The coverage volume and its shape are specified by the manufacturer and include mounting position and orientation alongside any restriction on the mounting height.

3.04

EN-54 Visual Alarm Devices

P80AIW, P80AIR & P85AIR Addressable Wall Sounder VIDs



Sounders are considered as the most important of all the alarm devices. It is a mandatory requirement that sounders are used as an integral part of the fire detection and alarm system.

VIDs are generally used as a supplementary indication to raise situational awareness. But, when an event occurs, they cannot be used as the only means to alert people to a potential hazard.

The P80AI range of compact addressable wall sounders with the Visual Indicating Device (VID) includes three models with the same low current and high output specification; red and white body indoor models plus an IP rated version for either outdoor use or for harsh environment applications.

EN54-23 now provides clarity by standardizing requirements, test methods and performance criteria of Visual Alarm Devices (VADs) and ensures all device parameters are measured in a uniform manner throughout Europe.

Main Requirements from EN54-23 are:

- The coverage volume (i.e. volume within which required illumination is achieved) must be stated on the product or supporting documentation.
- The VAD should meet the requirement for coverage volume of at least one of the following categories: W (Wall), C (Ceiling), O (Open Class).
- Required illumination of 0.4 lux on a surface perpendicular to the direction of the light emitted from the VAD.
- The rate of flash should be stated between 0.5Hz and 2Hz.
- The devices must be classified as Type A, indoor and Type B, outdoor.

Features

- A compact and unobtrusive sounder solution
- Reflective Sound Monitoring (RSM)
- Light is electronically monitored by the control panel
- Automatic self-test
- Indoor and outdoor versions
- Indoor models can be semi-flush or surface mounted including a choice of shallow or deep back box
- IP rated option has a deep surface back box
- Power and data from the loop. No additional wiring or power supplies required
- Built-in line isolator
- 16 selectable tones
- Realistic conventional bell tone
- 2 selectable volumes
- 2 selectable flash rates
- Select the tone volume and flash rate using panel configuration software
- Independent addressable control of the sounder and beacon
- Different tones can be used for fire alarm and class change
- Aesthetically pleasing rectangle wall mount option
- A locking pin/screw supplied which prevents unauthorized removal

Order Codes

- 576.080.011 P80AIW Addressable Wall Sounder VID White
- 576.080.012 P80AIR Addressable Wall Sounder VID Red
- 576.080.013 P85AIR Addressable Wall Sounder VID IP Red
- 557.080.007 S-BOXR Shallow Surface Back Box For Indoor Wall Sounder / VAD / VID Red
- 557.080.008 S-BOXW Shallow Surface Back Box For Indoor Wall Sounder / VAD / VID White
- 557.080.010 A-BOX Flush Back Box Adaptor For Indoor Wall Sounder / VAD / VID
- 557.080.011 D-BOXR Deep Surface Back Box For Indoor Wall Sounder / VAD / VID Red
- 557.080.012 D-BOXW Deep Surface Back Box For Indoor Wall Sounder / VAD / VID White

Technical Information

	P80AIW	P80AIR	P85AIR
Devices per Loop:	Up to 92 (*)	Up to 92 (*)	Up to 92 (*)
Flash Rate:	0.5 / 1Hz	0.5 / 1Hz	0.5 / 1Hz
Dimensions (WxHxD):	89x135x40mm (Without backbox)	89x135x40mm (Without backbox)	105x153x97mm (With IP backbox)
Sound Output @ 1m:	Up to 100dBA	Up to 100dBA	Up to 100dBA
Body Colour:	White	Red	Red
Flash Colour:	Red	Red	Red
IP Code:	IP21C	IP21C	IP55
Approvals:	EN54-3, 17	EN54-3, 17	EN54-3, 17

(*) Beacon at 0.5Hz with sounder at high volume, 1A loop.

Loop quantities are for guidance only and should be verified with the loop calculator.

Wall Category

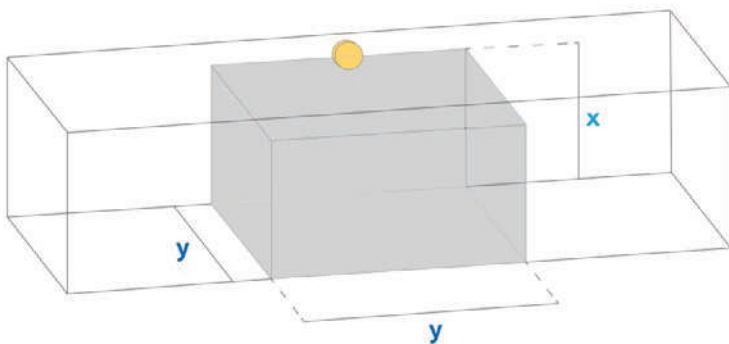

Coverage volume code:

W – (x) - (y)

W = wall mounted

x = maximum mounting height

y = length and width in metres of the cubic volume covered (to a minimum level of 0.4 lux) when the device is mounted to the wall at a height of **x**

Ceiling Category

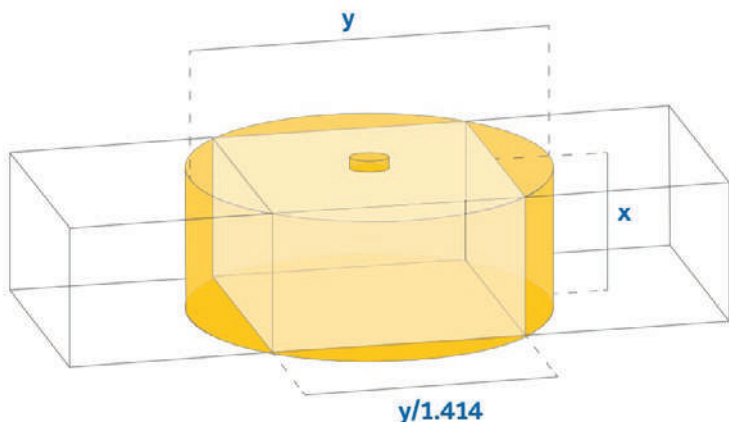

Coverage volume code:

C – (x) - (y)

C = wall mounted

x = maximum mounting height

y = diameter in metres of the cylindrical volume covered (to a minimum level of 0.4 lux) when the device is mounted to the ceiling at a height of **x**

Open Class Category

The coverage volume and its shape are specified by the manufacturer and include mounting position and orientation alongside any restriction on the mounting height.

3.06

EN-54 Visual Alarm Devices

P80SW, P80SR & P85SR Addressable Wall Sounder



Sounders are considered as the most important of all the alarm devices. It is a mandatory requirement that sounders are used as an integral part of the fire detection and alarm system.

The P80S range of compact addressable wall sounders includes three models with the same low current and high output specification; red and white body indoor models plus an IP rated version for either outdoor use or for harsh environment applications.

EN54-23 now provides clarity by standardizing requirements, test methods and performance criteria of Visual Alarm Devices (VADs) and ensures all device parameters are measured in a uniform manner throughout Europe.

Main Requirements from EN54-23 are:

- The coverage volume (i.e. volume within which required illumination is achieved) must be stated on the product or supporting documentation.
- The VAD should meet the requirement for coverage volume of at least one of the following categories: W (Wall), C (Ceiling), O (Open Class).
- Required illumination of 0.4 lux on a surface perpendicular to the direction of the light emitted from the VAD.
- The rate of flash should be stated between 0.5Hz and 2Hz.
- The devices must be classified as Type A, indoor and Type B, outdoor.

Features

- A compact and unobtrusive sounder solution
- Reflective Sound Monitoring (RSM)
- Automatic self-test
- Indoor and outdoor versions
- Indoor models can be semi-flush or surface mounted including a choice of shallow or deep back box
- IP rated option has a deep surface back box
- Power and data from the loop. No additional wiring or power supplies required
- Built-in line isolator
- 16 selectable tones
- Realistic conventional bell tone
- 2 selectable volumes
- Select the tone volume using panel configuration software
- Different tones can be used for fire alarm and class change
- Rectangle wall mount for an aesthetically pleasing option
- A locking pin/screw supplied which prevents unauthorized removal

Order Codes

- 576.080.003 P80SW Addressable Wall Sounder White
- 576.080.004 P80SR Addressable Wall Sounder Red
- 576.080.005 P85SR Addressable Wall Sounder IP
- 557.080.007 S-BOXR Shallow Surface Back Box For Indoor Wall Sounder / VAD / VID Red
- 557.080.008 S-BOXW Shallow Surface Back Box For Indoor Wall Sounder / VAD / VID White
- 557.080.010 A-BOX Flush Back Box Adaptor For Indoor Wall Sounder / VAD / VID
- 557.080.011 D-BOXR Deep Surface Back Box For Indoor Wall Sounder / VAD / VID Red
- 557.080.012 D-BOXW Deep Surface Back Box For Indoor Wall Sounder / VAD / VID White

Technical Information

	P80SW	P80SR	P85SR
Devices per Loop:	Up to 119 (*)	Up to 119 (*)	Up to 119 (*)
Dimensions (WxHxD):	89x135x40mm (Without backbox)	89x135x40mm (Without backbox)	105x153x97mm (With IP backbox)
Sound Output @ 1m:	Up to 100dBA	Up to 100dBA	Up to 100dBA
Body Colour:	White	Red	Red
IP Code:	IP21C	IP21C	IP55
Approvals:	EN54-3, 17	EN54-3, 17	EN54-3, 17

(*) Sounder set at high volume, 1 A loop.

Loop quantities are for guidance only and should be verified with the loop calculator.

Wall Category

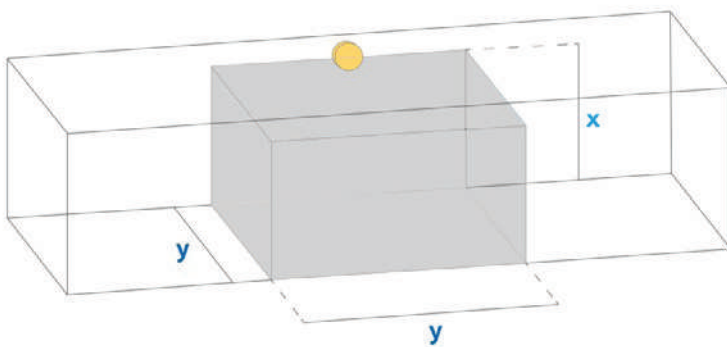

Coverage volume code:

W – (x) - (y)

W = wall mounted

x = maximum mounting height

y = length and width in metres of the cubic volume covered (to a minimum level of 0.4 lux) when the device is mounted to the wall at a height of x

Ceiling Category

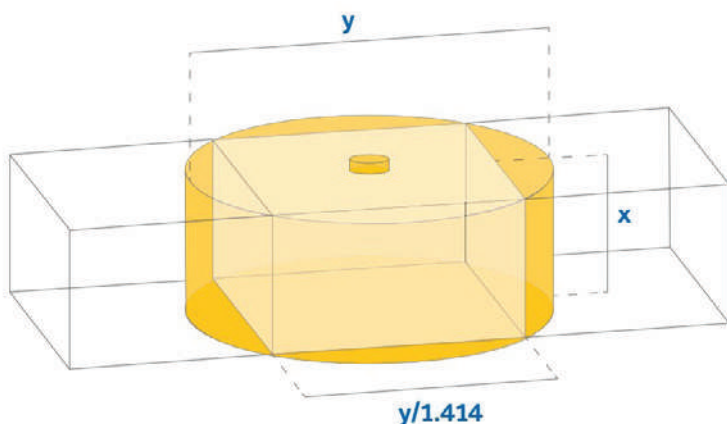

Coverage volume code:

C – (x) - (y)

C = wall mounted

x = maximum mounting height

y = diameter in metres of the cylindrical volume covered (to a minimum level of 0.4 lux) when the device is mounted to the ceiling at a height of x

Open Class Category

The coverage volume and its shape are specified by the manufacturer and include mounting position and orientation alongside any restriction on the mounting height.

3.08

EN-54 Visual Alarm Devices

P80AVB & P81AVB Addressable Sounder VAD Bases



Sounders are considered as the most important of all the alarm devices. It is a mandatory requirement that sounders are used as an integral part of the fire detection and alarm system.

VADs are used to supplement sounders, providing an effective means of alerting and evacuating occupants of the building, as part of its fire safety strategy.

The P80AVB and P81AVB are addressable sounder bases with a Visual Alarm Device (VAD) specifically for use with the ZETTLER addressable detectors. The bases are available as fire alarm sounders with Visual Alarm Device in two power outputs, standard and high. The high power option provides more coverage for the VAD compared to standard. Each has an address so they can be monitored and controlled from the fire alarm control panel, which is independent of the detector fitted to the base. The power and communications for the sounder, VAD and detector are provided by the two-wire digital loop. This helps to reduce installation costs as no additional wiring is required.

EN54-23 now provides clarity by standardizing requirements, test methods and performance criteria of Visual Alarm Devices (VADs) and ensures all device parameters are measured in a uniform manner throughout Europe.

Main Requirements from EN54-23 are:

- The coverage volume (i.e. volume within which required illumination is achieved) must be stated on the product or supporting documentation.
- The VAD should meet the requirement for coverage volume of at least one of the following categories: W (Wall), C (Ceiling), O (Open Class).
- Required illumination of 0.4 lux on a surface perpendicular to the direction of the light emitted from the VAD.
- Rate of flash should be stated between 0.5Hz & 2Hz.
- The devices must be classified as Type A, indoor and Type B, outdoor.

Features

- A compact and discrete solution
- VAD approved to EN54-23 with two ranges, standard power and high power available
- High power option provides a larger VAD coverage volume compared to standard
- Reflective Sound Monitoring (RSM)
- Reflective Light Monitoring (RLM)
- Automatic self-test
- Shorter light pulse for faster response
- Optimise the system design for lowest power requirements and lowest cost installation
- Triple light source
- One point of installation for detector, sounder and visual indicator with no additional wiring
- Independent addressable control of the sounder and beacon
- Built-in line isolator
- Select the tone, volume and flash rate using panel configuration software
- 15 selectable tones. Allows users to select the tone with which they are most familiar.
- Realistic conventional bell tone
- 2 selectable volumes
- 2 selectable flash rates
- Different tones can be used for fire alarm and class change
- VADs and sounders are synchronised over the entire loop
- A locking pin supplied with the base which prevents the unauthorized removal of the detector
- Provides an EN54-23 approved upgrade path

Order Codes

- 576.080.006 P80AVB Addressable Base Sounder VAD Standard Power
- 576.080.014 P81AVB Addressable Base Sounder VAD High Power
- 557.080.001 B-CAP Blanking Cap For Sounder /VID / VAD Bases White
- 557.080.002 A-CON Conduit Adaptor For Sounder /VID / VAD Bases White

Technical Information

	P80AVB	P81AVB
Coverage Volume Code:	C-3-8	C-3-15
Devices per Loop:	Up to 86 (*)	Up to 54 (*)
Flash Rate:	0.5 / 1Hz	0.5 / 1Hz
Dimensions (Diameter x H):	135x45mm	135x45mm
Sound Output @ 1m:	Up to 90dBA	Up to 90dBA
Body Colour:	Clear	Clear
Flash Colour:	White	White
IP Code:	IP21C	IP21C
Approvals:	EN54-3, 23, 17	EN54-3, 23, 17

(*) Full intensity VAD with sounder at high volume, 1 A loop.
 Loop quantities are for guidance only and should be verified with the loop calculator.

Wall Category

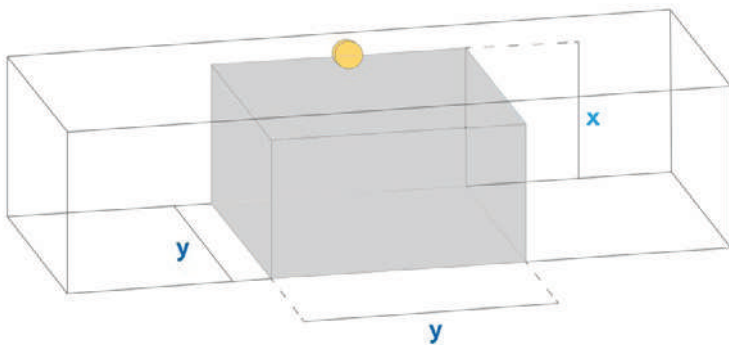

Coverage volume code:

W – (x) - (y)

W = wall mounted

x = maximum mounting height

y = length and width in metres of the cubic volume covered (to a minimum level of 0.4 lux) when the device is mounted to the wall at a height of x

Ceiling Category

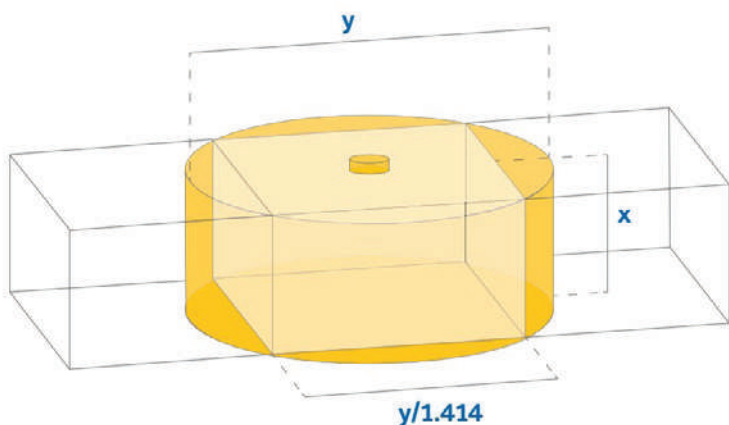

Coverage volume code:

C – (x) - (y)

C = wall mounted

x = maximum mounting height

y = diameter in metres of the cylindrical volume covered (to a minimum level of 0.4 lux) when the device is mounted to the ceiling at a height of x

Open Class Category

The coverage volume and its shape are specified by the manufacturer and include mounting position and orientation alongside any restriction on the mounting height.

3.10

EN-54 Visual Alarm Devices

P80SB & P80AIB Addressable Sounder Base and Addressable Sounder VID Base



Sounders are considered as the most important of all the alarm devices. It is a mandatory requirement that sounders are used as an integral part of the fire detection and alarm system.

VIDs are generally used as a supplementary indication to raise situational awareness. But, when an event occurs, they cannot be used as the only means to alert people to a potential hazard.

The P80SB is an addressable sounder base specifically for use with the ZETTLER addressable detectors. The base incorporates a fire alarm sounder that carries its own address so it can be monitored and controlled from the fire alarm control panel, which is independent of the detector fitted to the base. Both power and communications for the sounder and detector are provided by the two-wire digital loop. This helps to reduce installation costs as no additional wiring is required. Additionally, the P80AIB houses an addressable LED beacon to provide a visual indicator otherwise known as a VID.

EN54-23 now provides clarity by standardizing requirements, test methods and performance criteria of Visual Alarm Devices (VADs) and ensures all device parameters are measured in a uniform manner throughout Europe.

Main Requirements from EN54-23 are:

- The coverage volume (i.e. volume within which required illumination is achieved) must be stated on the product or supporting documentation.
- The VAD should meet the requirement for coverage volume of at least one of the following categories: W (Wall), C (Ceiling), O (Open Class).
- Required illumination of 0.4 lux on a surface perpendicular to the direction of the light emitted from the VAD.
- Rate of flash should be stated between 0.5Hz & 2Hz.
- The devices must be classified as Type A, indoor and Type B, outdoor.

Features

- A compact and discrete solution
- One point of installation for detector, sounder and visual indicator with no additional wiring
- Reflective Sound Monitoring (RSM)
- Light is electronically monitored by the control panel
- Automatic self-test
- Independent addressable control of the sounder and beacon
- Built-in line isolator
- Select the tone, volume and flash rate using panel configuration software
- 15 selectable tones. Allows users to select the tone with which they are most familiar
- Realistic conventional bell tone
- 4 selectable volumes
- 2 selectable flash rates
- Different tones can be used for fire alarm and class change
- VIDs and sounders are synchronised over the entire loop
- A locking pin supplied with the base which prevents the unauthorized removal of the detector
- Replace legacy LPSB3000 and LPAV3000

Order Codes

576.080.002	P80SB Addressable Base Sounder
576.080.010	P80AIB Addressable Base Sounder VID
557.080.001	B-CAP Blanking Cap For Sounder /VID / VAD Bases White

Technical Information

	P80SB	P80AIB
Devices per Loop:	Up to 231 (*)	Up to 149 (**)
Flash Rate:	N/A	0.5 / 1Hz
Dimensions (Diameter x H):	114x45mm	114x45mm
Sound Output @ 1m:	Up to 90dBA	Up to 90dBA
Body Colour:	White	Clear
Flash Colour:	N/A	Red
IP Code:	IP21C	IP21C
Approvals:	EN54-3, 17	EN54-3, 17

(*) Sounder at high volume, 1 A loop.

(**) Beacon at 0.5 Hz with sounder at high volume, 1 A loop.

Loop quantities are for guidance only and should be verified with the loop calculator.

Wall Category

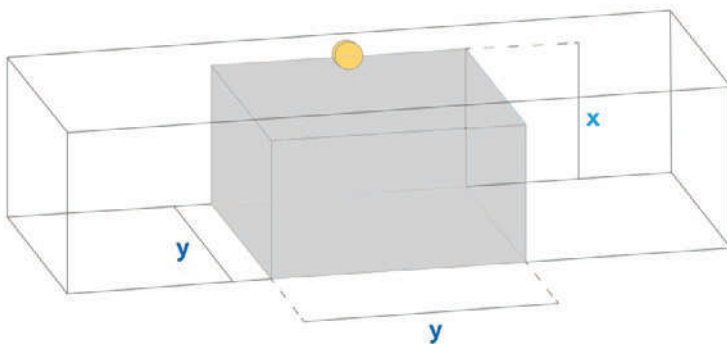

Coverage volume code:

W – (x) - (y)

W = wall mounted

x = maximum mounting height

y = length and width in metres of the cubic volume covered (to a minimum level of 0.4 lux) when the device is mounted to the wall at a height of x

Ceiling Category

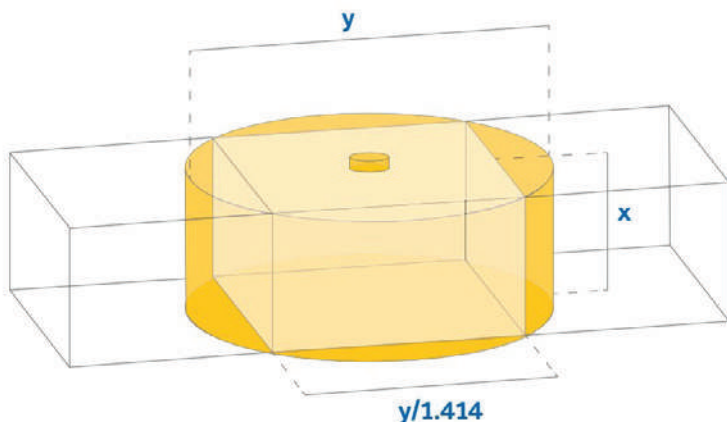

Coverage volume code:

C – (x) - (y)

C = wall mounted

x = maximum mounting height

y = diameter in metres of the cylindrical volume covered (to a minimum level of 0.4 lux) when the device is mounted to the ceiling at a height of x

Open Class Category

The coverage volume and its shape are specified by the manufacturer and include mounting position and orientation alongside any restriction on the mounting height.

3.12

EN-54 Visual Alarm Devices

80DSB Detector Sounder Base Detector Activated Sounder Base



Sounders are considered as the most important of all the alarm devices. It is a mandatory requirement that sounders are used as an integral part of the fire detection and alarm system.

The 80DSB is a detector base specifically for use with the ZETTLER addressable detectors.

The base incorporates a fire alarm sounder that is activated directly by the detector.

EN54-23 now provides clarity by standardizing requirements, test methods and performance criteria of Visual Alarm Devices (VADs) and ensures all device parameters are measured in a uniform manner throughout Europe.

Main Requirements from EN54-23 are:

- The coverage volume (i.e. volume within which required illumination is achieved) must be stated on the product or supporting documentation.
- The VAD should meet the requirement for coverage volume of at least one of the following categories: W (Wall), C (Ceiling), O (Open Class).
- Required illumination of 0.4 lux on a surface perpendicular to the direction of the light emitted from the VAD.
- Rate of flash should be stated between 0.5Hz & 2Hz.
- The devices must be classified as Type A, indoor and Type B, outdoor.

Features

- A compact and discrete solution
- One point of installation for detector and sounder with no additional wiring
- Low power with up to 250 sounders on a single loop
- Provides uncompromised system design solutions
- Simple to select the tone and volume using switches
- No special training or tools needed
- 9 selectable tones
- 4 selectable volumes
- A locking pin supplied with the base which prevents the unauthorized removal of the detector
- Replaces legacy 802SB and it is compatible with 800 series detectors. Can be used for service and repair or as part of a planned upgrade path

Order Codes

- 576.080.001 80DSB Zettler Detector Base Sounder
- 557.080.001 B-CAP Blanking Cap for Sounder / VID / VAD Bases White
- 557.080.002 A-CON Conduit Adaptor for Sounder / VID / VAD Bases White

Technical Information

	P80DSB
Devices per Loop:	Up to 250 (*)
Dimensions (Diameter x H):	114x45mm
Sound Output @ 1m:	Up to 90dBA
Body Colour:	White
IP Code:	IP21C
Approvals:	EN54-3, 17

(*) Sounder at high volume, 1 A loop.
Loop quantities are for guidance only and should be verified with the loop calculator.

Addressable Loop Powered Sounders & Beacons



One Point of Installation – Unique Solution with Huge Savings

Combining a detector base, sounder, beacon and line isolator in one low cost unit will result in a dramatic reduction in the final installation cost. Typically 40% to 55% of the installation costs per point can be saved. This presents an exciting opportunity for sellers. This is achieved without the need for specialist high cost detector heads as standard 830 series MZX detectors are used.

Unique

When used with the 3oTec triple multi-sensor the AV base can provide a completely unique solution combining fire detector, toxic gas detector, isolator, sounder and beacon into a single very cost effective single point of installation.

Reflective Sound Monitoring (RSM) – Patented* Solution significantly reduces Risk

Reflective Sound Monitoring is employed to monitor the audio output of the LPSB3000 and LPBS300 by listening to the output and reporting any sounders that are not working. RSM is a patented* technology and was successfully introduced with the Loop powered Symphoni sounders. It is particularly beneficial during regular weekly sounder tests where users can be satisfied that all their sounders are working, even if the building is not fully occupied at the time of the test. Failure of the beacon would also generate a fault at the control panel.

EN54 Compliant

The addressable loop powered sounder base meets the requirements of EN54 part 3 whilst the loop powered addressable sounder with beacon base is also approved to EN54 part 23 as an open category device.

Features

- High output programmable sounder base and sounder beacon base
- One point of installation for detector, isolator, sounder & beacon
- Loop powered from the MZX Technology® Digital Loop
- High brightness Multi-LED Beacon
- Software programmable
- 15 Tones and 2 Flash Rates
- Integral line isolator
- RSM (Reflective Sound Monitoring)
- Can be used as a standalone device using the sounder blanking cap
- Optional surface mount plastic conduit adaptor
- Visual alarm approved to EN54-23 open category
- Audible alarm approved to EN54-3

Loop Power Capacity

The advanced 3000 series sounders and beacons are independently addressed and are therefore separately controllable from the MZX Digital loop. The maximum number that can be driven from a single loop is dependant on the number of addresses available, the volume selected and the flash rate of the beacon. MXDesigner version 5.0 should be used to accurately determine loop loading and battery size. Typically, at full volume of 90dB, 50 x LPBS3000 sounders or 30 x LPAV3000 sounder beacons at 0.5Hz flash rate can be driven by a single 1Km loop. That gives a typical maximum of 240 sounder beacons at full volume from a single 8 loop panel.

Built-in Isolation

As the line isolator is now integral to the device the need for separate line isolation devices is reduced.

Tones

15 Tones are available from the sounder, which include tones compatible with the LP Symphoni range, 802SB sounder base and the LPBB520 (loop powered Besson Banshee). 4 sound levels 60dB to 90dB (± 3 dB) and 2 flash rates 1/2Hz & 1Hz are available.

MZX Consys

The AV base range of devices are fully supported by Consys Version 14 and later, the point input dialog box provides an easy method for setting the Tones, Volume and Flash rate of the device. The only operation required at the device is to set the address using the 850EMT device programmer.

3.14

Loop Powered Sounders

Technical Information

System:	For use with MZX fire alarm controllers
Operating Temp:	-20°C to +70°C
Storage Temp:	-25°C to +70°C
Relative Humidity:	Up to 95% RH (non condensing) IP Rating 21 C EN60529
Dimensions:	102mm dia x 42mm high
Weight:	LPSB3000 0.160kg LPBS3000 Loop Powered Beacon-Sounder Base 0.170Kg
Materials:	Housing ABS FR & Polycarbonate
EMC:	The range complies with the following: Product family standard EN50130-4 in respect of conducted disturbances, radiated immunity, electrostatic discharge, fast transients and slow high energy EN61000-6-3 for emissions

Order Codes

516.800.969	LPBS3000 Loop Powered Beacon-Sounder Base
516.800.959	DAB3-4 Mounting flange – type B for conduit (supplied in packs of 10)

Note: Detectors supplied separately

Loop Powered Symphoni Sounders and Sounder Beacons



Models Available

The Sounder only models are available with a red or white housing suitable for indoor use and an IP65 rated red housing for outdoor applications.

The Audio /Visual models, which incorporate a highly efficient white LED beacon, are also available with a red or white housing for indoor use and an IP65 rated red housing for outdoor applications.

Reflective Sound Monitoring

The LP Symphoni utilising Reflective Sound Monitoring (RSM) employs a transducer to actively monitor the units' sound output during the weekly sounder test and will report back to the control panel if it fails to detect the sounder operating when it has been commanded to, this ensures that the LP Symphoni range of sounders will in the unlikely event of a fault, display it immediately on the fire controller and is therefore not dependant upon the staff within a building reporting a sounder failure.

Built-in Isolation

As the line Isolator is now integral to the device the need for separate line isolation devices is reduced.

Tones

16 Tones are available from the sounder, which include tones compatible with the 802SB sounder base and the LPBB520 (loop powered Besson Banshee). Dutch slow whoop and the DIN 1Hz sweep are included. Two sound levels 103dB & 90dB (± 3 dB).

EN54 Compliant

The addressable loop powered sounder meets the requirements of EN54 part 3 whilst the loop powered addressable sounder with beacon is also approved to EN54 part 23 as an open category device.

Features

- Loop Powered – Reduced installation costs
- High Output/Low consumption – Lower lifetime costs
- Indoor and Outdoor models – Same sounder tones in all areas
- Sounder/LED Beacon Version
- 16 Tones and 2 Flash rates – Suits individual requirements
- Reflective Sound Monitoring RSM - Reassurance that ALL sounders are working
- Integral Line Isolator – Saves cost and installation time
- Visual alarm approved to EN54-23 open category
- Audible alarm approved to EN54-3

Technical Information

Operating Temp	
Indoor devices:	-10°C to +55°C
Outdoor devices:	-20°C to +70°C
IP rating	
Indoor devices:	IP21C
Outdoor devices:	IP65
EMC:	Product family standard EN50130-4 in respect of Conducted Disturbances, Radiated Immunity, Electrostatic Discharge, Fast Transients and Slow High Energy EN61000-6-3 for Emissions

Order Codes

516.800.962	LPSY865 Symphoni IP65 addressable sounder IP65 red body outdoor use
516.800.968	LPBS865 Open class Symphoni addressable beacon sounder IP65 red body white flash outdoor use

3.16

Bells

6" & 8" Motorised Bells



Model	MBF-6EV	MBF-8EV	MBA-8EV
Rated Voltage:	24 Vdc	24 Vdc	24 Vdc
Rated Current:	11 mA	17 mA	18 mA
Sound Output:	90-95dBA	90-97dBA	91-97dBA
Operating Temp:	-12 to +50°C		-10 to +50°C
Colour:	Red		
Weight:	410g	640g	1100g with Backbox

Features

- CE marked
- Low current 6" bell (ONLY 11 mA)
- Low cost
- Extra high 95dBA/m
- Slim profile (53 mm)
- Fully suppressed and polarised
- Quick and easy to install
- LPCB approved to EN54 Pt 3

Order Codes

576.501.039.A	MBF-6EV ADT Branded
576.501.039.T	MBF-6EV Thorn Branded
576.501.040.A	MBF-8EV ADT Branded
576.501.044.A	MBA-8EV ADT Branded
576.501.044.T	MBA-8EV Thorn Branded
576.501.045	BBX4 (2) W/P Backbox for MBA-8 Bell

Electronic Solenoid Bell



Unique patented alarm bell with miniature solenoid and integrated electronic control. No backbox required for surface wiring.

Features

- Weatherproof Option
- Flexible Mounting Option
- Attractive Design

Technical Information

Dimensions:	6" diameter
Voltage:	18-30 Vdc
Typical Current:	30 mA @ 24Vdc
Typ. Sound Output:	94dB (A) @ 1m

Order Codes

20-100	6" 24 Vdc Electronic bell, weatherproof IP33C - Wormald Branded
20-101	6" 24 Vdc Electronic bell - red IP21C - Wormald Branded
20-111	6" 24 Vdc Electronic bell - white IP21C

Marine Approved Products

576.501.407	MED 6" 24 Vdc Electronic bell, weatherproof - red IP33C
576.501.408	MED 6" 24 Vdc Electronic bell - red IP21C

CF Motorised Bell



The CF Motorised Bell is low current, fully suppressed and polarised.

Features

- Low Current Consumption
- Suppressed and Polarised
- Sturdy Construction

Technical Information

Colour:	Red
Output Voltage:	20-28Vdc
Typical Current:	25mA @ 24Vdc
Typ. Sound Output:	95dB (A) @ 1m

Order Codes

Marine Approved Products

576.501.405	MED 6" Red 24Vdc Motorised bell, "Fire" text with Thorn Branding
-------------	--

3.18

Electronic Sounders

Banshee Excel Sounders & Excel Lite Sounder Beacons



Banshee Excel Sounders

The Banshee Excel sounder replaces the Banshee Multi Tone range of Sounders. It uses the same technically superior rocking arm transducer to reproduce the familiar 32 tones of the previous Banshee and Bedlam ranges.

Banshee Excel Lite Sounder Beacon

The Banshee Excel adds the Banshee Excel Lite Sounder Beacon to its range using a high output xenon with the familiar sounder. The Banshee Excel Lite can be used as a multi stage device by switching the beacon and the sounder independently using a third wire.

Banshee Sounder Accessories

The combined mounting bracket for the Besson Multi-tone Banshee and Xenon Beacon allows quick and neat installation of combined sounders and beacons. The bracket allows the following electronic sounders to be mounted with the range of 1W Xenon Beacons:

- Besson Banshee
- FIRECRYER voice enhanced sounder



The bracket can be used with any of the 24Vdc 1W Xenon beacons in red, clear, amber or blue (Part no.'s LPB24-C-T/LPB24-B-T/LPB24-A-T & LPB24-R-T)

Features

- Modern aesthetic design
- 32 Selectable tones
- 3 Volume settings
- Push and twist mount
- Shallow and deep bases
- Available in red or white
- Low current consumption
- 2 Stage alarm available
- Independently switched sounder or beacon
- Xenon beacon with the Excel Lite

Technical Information

Approvals:	VdS approved to EN54-3
Tones Available:	32
Operating Voltage:	9-30 Vdc
Tone Current Consumption:	See Tone Table on the next page
Flash Current Consumption:	4 0 mA
Operating Temp:	-40 to +70°C
Volume Control via DIL Switch:	Maximum, Medium (-10dBA), Low (-20dBA)
Flash Rate per Sec:	1
Ingress Protection:	IP45 or IP66
Termination:	Screw terminals for 028 mm ² to 2.5 mm ² wire conductor

Order Codes

576.501.060	Banshee Excel sounder, red, IP45 (replaces 576.501.005.A & 576.501.005.T)
576.501.061	Banshee Excel sounder, white, IP45 (replaces 576.501.009 & 576.501.025.A)
576.501.062	Banshee Excel sounder, red, IP66 (replaces 576.501.016.A & 576.501.016.T)
576.501.063	Banshee Excel Lite, red sounder, red xenon beacon, IP45

Sounder Accessories

576.501.047	Banshee/Xenon bracket
-------------	-----------------------

Banshee Excel Tone Table

No.	DIL Sw 12345	Description	Frequency and Timing	2nd Tone	Banshee Excel				Banshee Excel Lite			
					12V		24V		12V		24V	
					dBa	mA	dBa	mA	dBa	mA	dBa	mA
1	00000	Banshee Buzz LF	800Hz to 950Hz swept at 120Hz	4	94	6	101	12	94	6	100	12
2	10000	Banshee Fast Sweep LF *	800Hz to 950Hz swept at 9Hz	4	94	6	101	12	94	6	100	12
3	01000	Banshee Slow Sweep LF	800Hz to 950Hz swept at 3Hz	4	94	6	101	12	94	6	100	12
4	11000	Banshee Continuous LF	Continuous at 900Hz	4	94	6	101	12	94	6	100	12
5	00100	Banshee Fast Sweep LF (New)	830Hz to 970Hz swept at 9Hz	4	95	6	101	12	93	6	100	12
6	10100	Medium Sweep LF *	830Hz to 970Hz swept at 1Hz	7	96	6	101	12	94	6	100	12
7	01100	Continuous LF	Continuous at 950Hz	7	96	6	102	13	94	6	100	12
8	11100	Backup Alarm LF	Intermittant at 950Hz - 1 sec on / 1 sec off	4	96	6	102	14	93	6	99	14
9	00010	Alternate LF	Alternating 800Hz/1000Hz at 1Hz	4	94	6	100	13	94	6	100	13
10	10010	Medium Sweep LF	800Hz to 1000Hz swept at 0.5 secs	4	95	6	101	12	94	6	100	12
11	01010	Alternate LF	Alternating Tones 800/950 at 3Hz	4	96	6	101	12	94	6	101	12
12	11010	Banshee Buzz HF	2400Hz to 2900Hz at 120Hz	15	102	16	110	35	102	16	109	35
13	00110	Banshee Fast Sweep HF	2400Hz to 2900Hz at 9Hz	15	103	17	110	35	103	17	110	35
14	10110	Banshee Slow Sweep HF	2400Hz to 2900Hz at 3Hz	15	103	17	110	35	103	17	110	35
15	01110	Banshee Continuous HF	Continuous 2900Hz *	15	103	19	110	39	103	19	109	39
16	11110	Banshee Fast Sweep HF (New)	2450Hz to 3100Hz swept at 9Hz	15	103	18	110	36	103	18	109	36
17	00001	Backup Alarm HF	Intermittant at 2900Hz - 1 sec on / 1 sec off	15	104	18	110	36	103	18	109	37
18	10001	Alternate HF	Alternating Tones 2400/2900 at 3Hz	15	104	16	110	36	104	17	110	36
19	01001	Slow Whoop *	500Hz rising to 1200Hz over 3.5 secs / silence 0.5 sec	4	95	6	101	12	95	6	101	12
20	11001	Din Tone (DK) *	1200Hz falling to 500Hz over 1 sec / silence 10 secs / repeat	4	93	5	110	10	93	5	100	12
21	00101	French Fire Sound *	554Hz for 100ms and 440Hz for 400ms	4	90	4	96	7	90	4	96	7
22	10101	Australian Alert Signal	420Hz repeating - 0.625 sec on / 0.625 sec off	4	89	3	95	6	89	3	94	6
23	01101	Australian Evacuation Signal	500Hz to 1200Hz sweeping - 3.75 secs on / 0.25 secs off	4	95	6	103	12	95	6	101	12
24	11101	US Temporal Tone LF	950Hz - 0.5 sec on / 0.5 sec off for 3 phases, silence for 1.5 secs then repeat	4	95	5	101	10	93	5	99	10
25	00011	US Temporal Tone HF	2900Hz - 0.5 sec on / 0.5 sec off for 3 phases, silence for 1.5 secs then repeat	15	104	13	110	26	103	13	109	27
26	10011	Swedish Tone (Fire)	Intermittant 660Hz - 150ms on / 150ms off	26	90	3	96	6	90	3	96	6
27	01011	Swedish Tone (All Clear)	Continuous 660Hz	27	91	5	97	9	91	5	97	9
28	11011	ISO8201 LF	Intermittant 970Hz - 500ms on / 500ms off	28	93	5	99	10	90	5	96	10
29	00111	ISO8201 HF	Intermittant 2900Hz - 500ms on / 500ms off	29	103	13	110	27	103	13	109	27
30	10111	BT Banshee (FP1063.1)	Yodel 800Hz/1000Hz - 0.25 sec each frequency	31	93	6	100	12	94	6	100	12
31	01111	BT Banshee (FP1063.1)	Continuous 1000Hz	31	90	6	96	14	88	6	94	14
32	11111	Bell Tone	Bell Tone	32	96	12	101	25	94	12	99	25

3.20

Electronic Sounders

Yodalarm

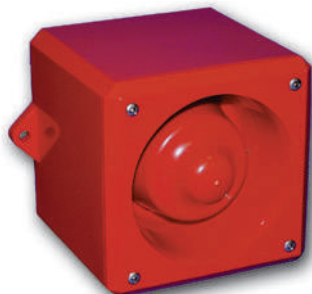

This versatile range of sounders are ideally suited for fire, safety and security hazard warning.

Technical Information

YO3:	89H x 89W x 85D mm
YO5:	134H x 134W x 128D mm
YO8:	216H x 216W x 153D mm
Approvals:	EN54-3:2001+A1:2002 + A2 :2006 Vds 2504 (12/96), Vds 2203 (03/01), Vds 2344 (12/05), Cert No. G28702 Marine Equipment Directive MED Module B BSI/MED/A. 1/3.53/590299, Module D BSI/MED/PC/590302

Order Codes

YA30/D/RF/WR	Sounder YA30 100 dB 24 VDC IP65
YA50/D/RF/WR	Sounder YA50 110dB 24 VDC IP65
YA80/D/RF/WR	Sounder YA80 115dB 24 VDC IP65

24Vdc Symphoni Sounder



The 24 Vdc Symphoni Sounder is a general purpose internal sounder, available either as a very high output sounder for noisy areas, or a high output low current sounder for applications where power is limited. Both versions share the same horn and backbox which has double cable entries for ease of installation.

Order Codes

576.501.200	SY/R Low Power Red Symphoni Sounder (3 tone)
576.501.201	SY/W Low Power White Symphoni Sounder (3 tone)
576.501.202	SYHO/R High Output Red Symphoni Sounder (32 tone)
576.501.203	SYHO/W High Output White Symphoni Sounder (32 tone)

The low power version has 3 selectable tones which may be employed for one, two or three stage alarm applications. The high output version has 32 selectable tones and retains full tone compatibility with the Roshni, Squashni and Askari product ranges.

Model	Symphoni High Output	Symphoni (Low Power)
Operation:	2 Hours Continuous	Continuous
Operating Voltage Range:	9-28 Vdc	12-30 Vdc
Sound Output @ 1 m:	Up to 120dB(A)	100dB(A) +/- 2dB(A) @24 Vdc
Volume Control:	-	Down to 80dB approx
Current Consumption:	240 mA +/- 20 mA on Tone 3	5mA +/- 1 mA at all volumes
Tones:	1 to 32	Alternating 990Hz/650Hz@2Hz / Continuous 990Hz / Intermittent 990Hz, On/Off@1Hz
Synchronisation:	Synchronised Start	Synchronised Start
Frequency Stability:	+/- 0.15%	+/- 0.5%
Operating Temperature:	-25°C to +55°C	-25°C to +70°C
Line Monitoring Method:	Polarised Input	Polarised Input
Construction:	ABS Plastic Case	ABS Plastic Case
Ingress Protection:	IP21C	IP21C
Weight:	0.58Kg	0.212 Kg

Roshni Sounders



A flexible alarm sounder for Fire and Security applications complete with volume control and dil switch to provide 32 tones.

Low profile Roshni with Deep base offers IP65 protection. All Roshni sounders have synchronised start for self synchronisation without third wire.

Technical Information

Dimensions:	93 Dia x 105D mm (Deep base)
Colour:	Red or white
Output Voltage:	9-28 Vdc
Typical Current:	16mA @ 24Vdc
Typ. Sound Output:	102dB @ 1m

Order Codes

ROSHRDSR	ROSHNI Red Sounder c/w deep base
576.501.220	ROSHNI Red Sounder c/w shallow base
576.501.221	ROSHNI White Sounder c/w shallow base
576.501.222	ROSHNI/Flashni Red c/w deep base
576.501.223	ROSHNI/Flashni White c/w deep base

Squashni Sounders (Conventional Only)



The Squashni sounder is the original ceiling sounder for use as a universal fire detector platform or as a stand-alone sounder complete with blank cover. It comes preset to tone 3 with a volume control, is fully compatible with Roshni tones and has a synchronised start.

Technical Information

Dimensions:	112 Dia x 27D mm
Colour:	Matched to leading fire detector manufacturers
Approvals:	None
Output Voltage:	9-28 Vdc
Typical Current:	24 Vdc @ 16 mA
Typ. Sound Output:	93dB (A) @ 1 m

Order Codes

576.501.030	Squashni white 24Vdc
576.501.031	Blank cover plate white for Squashni

Multi-Tone Askari Compact (Conventional Only)



The Multi-Tone Askari Compact is a compact bedroom sounder for unobtrusive installation. It comes with a volume control, is fully compatible with Roshni tones and has a synchronised start. A surface mount backbox is available from the supplier to special order.

Technical Information

Dimensions:	87.5H x 87.5W x 36D mm
Colour:	Red or white
Approvals:	BS5839 pt 1
Input Voltage:	9-28 Vdc
Typ. Current:	18 mA @ 24Vdc
Typ. Sound Output:	97dB (A) @ 1m

Order Codes

576.501.242	White Multi Tone Askari Compact Sounder
576.501.243	Red Multi Tone Askari Compact Sounder

3.22

Intrinsically Safe Electronic Sounders

Banshee IS28 MK6 Intrinsically Safe Sounder



Features

- Based on the world class Hosiden Besson Banshee Sounder
- Gas and Dust Approvals
- 32 Tones
- Volume control via DIP Switch
- High output
- Low current consumption
- IP66 rated

With 32 high and low frequency tones to suit a wide range of applications.

ATEX and IECEx approved for use in Zones 0 and 20 (Gas and Dust) and is suitable for use in zones 1, 2, 21 and 22.

The product should only be connected to the monitored driving circuit via an certified galvanic isolator or zener barrier.

Suitable for all non-mining applications.

Order Code

576.501.053 IS28 Mark 6 Banshee Sounder

Technical Information

Power Supply:	24 Vdc
Typical Current:	15mA (high frequency tones), 11mA (low frequency tones) @24Vdc via a 28V 300Ω barrier)
Output @ 1m:	98 dBA (high frequency) 90 dBA (low frequency)
Installation:	Connection must be made via a certified galvanic isolator or zener barrier with output parameters not exceeding $U = 28V$, $I_i = 93mA$, $P_i = 0.65W$, $L_i = 0$, $C_i = 0$. The output current of the barrier must be limited by resistor 'R' such that $I_i = U_i/R$.
Suitable for Zones:	0, 1, 2, 20, 21 and 22
Operating Temp:	-40 to +70°C
IP Rating / Material:	IP66 / ABS (When installed with Fixing Clip)
Weight:	262g

Intrinsic Safety Approvals:	EN 60079-0:2012 + A11:2013, General Requirements EN 60079-11:2011, Intrinsic Safety 'i' Group II, Category I, Explosive Atmosphere G (Gas) and D (Dust) IECEX ITS17.0011X ATEX ITS 17ATEX201739X Ex ia IIC T5 Ga Ex ia IIIC T100degC Da IP66 ATEX - II IGD Ex ia T5 Ga
-----------------------------	---

Fire-Cryer Plus® Voice-Enhanced Sounders



The Fire-Cryer® Plus range of voice sounders are electronic sounders which are pre-programmed with 9 messages. Each of the Fire-Cryer® voice sounders can be used as a single message voice sander by simply installing them on to a conventional 24 Vdc sander circuit or by using a sander controller on a loop. The choice of message(s) broadcast can be selected using a DIL switch on the rear of the sander. **See Table A later in this section.**

The Fire-Cryer® Plus offers an excellent service upgrade opportunity for systems as well as a highly flexible and cost effective solution to providing a voice evacuation system to many buildings. The choice of Fire-Cryer® voice sounders can be selected using **Table B**

Messages 1 to 7 in **Table A** can be used in a multi message installation with the addition of a Multi Message Switching PCB (576.501.171) or a Voice Message Controller (576.501.181 or 576.501.182) interfaced between the fire alarm control panel and the sander circuits.



Features

- Single Message or Multiple Message using the same sander
- Multi Message facilitates multi evacuation strategies
- Clear and unambiguous alarm messages
- Voice Alarm Messages provoke an immediate response
- Sound Output – Up to 100db(A) (Fire-Cryer® Plus), 90db(A) (Mini Fire-Cryer® Plus), 110db(A) (Midi Fire-Cryer® Plus)
- Optional integral Red Strobe
- Low current consumption – average 20 mA
- No special wiring easily retro fitted
- Fully synchronised over multi zones
- Deep base version available to IP66
- Ultra slim base sander to fit industry standard detectors
- Suitable for ceiling or wall mounting (Mini Fire-Cryer® Plus)
- Optional front plate for stand alone use (Mini Fire-Cryer® Plus)
- Voice Message Controller makes manual message switching easy

The Voice Message Controllers can be supplied with a 2.5 A or 5.25 A power supply built in. A Zone Extension PCB (576.501.172) is available to extend the system to 4 zones or 8 sander circuits. See **Table C**

A special Extinguishing PCB (576.501.173) used with the 576.501.135 will enable 1st, 2nd Stage, 'Hold' and 'Gas Released' messages to be automatically broadcast dependent on the state of the alarm. **See Table A1**





Fire-Cryer Plus® Components

	Description	Order Codes
	Fire-Cryer® Plus Multi Message PCB	576.501.171
	Fire-Cryer® Plus Zone Extension PCB	576.501.172

3.24

Electronic Voice-Enhanced Sounders

Fire-Cryer Plus® Components (Continued)

	Description	Order Codes
	Fire-Cryer® Plus Extinguishing PCB	576.501.173
	Din Rail Mounting Kit	557.201.303
	IP66 Housing	557.201.410
	VMC / Multi Message PCB and 2.5 A PSU	576.501.181
	VMC / Multi Message / Zone Extension PCB and 5.25 A PSU	576.501.182

Technical Information

Fire-Cryer® Plus Model	Fire-Cryer® Plus	Mini	Midi
VDC Operating Voltage:	20-28	20-28	20-28
Current mA @ 24VDC Peak/Avg - Sounder only:	27/20	27/20	180/100
Current mA @ 24VDC Typical - Sounder with low current strobe:	33/26	N/A	N/A
Current mA @ 24VDC Typical - Sounder with high current strobe:	52/60	N/A	N/A
Current mA @ 24VDC Low current strobe only:	13	N/A	N/A
Current mA @ 24VDC High current strobe only:	32	N/A	N/A
Strobe Output Cd (LOW):	2	N/A	N/A
Strobe Output Cd (HIGH):	6	N/A	N/A
Volume Adjustment from Max. dBA Output to max output -18dBA:	82 to 100	72 to 90	101 to 110
Weatherproofing (IP66 requires Deep Base):	IP45 or IP66	N/A	IP44
Housing Material:	ABS	ABS	Aluminium/ Plastic Base
Temperature Range:	-25 to +70°C	-10 to +55°C	-25 to +70°C
Colour:	Red or White	White	Red
Connections:	Screw TB 1.5mm ²	Screw TB 1.5mm ²	Clamp 2.5mm ²

System Schematics

Figure 1 - Direct Connection to FACP

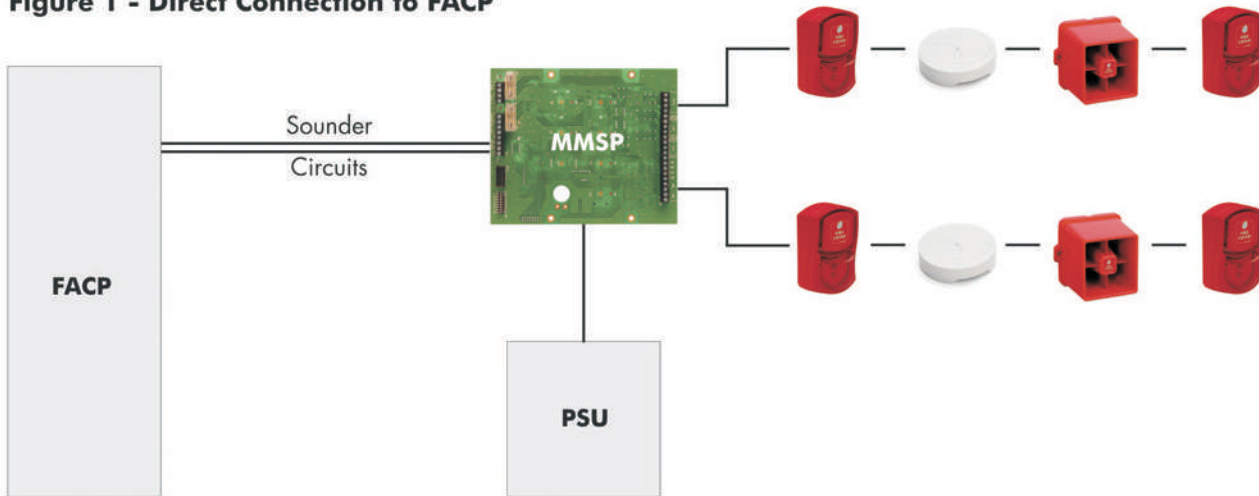
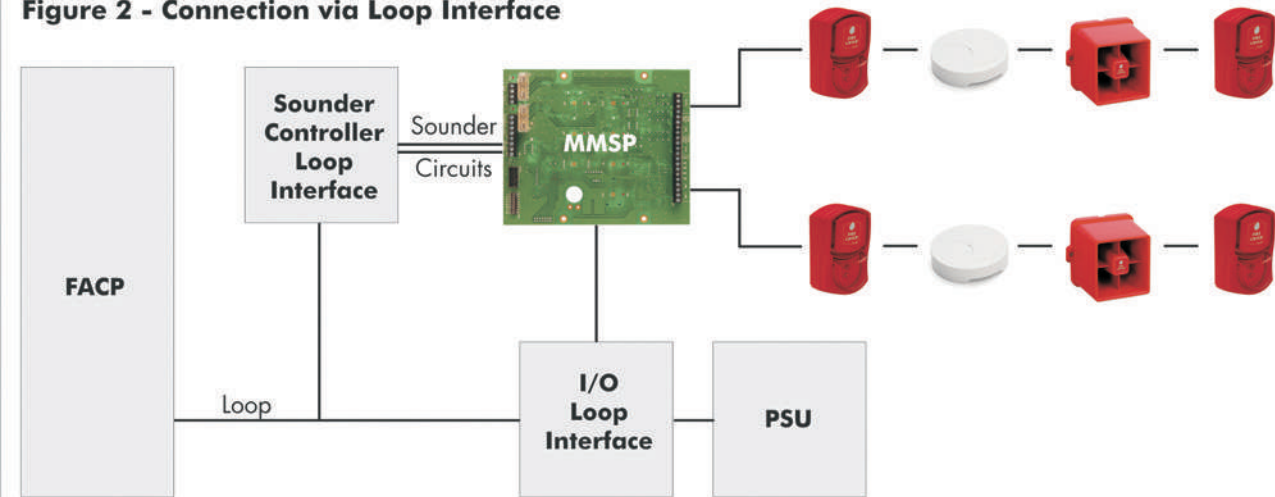

Figure 2 - Connection via Loop Interface



3.26

Electronic Voice-Enhanced Sounders

Standard Message Set which consists of 9 pre-programmed messages with tones (See Table A)

TABLE A

When used as a multi-message sounder DIL Switches 4, 5, 6, 7 and 8 are OFF. When used as a single message sounder use the DIL Switch settings in the table below 1 = ON, 0 = OFF

When used as a Multi Message Sounder the Multi Message Switching PCB (576.501.171) will assign the messages to the following triggers:

	Starting Tone (See Table A2 below)	Two Letter Message Code	Beacon Flashes (Y/N)	Speech Message	↓	SW4	SW5	SW6	SW7	SW8
Message 1	1	AK	Y	Fire emergency. Please remain calm and evacuate the building immediately.	S1A/S1B	1	0	0	0	0
Message 2	2	AB	Y	This is a fire alert. This is a fire alert. Await further instructions. Await further instructions.	MA	0	1	0	0	0
Message 3	2	MA	Y	Standby alert. Close all blinds and move to the middle of the room.	MB	1	1	0	0	0
Message 4	0	AD	N	All clear. All clear. No further action required.	MC	0	0	1	0	0
Message 5	0	SP	N	This is an ADT fire test. No action required.	MD	1	0	1	0	0
Message 6	3	CC	N	This is a class change announcement.	ME	0	1	1	0	0
Message 7	1	AF	Y	Fire detected. Keep calm. Leave the building by the nearest exit.	MF	1	1	1	0	0
Message 8	2	AX	Y	Ladies and gentlemen – due to unforeseen circumstances we must ask you to leave the building immediately by the nearest exit or as directed by members of staff.		0	0	0	1	0
Message 9	2	AZ	Y	We have an emergency situation. Please leave the building by the nearest exit. Members of staff will assist you.		1	0	0	1	0

TABLE A1

Gas Extinguishant Messages (Used with 576.501.135)

	Starting Tone (See Table A2 below)	Two Letter Message Code	Beacon Flashes (Y/N)	Speech Message
1st Stage	2	CG	Y	First stage extinguishant release warning.
2nd Stage	2	CH	Y	Second stage extinguishant release warning.
Hold	0	LU	N	Extinguishant gas release on hold.
Gas Released	1	CJ	Y	Extinguishant released.

TABLE A2

Tone	
0	No tone
1	Banshee LF Fast Sweep. 800Hz to 950Hz swept @ 9hz
2	Banshee LF Fast Sweep. 800Hz to 950Hz swept @ 9hz Pulsed at 1 second ON, 1 second OFF
3	Bell tone, pulsed

Ordering Fire-Cryer: Step 1 - Choose your Fire-Cryer Plus® Sounder

TABLE B	Type	Body Colour	Beacon	Base	Order Code
	Wall Mount	Red	Red	Shallow	576.501.131
				Deep	576.501.132
			None	Shallow	576.501.133
				Deep	576.501.134
	Wall Mount	White	Red	Shallow	576.501.141
			None	Shallow	576.501.142
	Wall Mount	Red	Red	Shallow	576.501.135
	Wall Mount	Red	None	Deep	576.501.151
	Base Mount	White	None	N/A	576.501.161

Ordering Fire-Cryer: Step 2 - Choose your Interfaces for Multi Message Systems

TABLE C

Standard Multi Message Switching PCB					576.501.171
Zone Extension PCB (adds 3 Zones of 2 Sounder Circuits i.e. 6 sounder circuits. Must be used with 576.501.171)					576.501.172
Extinguishant Interface PCB					576.501.173
Voice Message Controllers & PSUs (All VMC enclosures include a 576.501.171)					
576.501.171	576.501.172	PSU	Box Size	Part Ref	
Yes	No	2.5 A	M2	576.501.181	
Yes	Yes	5.25 A	M3	576.501.182	
Box Sizes	M2 Enclosure 385W x 310H x 90D mm				
	M3 Enclosure 385W x 520H x 90D mm				

Order Codes

576.501.131	Standard Fire-Cryer® Plus, red wall mounted, shallow base, red beacon
576.501.132	Standard Fire-Cryer® Plus, red wall mounted, deep base, red beacon
576.501.133	Standard Fire-Cryer® Plus, red, wall mounted, shallow base
576.501.134	Standard Fire-Cryer® Plus, red, wall mounted, deep base
576.501.135	Standard Fire-Cryer® Plus (for use with 576.501.173 in Gas Extinguishant systems)
576.501.141	Standard Fire-Cryer® Plus, white wall mounted, shallow base, red beacon
576.501.142	Standard Fire-Cryer® Plus, white, wall mounted, shallow base
576.501.151	Midi Fire-Cryer® Plus, c/w back box, red
576.501.161	Mini Fire-Cryer® Plus, base mounted, white, c/w cover
576.501.052	Mini Fire-Cryer® Plus, voice enhanced base sounder cable spacing ring
576.501.171	Fire-Cryer® Plus Multi Message PCB
576.501.172	Fire-Cryer® Plus Zone Extension PCB
576.501.173	Fire-Cryer® Plus Extinguishing PCB
557.201.303	Din Rail Mounting Kit for Fire-Cryer® Plus Extinguishing PCB
557.201.410	IP66 Housing for Fire-Cryer® Plus Extinguishing PCB
576.501.181	Voice Message Controller c/w Multi Message PCB and 2.5 A PSU
576.501.182	Voice Message Controller c/w Multi Message PCB, Zone Extension PCB and 5.25 A PSU
576.501.191	Fire-Cryer® Plus Demo Unit

Please Note: The beacon in this product should be used for supplementary indication purposes only. In this case the device is not required to be used as a Visual Alarm Device (VAD) and EN54-23 is not relevant to its classification.

3.28

EN-54 Beacons

Symphoni / Solista EN54-23 Beacons



Each of these applications will be required to use visual alarm devices that comply with EN 54 – 23. The standard does not apply to visual indicators such as remote LEDs or to supplementary visual alarms that are not considered part of the primary alarm system.

The standard covers planning, design, installation, commissioning and service and is intended to ensure that visual alarms are sufficiently bright to be effective as a primary means of alarm. To achieve this, the standard stipulates a minimum light level of 0.4lux on any surface, and manufacturers must specify the room size their product will cover with this level of illumination.

Features

- A new harmonised standard became mandatory from December 31st 2013 which is EN54-23:2010.
- This standard is for all visual alarm devices (beacons) used on a fire system. There are several reasons for providing visual alarms for fire alarm systems, including:
 - To alert people with a hearing loss
 - Noisy areas where occupants are wearing ear defenders
 - For staff alarms
 - For use in broadcasting studios
 - Areas such as hospital operating theatres
 - Stage one visual alarms for extinguishing systems

Order Codes

- | | |
|------------------|--|
| 812007FULL-0108X | Solista LX wall beacon (Red body, white flash, shallow base)
EN54-23 W-2.4 7.5 |
| 812008FULL-0109X | Solista LX wall beacon (Red body, white flash, deep base)
EN54-23 W-2.4 7.5 |
| 812020FULL-0121X | Solista LX ceiling beacon (White body, white flash, shallow base)
EN54-23 C-3-7.5 |
| 500023FULL-0023X | RoLP LX wall beacon (Red body, white flash, rolp base)
EN54-23 W-2.4 7.5 (Use with RoLP sounder) |
| 500043FULL-0043X | Symphoni G1 LX wall beacon (Red body, white flash, symphoni)
indoor base EN54-23 W-2.4 7.5 |
| 500048FULL-0048X | Symphoni G1 LX wall weatherproof beacon (Red body, white flash, symphoni outdoor base) EN54-23 W-2.4 7.5 |

Single Gang Lamp/Buzzer Units



Lamp Buzzer units may be used for local alarms when high level audible warnings may not be appropriate. Available in flush and surface mount versions to fit standard single gang backboxes.

Features

- Low Current
- Flush or Surface Mount
- Hi-Brightness LED

Technical Information

Dimensions: 90H x 90W x 40D mm
Current Rating: 15 mA @ 24 Vdc nominally

Order Codes

540.011.012	Single gang flush mount LED (red)/ Buzzer Unit labelled 'Fire Alarm'
540.011.013	Single gang surface mount LED (red)/ Buzzer Unit labelled 'Fire Alarm' c/w surface backbox

Solista LED Beacon



Ultra low power requirement 3mA or 6mA at 24Vdc.
Long life low profile design. Protected to IP54, supplied complete with base.

Order Code

576.501.230 Solista LED Beacon (Red)

Please Note:

This beacon should be used for supplementary indication purposes only. In this case the device is not required to be used as a Visual Alarm Device (VAD) and EN54-23 is not relevant to its classification.

Easy AV™ Retrofit LED Beacon



Order Code

576.501.012 Easy AV strobe for Banshee Sounders

Please Note:

This beacon should be used for supplementary indication purposes only. In this case the device is not required to be used as a Visual Alarm Device (VAD) and EN54-23 is not relevant to its classification.

This low power LED beacon is designed to be retrofitted to existing Banshee electronic sounders. Easy and fast installation typically 3 min. Low power 6 mA max at 24 Vdc High Output LEDs.

3.30

Beacons

Single Gang Lamp/Buzzer Units



A range of cost effective, low profile, high efficiency LED beacons with a variety of lens colour options. They are designed for use as visual indicator devices (VID).

Technical Information

Rated Voltage:	12 Vdc / 24 Vdc
Current	80 mA - 12 Vdc
Consumption:	30 mA - 24 Vdc
Operating Temp:	-10 to 50°C
Dimensions:	73mm Dia x 44H mm
Material (Base):	ABS
Material (Lens):	Acrylic / Polycarbonate
Colour (Base):	Black
Colour (Lens):	Amber, Blue, Clear and Red

Features

- Uses efficient LED technology
- Low profile design (44 mm)
- Twin thread mount
- Low current operation
- Maximum light intensity and dispersion
- Compatible with a wide range of systems
- IP66 rated
- Fresnel Lens
- Polycarbonate and ABS construction
- Choice of coloured lenses: Amber, Blue, Clear or Red
- Suitable for fire alarm VID applications

Order Codes

LPB24-C-T	24 Vdc LED Strobe Clear lens
LPB24-B-T	24 Vdc LED Strobe Blue lens
LPB24-A-T	24 Vdc LED Strobe Amber lens
LPB24-R-T	24 Vdc LED Strobe Red lens

Please Note:

These beacons should be used for supplementary indication purposes only. In this case the device is not required to be used as a Visual Alarm Device (VAD) and EN54-23 is not relevant to its classification.

Voltage Vdc	Power Output Watts	Alarm Current mA	Flash Rate	Rating	Temp. Range	Dimensions (mm)	
						Height	Diameter
24	1	42	60/min	IP65	-30 to +70°C	51	75
24	2	84	60/min	IP65	-30 to +70°C	51	75
24	3	126	60/min	IP65	-30 to +70°C	51	75



Special Detection

Beam Detection
Aspirating Smoke Detection
Linear Heat Detection

4.02

Special Detection

Special Detection

Beam Detection

Specialist detection systems are sometimes the preferred option over point detection due to factors affecting installation, maintenance or the environment to which detectors will be exposed. MZX loops support a range of specialist detectors supplying both power and communications and providing true and seamless integration. Optical Beam detectors connect through beam detector modules and provide options for end to end beams, reflected beams where transmitters and receivers are combined and auto aligning beams where building movement is overcome by on-board alignment correction devices. Open Area Smoke Imaging Detection utilises IR and UV light to provide superior detection in spaces such as Atria, shopping malls and other large open spaces. Multiple detection paths provide a 3D image, similar to a CCTV camera ensuring optimum and reliable early warning of fire.

Aspirating Smoke Detection

Aspiration systems, like Beam detectors, connect directly to the MZX system loop through interfaces integral to the detectors. From the smaller compact systems through the mid to the high end models, integration is complete simply by connecting the two core loop to the device, saving time and cost over systems where external interfaces have to be installed. Communication with the MZX system provides both inputs and output allowing fire and fault signals to be sent to the MZX controller, and for the system to be reset remotely. Aspiration systems are widely used and preferred in challenging situations such as areas of high airflow or where condensation is present or where very early detection is required as in communications and computer rooms. The aspiration system is also ideal for providing detection in equipment cabinets.

Linear Heat Detection

Heat detection may appear limited in its application due to the time it takes to respond to most fires. The Linear versions however are extremely versatile and useful in certain special applications. MZX supports two distinct linear heat detection (LHD) systems which between them cover a diverse range of applications. Analogue LHD senses temperature variation as the resistance of the heated cable changes. The cable will recover and is re-useable providing the temperature does not exceed 120°C for excessive periods. Its uses are typically in confined or difficult areas such as storage racks, escalator housings, cable trays, conveyors and in covered car parks. MZX also supports a fibre optic LHD. The sensor will detect temperature change over several thousands of metres and is accurate in pinpointing the incident to within one metre. Laser pulses sent down the fibre are returned from the section affected by temperature change and analysed in the controller. Multiple zones can be created in a single cable with different detection criteria set for each zone. The controller is available in various formats dependent upon the topology and will interface directly with the MZX fire alarm control panel or alternatively over Modbus/TCP/IP to a SCADA system. Typical applications are tunnels and metros, conveyor systems, parking areas, refineries and power plants.

FIRERAY® ONE Auto Aligning Infrared Optical Beam Smoke Detector



The FIRERAY ONE is perfectly suited for small warehouses, with its cost effective protection and simple installation, as well as new buildings, with the Building Movement Tracking technology continuously maintaining alignment with the detector during the settling process, eliminating nuisance alarms.

Application	Challenge	Fireray One
Small warehouses	Cost effective protection	A standalone beam detector with all the benefits of Fireray Reflective beam detection
	Simple installation	Single point of wiring and commissioning
New buildings	Settling of the building can cause other beam detectors to misalign and result in nuisance alarms	Building Movement Tracking™ automatically compensates for natural building movement to continuously maintain alignment*

*When mounted according to manufactures guidelines

Order Codes

516.015.022 FIRERAY One Auto Aligning Infrared Optical Beam Smoke Detector

Features

- Up to 50m – Single reflector
- Up to 120m – Four reflectors
- Low power consumption
- Can be powered from the loop through BDM800
- Individual alarm and fault relays
- Light Cancellation Technology
- Automatic Contamination Compensation
- One-minute, laser-assisted Auto Alignment
- Building Movement Tracking – Ideal for new buildings
- CE, UL, ULC & VdS approvals

Technical Information

Detection Range:	Detection range 0 to 50m 0 to 120m with Reflective Long Range Kit
Alignment Method:	Laser assisted, Auto-Alignment™. Manual alignment – optional setting
Separation distance between Detector and Reflector:	5 to 50m 50 to 120m with Reflective Long Range Kit
Operating voltage:	14 to 36 VDC
Operating current:	All operational modes – 5mA; Fast alignment mode – 33mA
Cable gauge and type:	2 core, dedicated, 0.5 to 1.6mm (24 to 14 AWG)
Cable entry:	3 knock-out locations capable of accepting M20, ½" or ¾" glands 4 drill-out locations capable of accepting glands up to 21mm diameter
Operating temp:	-20 to +55°C
Storage temperature:	-40 to +85°C
Relative humidity:	0 to 93% (non-condensing or icing)
IP rating:	IP55
Housing flammability rating:	UL94 V0 polycarbonate
Approvals:	UL268 0832-CPR-F2237 Vds G 218070

4.04

Beam Detection

FIRERAY® 5000 Multi Head Auto Aligning Infrared Optical Beam Smoke Detector



The FIRERAY® 5000 motorised, auto aligning infrared optical beam smoke detector can support two detector heads per system, thus saving on installation time and costs. This innovative system has been designed from the ground up to include pioneering technology that fully addresses the needs of the installer and user, both now and in the future.

With its industry leading optics, the FIRERAY 5000 is ideally suited for the protection of large areas where the use of traditional detection technologies would prove to be too difficult and/or costly to install. The FIRERAY 5000 combines an infrared transmitter and receiver in the same discrete unit and operates by projecting a well-defined beam to a reflective prism, which returns the beam to the receiver for analysis. Smoke in the beam path causes a drop in power, which, if below a pre-determined level, results in an alarm signal.

Getting the system operational is simplified by a number of groundbreaking features that combine to make the FIRERAY 5000 the quickest and easiest detector of its type to install. Once the detector heads are connected, using the Easifit First Fix system, an integral LASER, which is aligned along the optical path of the beam, can be activated. This allows the reflective prism to be sighted quickly and with confidence. Once the LASER has been used to coarsely align the beam, the AutoOptimise beam alignment system takes over and automatically steers the beam into the optimum position.

The system can be fully customised, according to local conditions; both alarm thresholds (sensitivity) and time to Alarm/Fault can be set from the ground level System Controller.

Each detector head is independently configurable from 8m through to 100m and has its own individual fire threshold and dedicated fire / fault relay outputs. The System Controller retains one set of Fire and Fault relays that is common to all detectors that are installed.

Features

- Motorised Auto-Aligning
- Up to two Detectors per System Controller
- Controller provides fire and fault relays for each detector head
- Each Detector configurable from 8m to 100m
- Integral LASER
- Auto-Align Fast Automatic BeamAlignment
- Auto-Optimise Building Movement and Contamination Compensation
- Low Level System Controller
- 20mm Cable Gland Knockouts on System Controller
- 2-wire interface from System Controller to Detector
- Worldwide Approvals including EN54:12 and UL268
- Individual fire and fault relays for each detector

Technical Information

Controller	202w x 230h x 81d mm 0.9 Kg
Detector	134w x 135h x 134d mm - 0.5 Kg
Operating Voltage	14 to 36 Vdc
Low power mode	8 mA @ 24Vdc
IP Rating	IP54
Operating Temp	-20 to +55°C
Humidity	93% RH (non condensing) max

Order Codes

516.015.020	FireRay 5000 System (50m)
516.015.021	FR 5000 Detector Head (50m)
516.015.007	FireRay Reflector 100 x 100mm 4 reflectors are required for distances from 50 to 100m
5000-005	Universal Mounting Bracket
5000-006	Flat Mounting Plate for 1 to 4 Prisms
3000-201	Prism Mounting Plate for 4 Prisms
5000-007	Prism Mounting Plate for 1 Prism
5000-008	FireRay adjustable bracket

The FR5000 MultiHead is supplied with one detector head and reflector for single beam operation from 8 to 50 meters. An additional detector head can be added to the controller to enable larger or more complex areas to be protected (Subject to local codes and standards).

The Fireray 5000 when used in its low power mode can be interfaced to the MZX Fire Controller using the BDM800 module.

FIRERAY® 3000 Optical Beam Smoke Detector







FIRERAY® 3000 is ideal for applications where line of sight for the infra-red detection path is narrow and where the building structure uses reflective surfaces. It has been designed to be aesthetically pleasing and therefore equally suits modern architectural buildings as well as heritage sites, particularly where ornate ceilings exist.

FIRERAY® 3000 has been designed so that it can be installed by one operator, with its laser assisted alignment method combined with easy to use alignment LED's offering visual feedback. The integrated laser alignment aid can be activated at the controller or at the receiver head.

An additional detector head set (one transmitter & one receiver) can be added to the controller, separate relay contacts are provided for each of the 2 beam sets.

Mounting Accessories

	Description	Order Codes
	The Universal Mounting bracket can be used with the Fireray 5000 detector head and the 1 or 4 way prism plates to enable the detector head or prism plates to be easily mounted and adjusted when fixing to angled walls or cladding.	5000-005
	The Flat Mounting plate is a metal plate which will support a single prism or 4 prisms, the side mounting holes are compatible with Unistrut® racking systems.	5000-006
	Adjustable bracket for use with the Fireray 3000 heads or Fireray 5000 head.	3000-201
	The large prism plate will securely mount 4 prisms and is designed to be used in conjunction with the Universal Mounting Bracket (not included)	5000-007
	The small prism plate will securely mount a single prism and is designed to be used in conjunction with the Universal Mounting Bracket (not included)	5000-008

Features

- Motorised auto-aligning
- Up to two detectors per system controller
- Controller provides fire & fault relays for each detector head
- Each detector configurable from 8 m to 100 m
- Integral LASER
- Low level system controller
- 20 mm cable gland knockouts on system controller
- 2-wire interface from system controller to detector
- Worldwide approvals including EN54:12 and UL268
- Individual fire and fault relays for each detector

Technical Information

Control Unit:	124 x 203 x 71.5mm / 606g
Transmitter & Receiver:	77 x 78 x 161mm / 207g
Operating Range:	5 to 120 m
Operating Voltage Range:	12 to 36 Vdc \pm 10%
Operating Controller Current:	14 mA (constant)
Operating Transmitter Current:	8 mA (per transmitter)
Power Down Reset Time:	>10 seconds
Fire and Fault Relay Contacts:	VFCO 2A @ 30 Vdc resistive
Operating Temperature:	UL -20°C to +55°C EN54 -10°C to +55°C
IP Rating:	IP54
Relative humidity (non-condnsng):	93%

Order Codes

516.015.030	Fireray 3000 Optical beam detector
516.015.031	FireRay 3000 extra beam set

4.06

OSID Beam Detection

Open-Area Smoke Imaging Detection (OSID)



Open-area Smoke Imaging Detection (OSID) by Xtralis is a new innovation in projected beam smoke detection technology. By using advanced dual wavelength projected beams and optical imaging technology, OSID provides a low-cost, reliable and easy to install solution that overcomes typical beam detection issues such as false alarm incidents and alignment difficulties.

Unique Detection Technology

The OSID system measures the level of smoke entering beams of light projected over an area of protection. A single OSID Imager can detect up to seven Emitters to provide a wide coverage area.

Simple Installation and Maintenance

The OSID system consists of up to seven Emitters, for the 90° Imager unit, located along the perimeter of the protected area, and an Imager mounted opposite. Each component can be mounted directly to the surface or can be secured with the supplied mounting brackets. Battery powered Emitters with up to five years battery life are also available to reduce installation time and cost.

Order Codes

OSI-10	Imager 7° coverage
OSI-90	Imager 80° coverage
OSE-SP-01	Emitter Standard Power
OSE-SPW	Emitter Standard Power, Wired
OSE-HPW	Emitter High Power, Wired
OSID-INST	OSID Installation Kit
VKT-301	OSID Demo Kit (2 x OSE-SPW + 1 x OSI-90 + 1 x OSID-INST + Stand and Carry Case)
OSID-WG	Wire Guard for OSID Imager & Emitter
OSID-EHI	OSID Imager Environmental Housing
OSID-EHE	OSID Emitter Environmental Housing
OSP-001	OSID USB to FTDI Serial PC Interface Cable

Features

- Max detection range of 150 metres for the OSI-10
- Status LEDs for Fire, Fault and Power
- High false alarm immunity
- Dust and intrusive solid object rejection
- Easy alignment with large adjustment and viewing angles
- No need for precise alignment
- Tolerant of alignment drift
- Automatic commissioning in under ten minutes
- Simple DIP switch configuration
- Dual wavelength LED-based smoke detection
- Simple and easy maintenance requirements
- Conventional alarm interface for straightforward fire system integration
- Three selectable alarm thresholds

Technical Information

Supply Voltage:	20 to 30 Vdc (24 Vdc nominal)
Imager Current Consumption	
Nominal (at 24 Vdc):	4 mA (1 Emitter) 7 mA (7 Emitters)
Peak (at 24 Vdc) during training mode:	27 mA
Wired Emitter Current Consumption (at 24 Vdc):	350µA
Battery Version:	Built-in 5 Year Battery
Adjustment Angle:	±60°(horizontal) ±15° (vertical)
Max Misalignment Angle:	± 2°
Dimensions (HWD):	Emitter/Imager 130 x 198 x 96 mm
Operating Temp:	-10°C to 55°C
Humidity:	10 to 95% RH (non-condensing)
IP Rating:	IP44 for Electronics IP66 for Optics Enclosure
Status LEDs:	Fire Alarm (Red) Trouble / Power (Bi-colour Yellow / Green)

VESDA VEP Advanced Aspirating Smoke Detection



The VESDA-E VEP series of smoke detectors bring the latest and most advanced aspirating detection technology to provide very early warning combined with high levels of nuisance alarm rejection. Built on the Flair detection technology and years of application experience, VEP detectors achieve consistent performance over their lifetime via absolute calibration.

Flair is the new detection chamber that forms the core of VESDA-E VEP, providing better detection, fewer nuisance alarms, higher stability, increased longevity and particle characterisation. Direct imaging of the sampled particles using a CMOS imager combined with multiple photodiodes allow vastly more data that can be used to derive actionable information about the observed particles using analytics.

Features

- One and four pipe models for different applications
- Flair detection technology delivers reliable very early warning in a wide range of environments with minimal nuisance alarms
- Multi stage filtration and optical protection with clean air barriers ensures lifetime detection performance
- Four alarm levels and a wide sensitivity range deliver optimum protection for the widest range of applications Intuitive LCD icon display provides instant status information for immediate response
- Flow fault thresholds per port accommodate varying airflow conditions
- Smart on-board filter retains dust count and remaining filter life for predictable maintenance
- Extensive event log (20,000 events) for event analysis and system diagnostics
- AutoLearn™ smoke and flow for reliable and rapid commissioning
- Referencing to accommodate external environmental conditions to minimise nuisance alarms
- Fully backward compatible with VLP and VESDAnet

Order Codes

VEP-A00-1P	VEP-A00-1P VESDA-E VEP aspirating smoke detector with LEDs, 1 pipe
VEP-A00-P	VEP-A00-P VESDA-E VEP aspirating smoke detector with LEDs, 4 pipe
VEP-A10-P	VEP-A10-P VESDA-E VEP aspirating smoke detector with 3.5" Display, 4 pipe

4.08

VESDA Aspirating Smoke Detection

LaserFOCUS Aspirating Smoke Detection



Incorporating detection methodology derived from its VESDA predecessors - the VESDA LaserFOCUS multiple point air sampling technology works by utilising a highly effective aspirator that continually draws air into its laser detection chamber via a pipe network.

Accurate assessment of the air sample using calibrated detection and long detector life expectancy, are assured with a patented dual stage filtration process that both eliminates background 'noise' and preserves the optical integrity of the laser technology with its clean air bleed. The result of which is an unchallenged detection process able to provide reliable and consistent very early warning smoke detection performance across a diverse range of applications.

Features

- Laser Based Absolute Smoke Detection
- Very Early Warning of a Potential Fire Incident
- Wide Sensitivity Range (0.025%-20% obs/m) (0.008 - 6.4% obs/ft)
- Detection Capabilities for smaller critical areas up to 500 m
- Dual Stage Dust Filtration
- Programmable Alarm Thresholds
- Reliable Air Flow Monitoring
- Easy User Interaction
- AutoLearn Smoke & Flow
- Pre-engineered Pipe Designs

Technical Information

Supply Voltage:	18 to 30 Vdc
Current Consumption:	220 mA quiescent 295 mA alarm
Dimensions:	255H x 185W x 90D mm
Weight:	2 kg
IP Rating:	IP30
Operating Temp:	0°C to + 40°C
Sampled Air:	0°C to + 40°C
Humidity:	5% to 95% (non condensing)

Order Codes

516.018.020	VLF-250 Vesda LaserFOCUS (with English overlay)
516.018.022	VIC-010 LaserFOCUS VesdaNetwork Card
516.018.023	VLF-500 Vesda LaserFOCUS (with English overlay)

LaserCOMPACT™ and MZX LaserCOMPACT™



The LaserCOMPACT and VLC800 MZX Laser compact detector has been specifically designed to provide all the benefits of aspirating smoke detection, including very early warning, in single small areas and where space is a premium.

This has been achieved through the combination of approved LaserPLUS detection technology, dual stage filtration technology and a modified aspirator design incorporated in a smaller enclosure with simplified display.

The LaserCOMPACT is available in two versions, one that interfaces via relays only (RO) or across either the relays or VESDAnet™ (VN).

The VLC 800MZX Laser Compact is available with an in-built MZX interface to enable it to communicate directly with the MZX loop.

Features

- Reduced size
- Absolute smoke detection
- Wide sensitivity range
- Single pipe inlet
- Simple display
- Referencing
- VESDAnet communication (VN)
- Dual stage dust filter
- Three alarm levels
- Configurable relays
- Air flow monitoring
- Optional remote display and relay capability
- Simple mounting design
- AutoLearn™
- Marine Approved Version

Technical Information

Supply Voltage:	18 to 30Vdc
Current Consumption:	225 mA quiescent 245 mA in alarm
Dimensions:	225H x 225W x 85D mm
Weight:	1.9 Kg
Operating Temp:	-10°C to+ 39°C
Sampled Air:	-20°C to +60°C

Order Codes

516.018.011	VLC-505-VN VESDA net Version (VN)
516.018.010	VLC-500-RO Relays Only Version (RO)
516.018.012	VLC800 MZX Addressable Vesda LaserCompact (Compatible with MZX Consys versions 2.1 and above)
516.018.030	VLC-500-RO Relays Only Version (RO) Marine
516.018.031	VLC-500-VN Vesdanet Version (VN) Marine
516.018.032	VRT-J00 Remote Display c/w 7 relays Marine

4.10

VESDA Aspirating Smoke Detection

LaserPLUS Standard Modular Range



The detector assembly contains the laser detection chamber, high efficiency aspirator, monitored filter cartridge, control electronics and relay interface. The detector assembly can be used as a “distributed” system, with the display, programmer and VESDAnet socket modules mounted in a remote location.

Alternatively, the detector assembly can be configured as a “self-contained” system by replacing the detector’s blank panels with the display and/or programming modules.



Features

- Wide sensitivity range
- Laser-based light source
- 4 Configurable alarm levels
- Purpose built Aspirator
- 4 In-line Inlet pipes
- Flow sensor for each inlet pipe
- Wide range DC power
- Low-cost maintenance
- Dual stage filter
- Easy access to filter cartridge
- 7 Software configurable relays
- Recessed mounting
- Multiple exhausts

Technical Information

Supply Voltage:	18 to 30 Vdc
Current Consumption:	(No display or programmer) 240 mA quiescent plus 50mA Alarm (24 Vdc at 3000 rpm)
Dimensions:	225H x 350W x 125D mm
Weight:	4.0Kg (including display and programmer modules)
Operating Temp:	0°C to + 39°C
Humidity:	0-95% RH, non condensing

Order Codes

	Description	Order Codes
	VLP-012 LaserPLUS Detector, programmer and display	516.018.001
	VLP-002 LaserPLUS Detector and display	516.018.002
	VLP-400 LaserPLUS Detector with fire OK LED	516.018.013

Remote Displays and Modules



Features

- Four alarm levels (Alert/Action, Fire 1 & Fire 2)
- 20 segment vertical bar graph
- Alarm threshold indicators (Alert, Action & Fire 1)
- Audio and visual indication
- Alarm indicators
- Informative fault indicators
- Multi-mode numeric display (defaults to smoke obscuration)
- Acknowledged push-button presses
- Multiple language supported
- Addressable to any detector

A display module monitors the VESDA LaserPLUS detector. It reports a visual representation of smoke levels, and all alarm and fault conditions. The internal sounder warns personnel in the local area that an alarm threshold has been reached, or a fault has occurred.

It has a 20 segment vertical bar graph, a 2-digit numerical display, an audible sounder and clear alarm and fault indicators. It also has 4 push buttons to control the detector and the mode of the display.

Displays can be located at a convenient location - either within the detector module, or remotely on the VESDAnet. For monitoring convenience, multiple displays can be associated with a single detector.

Technical Information

Supply Voltage	18-30Vdc (when used in detector unit, Remote unit or 19" rack)
Current Consumption	60mA quiescent plus 20 mA Alarm @24 Vdc - (module only) / 90 mA quiescent plus 20 mA alarm @24 Vdc (in remote mounting box)
Dimensions	150H x 140W x 90D mm
Operating Temp	0°C to +39°C
Humidity	10-95% RH, non condensing

	Description	Order Codes
	VRT-400 Remote scanner display including 7 relays VRT-700 Remote scanner display - no relays VRT-800 Remote scanner display with 12 relays	516.018.104 516.018.107 516.018.108
	VRT-200 Remote display including 7 relays VRT-600 Remote detector display no relays VRT-J00 Compact Display c/w 7 relays VRT-K00 Compact Display no relays	516.018.102 516.018.106 516.018.119 516.018.120
	VRT-300 Remote VESDAnet socket	516.018.103
	VRT-100 Remote programmer	516.018.101

4.12

VESDA Aspirating Smoke Detection

LaserPLUS Standard 19 Inch Sub-Rack Remote Display Assemblies



The 19" sub-rack is available as a mounting option, with 4 mounting slots for display or programming modules.

Dimensions: 128H x 482W x 120D mm

Order Codes

516.018.201	VSR-2000 19" Sub-rack with 1 detector display and 3 blanks
516.018.203	VSR-2210 19" Sub-rack, 2 detector displays, programmer and 1 blank
516.018.204	VSR-2221 19" Sub-rack with 3 detector displays and programmer
516.018.206	VSR-2222 19" Sub-rack with 4 detector displays

LaserPLUS Components for Ordering Custom Built Remote Display Sub-racks



Sub-rack configurations other than those available as standard can be supplied as custom built units. The sub-rack and cost of assembly are included in the VSR-CUSTOM. The configuration of the custom built unit must be specified at time of ordering (e.g. 2 x VSU-0 and 2 x VSU-2 configured as VSR-0022)

Note: The order of the numbers (e.g. 0022) indicates the order in which the sub-units will be mounted in the sub-rack housing when looking from the front of the unit - from left to right.

Order Codes

516.018.260	VSU-0 Blank Sub-unit
516.018.261	VSU-1 Programmer sub-unit
516.018.262	VSU-2 Detector display sub-unit plus 7 relays
516.018.264	VSU-4 Scanner display sub-unit plus 7 relays
516.018.265	VSU-5 Blank sub-unit with 7 relays
516.018.214	VSU-E Blank scanner sub-unit with 7 relays
516.018.268	VSU-8 Scanner display sub-unit with 12 relays
516.018.269	VSU-9 Blank display sub-unit with 12 relays
516.018.219	VSU-J Compact display sub-unit plus 7 relays
516.018.210	VSR-CUSTOM Custom sub-rack housing includes cost of custom building 4 VSU sub-rack units

LaserPLUS Standard 19 Inch Rack Remote Display Assemblies



Standard rack enclosure to fit 2 sub-rack assemblies.

Dimensions: 300H x 400W x 140D mm

Order Code

516.018.303	020-050 IP66 Enclosure
-------------	------------------------

LaserPLUS Ancillaries & Power Supply Unit



A variety of other ancillaries are available. Configuration software is available from the Xtralis website www.vision-fs.com.

Order Codes

516.018.402	VHX-0200 PC link HLI plus leads (MK2)
516.018.407	VESDA VPS-220 2 A 24 VDC PSU
516.018.410	VESDA VPS-250-E 2 A 24 VDC PSU
516.018.401	VHH-100 Hand held programmer plus leads

LaserPLUS Spares



The following common VESDA LaserPLUS spares are kept in stock by Tyco Fire Protection Products. Other spares can be supplied if required.

Order Codes

516.018.502	VSP-004 Scanner display (spare)
516.018.505	VSP-019 Filter cover door (spare)
516.018.506	VSP-006 Spare detector chassis and manifold
516.018.508	VSP-008 Spare remote termination card 7 relays
516.018.514	VSP-014 Spare header termination card 7 relays
516.018.515	VSP-015 Spare aspirator fan
516.018.504	VSP-005 Filter cartridge (spare)

VESDA® VLI



The VESDA VLI by Xtralis is an industry first early warning aspirating smoke detection (ASD) system, designed to protect industrial applications and harsh environments of up to 2000 m².

Long life, intelligent, fail-safe technology With an advanced clean-air barrier for optics protection allowing the use of absolute detection and a long detection chamber life without the need for recalibration.

Order Codes

VLI-880	VESDA VLI
VLI-885	VESDA VLI with VESDAnet1
VRT-Q00	VESDA VLI Remote Display 7 Relays
VRT-T00	VESDA VLI Remote Display No Relays

The Intelligent Filter:

- reduces the level of pollution in the air sample before it enters the detection chamber, which dramatically extends the operational life of the detector in harsh and polluted environments.
- is fully monitored, providing consistent sensitivity over the entire operational life of the detector.

4.14

VESDA VEU Aspirating Smoke Detection

VESDA-E VEU Aspirating Smoke Detection



The VEU series of aspirating smoke detectors are the premium detector of the VESDA-E range.

An Ultra-wide sensitivity range; 15 times greater than VESDA VLP, and provision for more sampling holes provide an increased coverage in high airflow applications by up to 40%. Considerably longer linear pipe runs and extended branched pipe network configurations cater perfectly to applications with higher ceilings providing an increased coverage by up to 80% whilst allowing convenient detector mounting for ease of service and maintenance. A range of revolutionary new features provide unsurpassed detection performance, flexibility, field programmability, connectivity and reduced total cost of ownership.

Installation, Commissioning and Operation

VEU features a robust IP40-rated enclosure and is equipped with a powerful aspirator that provides a total pipe length of 800 m. It is fully supported by the ASPIRE-E and Xtralis VSC software applications which facilitate ease of pipe network design, system commissioning and maintenance together with compatibility with existing VESDA installations.

Colour touch screen display

The VEU-A10 detector features a 3.5" colour touch screen display which provides a range of status information including smoke level as well as trouble conditions. A simple navigation system allows the user to view all the status information.

VESDAnet™

VESDA devices communicate on VESDAnet which provides a robust bi-directional communication network allowing continued redundant operation even during single point wiring failures. VESDAnet enables primary reporting, centralized configuration, control, maintenance and monitoring.

Ethernet and WiFi connectivity

VESDA-E detectors offer Ethernet and WiFi connectivity as standard features. The detector can be added to a corporate network, allowing WiFi enabled tablet devices and laptops installed with Xtralis configuration software to connect wirelessly to the detector via the network.

Features

- Short wavelength laser based detection
- Inherent absolute calibration
- Advanced detection technology equivalent to hundreds of thousands of sensors
- Clean air barrier for optics protection
- Most robust contamination resistance
- Ultra-wide sensitivity range
- Flow fault thresholds configurable per port
- Long-life, easy-to-replace filter
- Quiet operation
- LEDs for alarm and fault signalling
- 3.5" colour touch screen for status review
- Advanced remote diagnostics
- Area coverage up to 2,000 m²
- Up to four inlet pipes
- Total pipe length of 800 m
- Referencing
- AutoLearn™ Smoke and Flow
- Seven programmable relays
- Two GPIs, monitored and unmonitored
- Ultrasonic flow sensing
- Xtralis VSC, VSM4 and ASPIRE-E PC software support
- IP 40 enclosure (not UL tested)
- Easy mounting with optional steel support bracket
- Field replaceable aspirator, sampling module, filter and detection chamber
- VESDAnet networking
- Ethernet 100 base T
- WiFi, IEEE488.11/b/g/n
- Local host-mode USB port
- Easy cable termination access
- Event Log (20,000 events)

Backward Compatibility

VESDA-E detectors occupy the same mounting footprint, pipe, conduit and electrical connector positioning as VESDA VLP and VLS detectors hence providing complete backwards compatibility.

How it works

Air is continually drawn from the protected area through the air sampling pipe network and into the detector by a high efficiency aspirator. The air sampling pipe network can contain up to four pipes. The air from each sampling pipe passes through an airflow sensor and then a sample of the air is drawn into the smoke detection chamber via the sampling module, after first passing through the filter.

Technical Information

An additional filter provides clean air to protect the optical surfaces inside the detection chamber from contamination. The Flair™ detection chamber uses the equivalent of 330,000 sensors and sophisticated algorithms for detection and particle classification.

If the detected smoke is higher than the set alarm thresholds it is reported as an Alert, Action, Fire1 or Fire2 alarm condition.

Air is exhausted from the detector and may be vented back into the protected area.

Alarms can be signalled via Relays and VESDAnet. Ethernet and WiFi can be used for configuration and secondary monitoring, and a USB interface is provided for initial setup. A series of LEDs display Alarm, Trouble, Disable and detector power on status. A button allows the user to Reset or Disable the detector. In addition, an optional 3.5" LCD displays detector status including smoke level and a smoke level bar graph, alarm thresholds, trouble status, % airflow level, normalization status and filter life used.

Dimensions (HWD):	225 x 350 x 135 mm
Weight:	VEU-A00 = 4.800 Kg VEU-A10 = 4.835 Kg
Operating conditions:	Ambient: 0°C to 39°C Sampled Air: -20°C to 60°C Tested to: -20°C to 55°C
Humidity:	10% to 95% RH, non-condensing
Sampling network:	Maximum area of Coverage = 2,000 m ²
Minimum airflow per pipe:	15 l/m
Maximum pipe lengths:	Total Pipe Length (with branches) = 800 m Maximum length per pipe, when using four straight pipes = 100 m
Computer design tool:	ASPIRE-ETM
Pipe Inlet:	External diameter 25 mm or 1.05 in (3/4 in IPS)
Pipe Exhaust:	External diameter 25 mm or 1.05 in (3/4 in IPS) via adaptor
Relays:	7 programmable relays (latch or non-latch states)
Contact Rating:	2A @ 30 Vdc (Resistive)
IP rating:	IP40
Cable access:	4 x 26 mm cable entries
Cable termination:	Screw Terminal blocks 0.2–2.5 sq mm (30–12 AWG)
Dynamic Range:	0.0002%/m to 20% obs/m
Sensitivity Range:	0.001% - 20.0% obs/m
Threshold setting range:	Alert = 0.001%-2.0% obs/m Action = 0.001%-2.0% obs/m Fire1 = 0.001%-2.0% obs/m Fire2 = 0.001%-20.0% obs/m

Order Codes

VEU-A00	VESDA-E VEU with LED's
VEU-A10	VESDA-E VEU with 3.5" Display
VSP-960	Mounting bracket (optional) Spare Parts
VSP-962	VESDA-E Filter
VSP-962-20	VESDA-E Filter - 20 pieces
VSP-963	VESDA-E Aspirator
VSP-964	VESDA-E Smoke Detection Chamber
VSP-965	VESDA-E Sampling Module

4.16

ICAM Aspirating Smoke Detection

ICAM IAS800 Air Sampling Smoke Detection



The ICAM IAS800 Air Sampling Smoke Detection System provides a flexible solution to meet the unique needs of numerous applications including industrial spaces such as cable tunnels, tamper proof and unobtrusive requirements for special accommodation, or can simply be used to replace spot (point) detectors in office environments.

The IAS800 system actively draws air from the protected area through sampling holes in a pipe network. Sampled air is then filtered before being analyzed by upto two MZX Technology detectors.

The IAS800 system is available in three configurations:

- IAS800 twin inlet pipe configuration which can be fitted with two detectors for monitoring one or two pipe runs.
- IAS801 single inlet pipe configuration which can be fitted with one detector.
- IAS802 twin inlet pipe configuration which can be fitted with two detectors for monitoring one or two separate pipe runs with independant fault outputs.

The system utilises a high performance aspirator and software configurable flow monitoring circuitry. The air flow level is displayed on a ten element bar graph that can be adjusted for high and low flow thresholds, and flow failure is reported as a device fault via upto two MZX Technology MIM800 addressable modules.

Applications:

Ideal for areas where access is restricted, harsh environments and areas where a point detector would be damaged. Such as:

- Lift Shafts
- Floor / Ceiling Voids
- Cabinet Protection
- Conveyor Tunnels
- Hose Down Areas
- Stables
- Prison Cells
- Areas with Low Ceilings

Features

- Powerful fan
- Upto two x 50 m pipe runs
- Pipes can be individually monitored for air flow with LED bar graph
- MZX Loop and 24 Vdc connections
- Fault monitored via the MZX Loop
- IP65 enclosure
- Field serviceable air filters
- Uses standard 25 mm Vesda pipe & fittings

Detectors sold separately.

Technical Information

Supply Voltage:	18 to 30 Vdc
Current Consumption:	300 mA
Dimensions:	259w x 184h x 166dmm
Weight:	2.77 Kg
Operating Temp:	-10 to +55°C (with detectors)
Humidity:	10 to 90% RH NonCondensing
Sampling Pipes:	25 mm dia, 50 m per inlet

Order Codes

516.016.301	ICAM IAS800 Aspirated Smoke Dual Detector common fault monitor
516.016.303	ICAM Course Filter (PK10)
516.016.304	ICAM IAS801 Aspirated Smoke Single Detector common fault monitor
516.016.305	ICAM IAS802 Aspirated Smoke Dual Detector dual fault monitor
516.016.306	ICAM In-Line Filter Housing









VESDA Pipe, Fittings and Test Equipment



Features

- Toughness and durability
- Chemical resistance
- Easy to joint
- Low Friction
- Wide temperature range
- Lightweight
- Red colour for easy identification













Aspirating Pipe & Fittings

	Description	Order Codes
	Pipe 25 mm diameter (2.4m Length) VESDA aspirating pipe, printed along its length on opposite side at 450 mm intervals. 2.4m length pipe. Order in multiples of 10.	JC008-1
	Grey Pipe 25 mm diameter (2.4m Length) VESDA aspirating pipe, printed along its length on opposite side at 450 mm intervals. 2.4m length pipe. Order in multiples of 10.	JCG008-1
	Socket 25 mm Straight socket for 25 mm pipe. Order in multiples of 10.	516.018.902
	Socket union 25 mm Socket union to facilitate servicing of pipework. Order in multiples of 1.	516.018.903
	Socket Adaptor 25 mm to 3/4" Socket adaptor, imperial to metric, to extend existing systems. Order in multiples of 5.	516.018.909
	Bend 25 mm 90 degree Long Radius bend. Order in multiples of 5.	516.018.904
	Elbow 25 mm 45 deg elbow. Order in multiples of 5.	516.018.905
	End cap 25 mm. Order in multiples of 5.	516.018.906
	Equal Tee 25mm. Order in multiples of 5.	516.018.907

4.18

VESDA Aspirating Detection Pipe, Fittings and Accessories

Aspirating Pipe & Fittings

	Description	Order Codes
	In-Line Filter Suitable for all Vesda Aspirating Smoke Detectors.	516.018.925
	Filter Elements Dual density replaceable filter elements for use with In-Line Filter (Pack of 4).	516.018.926
	Water Condenser Water Condenser for use with Vesda ASD Systems	516.018.927
	Pipe Clip 25 mm. Order in multiples of 10.	516.018.908
	Solvent Cement Solvent Cement (0.25 Litre Tin)	516.018.910
	Capillary Tube Conical Sample Point Assembly 25 mm socket adaptor + 2 m capillary tube (tube colour - red).	516.018.911
	Capillary Tube Flush Sample Point Assembly 25 mm socket adaptor + 2 m capillary tube (tube colour - red)	516.018.912
	Capillary Tube 10 mm 10 mm o/d x 30m length (tube colour - red).	516.018.915
	Pipe Cutter	516.018.918
	Pipe Ties (Red) Order in multiples of 100.	516.018.920
	Sampling Point Label (1 Reel) Order in multiples of 100.	517.017.005
	Pipe Label (1 Reel) Order in multiples of 100.	517.017.006

Wire Burn Test Box

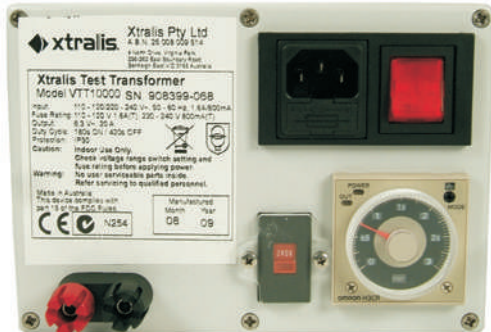

Wire burn test box designed to heat up a measured length of special wire to produce smoke, used to test the transport time and performance of Vesda aspirating smoke detectors.

Features

- Built in timer
- Insulated terminals
- Selectable input voltage
- Illuminated power on indicator
- Robust enclosure
- Supplied with UK power lead

Technical Information

Input Voltage:	110-120 or 220-240VAC
Output Voltage:	6.3 VAC @ 20 A
IP rating:	IP30
Timer:	1 to 3 mins
Dimensions:	135H x 170W x 120D mm
Weight:	2.75 Kg

Order Code

516.018.921 Wire Burn Test Box

Smoke Test Wire



Smoke test wire for use with the wire burn test box.

Technical Information

Dimensions:	10/0.1 mm, 0.078 mm ² CSA
Length:	100 m
Weight:	0.25 Kg

Order Code

516.018.923 Smoke Test Wire

4.20

MZX SensorLaser Plus Fibre Optic Linear Heat Detection

MZX SensorLaser™ Plus Fibre Optic Linear Heat Detection



The MZX SensorLaser™ Plus guarantees fast and continuous fire detection even in difficult and varying ambient conditions. This linear heat detection system enables long and heavily fragmented facilities such as traffic and supply tunnels, cable routes and conveyor belts as well as large scale buildings such as production halls, cold stores and multi storey car parks to be monitored at all times. The MZX SensorLaser™ Plus is ideal for use in areas that are hard or impossible to access after installation, e.g. false floors, since maintenance and troubleshooting can be carried out from the control unit.

The fibre optic sensor cable itself is maintenance free and, thanks to its particularly robust characteristics, offers a high level of security against false alarms. The sensor cable is insensitive to dust, dirt, moisture, high temperatures (up to approx. 90 °C), pressure and the action of vibration and wind as well as corrosive atmospheres. Because of its purely passive, optical analysis process, the MZX SensorLaser™ Plus is even immune from electromagnetic interference caused by generators, energy routes, cables or electric motors.

The MZX SensorLaser™ Plus delivers precise information about the location, size and spread of a fire even under ambient conditions that would cause other fire detection systems to fail.

The MZX SensorLaser™ Plus enables a measuring range of up to 8 km per sensor cable. Up to 2 spurs each with an 8 km measurement range, or 1 loop with an 8 km range can be connected. Since the ambient conditions in a monitoring area of this size can vary enormously, each sensor cable can be divided into up to 256 zones. Several alarm criteria can be freely defined in each zone. This level of precision adjustment allows the MZX SensorLaser™ Plus to provide a high level of resistance to false alarms and precise fire detection despite contrary and variable ambient conditions.

Features

- Continuous detection despite extremely large monitoring area
- Easy and rapid installation of the maintenance free sensor cable
- Very high resistance to extreme ambient influences (immune against heat, cold, humidity, corrosion, strong winds and draft)
- Undiminished operation under electromagnetic interference
- Unprecedented security against false alarms
- Very high sensor cable service life of up to 30 years
- Temperature profile over the complete measurement range delivers exact information of location, size and spread of fire
- Very low maintenance costs as maintenance and trouble shooting can be done from the control unit
- VdS certified to EN 54 part 5
- One controller unit will drive up two 8 km spurs or one 8km loop
- Easy integration into existing installations
- Each sensor cable divided into up to 256 zones
- Individual configuration of 5 alarm criteria per zone
- Network connection through Modbus, TCP/IP, FTP and SCPI interfaces

The accessible laser radiation emitted by the Class 1M laser is not hazardous to the eyes (provided there are no other optical instruments in the path of the beam), while operation is absolutely fail-safe even in the event of a break in the cable. In addition, the sensor cable can be used in explosive atmospheres (ATEX zones) up to zone 0 without any additional measures being required. In contrast to conventional fibre optic systems, the low laser output of < 20mW ensures that the measuring system has a long service life.

Zone Configuration

Ambient conditions (temperatures) can fluctuate sharply over a measuring range of many hundreds of metres. This makes it essential to divide the measuring range into zones that can be adapted optimally to the ambient conditions on the basis of differing alarm criteria. This ensures high detection reliability and also security against false alarms.

The MZX SensorLaser™ Plus allows the measuring range to be very finely divided into zones. Up to 256 zones can be defined for each sensor cable, with up to 5 alarm criteria configurable in each zone. Another 2 alarm criteria respond when there is a temperature drop, enabling them to be used e.g. in tunnels to warn of black ice.

Control Unit

With ten product variants, permitting measuring ranges of 1 to 8 km, the MZX SensorLaser™ Plus can be configured to suit the particular project.

Sensor Cable

The sensor cables offered are optimised for a rapid response time. The sheathing is flame retardant, halogen free and resistant to dust, dirt, moisture, corrosive atmospheres and most organic solvents. Both types of sensor cable offer adequate protection against rodents and are designed for a service life of 30 years.

There are two different types of sensor cable for differing requirements. The MZX SensorLaser™ Plus Safety cable can be used under normal ambient conditions. It is particularly flexible and extremely versatile.

Where the sensor cable is expected to be exposed to high mechanical stresses, we recommend that the MZX SensorLaser™ Plus Steel Wire Armoured cable be used. This sensor cable, which was specifically developed for heavy duty applications, is particularly suitable where high tensile forces and high lateral pressures can occur.

The cable length will be individually cut to the customer specified length and 2 connectors are fitted for easy handling. The cable should be commissioned in multiples of one metre and therefore the order for the cable has to be placed per metre.

Every order for sensor cable must include the corresponding connectors, which will be assembled by the supplier. The cable with pre assembled connectors offers fast commissioning of the system without any additional splicing.

Mounting Materials

For professional mounting of the sensor cables four different types of mounting sets are available. These sets are designed for different applications. They can be used for the mounting of the sensor cable to the wall and the ceiling. Every set contains 100 x clamps, 100 x anchors and 1 x SDS drill bit.

Plastic Clamps

The plastic of these clamps is UV resistant, halogen free and particularly robust in ambient conditions.

Steel Clamps

The clamps in these sets are made of stainless steel or zinc plated steel and are rubber protected. The rubber protection guarantees that the sensor cable is not damaged if friction occurs. For every clamp 2 x nuts are included for fixing to the anchor.

Connection Cable

Connection to the MZX Fire Alarm Panel is by means of the MZX SensorLaser™ Plus Connection Set. This set consists of 3 x cables. For connection of the Fire Alarm Panel to one end of the sensor cable a D-Sub connector is included. The other end of the sensor cable is desoldered which provides a quick connection into the MZX System without any soldering effort.

Enhanced Communication

The MZX SensorLaser™ Plus iBox allows the 20 relay outputs supplied as standard to be expanded up to 2 x 256 outputs so that each zone can be assigned its own relay output. This could, for instance, be used to control fire extinguishing systems. The iBox also enables connection to SCADA or process control systems via Modbus TCP or Modbus RTU.

The number of relays can be extended using the MZX SensorLaser™ Plus Relay Controller Set. This set consists of a pre-programmed field bus controller, one Digital Output Module and an End module. It also comes with 8 x relays and accessories for easy wiring.

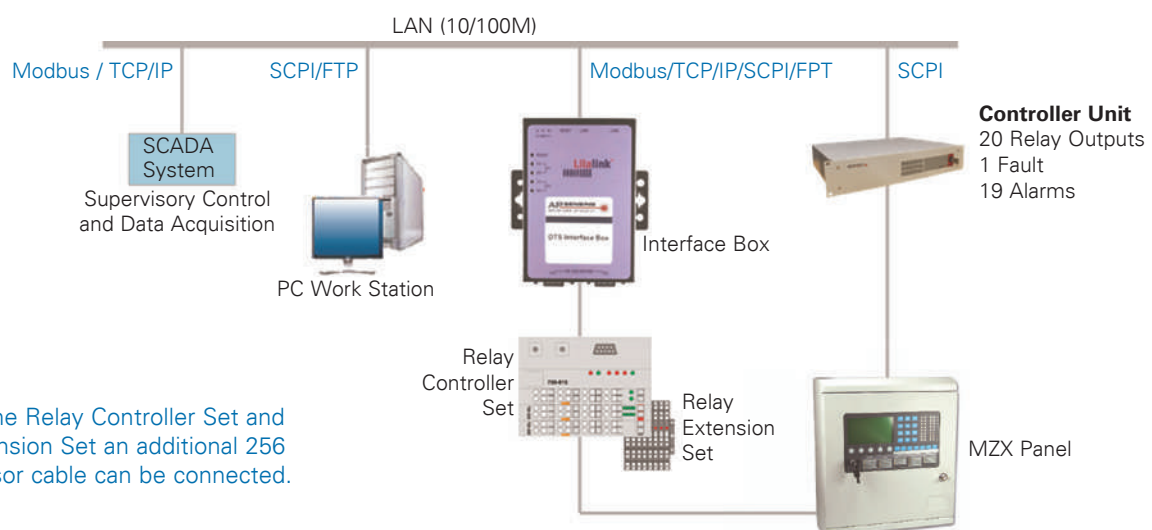

By means of the Relay Controller Set and the Relay Extension Set an additional 256 relays per sensor cable can be connected.

4.22

MZX SensorLaser Plus Fibre Optic Linear Heat Detection

Complies with the essential requirements of the following applicable European Directives and carries the CE marking accordingly:

- The Low Voltage Directive 73/23/EEC amended by 93/68/EEC
- The EMC Directive 2004/108/EC

Conforms with the following product standards:

- IEC61326:1997+A1:1998+A2:2000
- EN61326:1997+A1:1998+A2:2001
- CISPR11:1997+A1:1999 / EN55011:1998+A1:1999
- IEC61000-4-2:2001/EN61000-4-2:1995+A1:1998+A2:2001
- IEC61000-4-3:2002/EN61000-4-3:2002
- IEC61000-4-4:2001/EN61000-4-4:1995+A1:2001+A2:2001
- IEC61000-4-5:2001/EN61000-4-5:1995+A1:2001
- IEC61000-4-6:1995+A1:2000 /EN61000-4-6:1996+A1:2001
- IEC61000-4-8:2001/EN61000-4-8:1993+A1:2001
- IEC61000-4-11:1994+A1:2000
- EN61000-4-11:1994+A1:2001
- Canada: ICES-001:1998

Technical Information

Operating Temp:	-10°C to +60°C (2 channel options from -5°C)
Storage Temp:	-40°C to +80°C
Sensing Temp:	-273°C to +700°C depending on sensor coating
Operating Humidity:	0% to 95% RH (2 channel options: 15% to 85% RH) non condensing
Dimensions (HWD):	88 x 448 x 364mm (19" rack)
Weight:	9kg
Fibre Types:	MM 50/125 µm graded index
Dynamic Range:	MM 62.5/125 µm graded index
Optical Connector:	30dB (2-way loss)
Number of Channels:	E2000; 8° angled
Computer interface:	1, 2 depending on channel option
Relay Board:	USB, LAN
Power Supply:	4 inputs / 20 outputs
Power Consumption:	10V to 30Vdc 15 W typically, at 20°C ambient temperature < 40 W (entire operating conditions)
Measurement Times:	From 10s to 30s
Spatial Resolution:	1m; 1.5m; 3m; 5m; 8m
Measurement Modes:	Single ended/Dual ended; including fibre break recovery
Internal Data Storage:	150 traces total
Power Supply (option)	
Operating Conditions:	0°C to +50°C; non condensing;
Laser Class:	indoor use only 1M (IEC 60825-1: 2001)

Safety

- IEC61010-1:2001/EN61010-1:2001
- IEC60825-1:2001/EN60825-1:1994+A11:1996+A2:2001
- Canada:CAN/CSA-C22.2No.61010-1:2004
- USA:UL61010-1:2004;FDA21CFR1040.10+Laser Notice No.50

Order Codes

516.016.310	MZX SensorLaser™ 1/1 – 1km range, 1 sensor cable
516.016.311	MZX SensorLaser™ 1/2 – 1km range, 2 sensor cables
516.016.312	MZX SensorLaser™ 2/1 – 2km range, 1 sensor cable
516.016.313	MZX SensorLaser™ 2/2 – 2km range, 2 sensor cables
516.016.314	MZX SensorLaser™ 4/1 – 4km range, 1 sensor cable
516.016.315	MZX SensorLaser™ 4/2 – 4km range, 2 sensor cables
516.016.316	MZX SensorLaser™ 8/1 – 8km range, 1 sensor cable
516.016.317	MZX SensorLaser™ 8/2 – 8km range, 2 sensor cables
516.016.318	MZX SensorLaser™ Connection Set
516.016.319	MZX SensorLaser™ iBox
516.016.320	MZX SensorLaser™ Relay Controller Set
516.016.321	MZX SensorLaser™ Power Supply
516.016.322	MZX SensorLaser™ Safety Cable (per metre)
516.016.322.C	MZX SensorLaser™ Safety Connector
516.016.323	MZX Steel Wire Armoured SensorLaser™ Cable (per metre)
516.016.323.C	MZX SensorLaser™ Steel Connector
516.016.324	MZX SensorLaser™ Setting Tool
516.016.325	MZX SensorLaser™ Relay Extension Set
516.016.326	MZX SensorLaser™ Zinc Plastic Clamp Set (PK 100)
516.016.327	MZX SensorLaser™ Steel Plastic Clamp Set (PK 100)
516.016.328	MZX SensorLaser™ Steel Zinc Clamp Set (PK 100)
516.016.329	MZX SensorLaser™ Stainless Steel Clamp Set (PK 100)
516.016.330	MZX SensorLaser™ Spare Unit
516.016.331	MZX SensorLaser™ Demo Unit

ProReact Analogue Linear Heat Detector



ProReact Analogue Heat Detector system consists of a control module and four core detection cable designed to interface to a conventional fire alarm panel or DIM800 or DDM800 addressable module. The control module monitors the resistance of specially doped polymers within the sensor cable which change as a function of temperature. An abnormal change in resistance along the detection cable triggers either a Pre- Alarm or Alarm on the interface module.

The system is intended to simplify system design and be uncomplicated and straightforward to install. Commissioning of the controller can be done using a laptop computer or through an optional built-in self-programming module. The sensor cable has been designed to be physically and electronically rugged to suite a range of environments with options for PVC, Polypropylene or Nylon coatings or a strong stainless steel braid.

The ProReact technology offers an alternative solution to heat protection in a wide range of applications and industries, from power generation to oil and gas.

Features

- Alarm & Pre-Alarm temperature ranges from 54-100°C
- Programmable on-site adjustment of sensitivity.
- Up to 500 m continuous length
- Alarm hot-spot length equal to 3% of zone length
- Separate Alarm and Pre-alarm volt-free outputs
- No nomograms or other scales to interpret
- Simple, 3-Step Installation:
- Ambient temperature compensation maintains alarm temperature accuracy
- Self-Restorable after fire event up to 125°C
- Flexible cable for easy mechanical installation
- Reliable signalling of open and short circuit conditions
- Extrusion and Braiding options to satisfy both mechanical and environmental conditions

Order Codes

516.016.019	ProReact Analogue Cable PVC order in multiples of 200
516.016.020	ProReact Analogue Cable PVC order in multiples of 500
516.016.021	ProReact Analogue Cable with additional Polypropylene coating order in multiples of 200
516.016.022	ProReact Analogue Cable Polypropylene coating order in multiples of 500
516.016.023	ProReact Analogue Cable Nylon coating order in multiples of 200
516.016.024	ProReact Analogue Cable Nylon coating order in multiples of 500
516.016.025	ProReact Analogue Cable Stainless Steel Braid order in multiples of 200
516.016.026	ProReact Analogue Cable Stainless Steel Braid order in multiples of 500

Control Units

516.016.016	ProReact ProReact Analogue Controller with display including EOL unit
516.016.017	ProReact ProReact Analogue Controller including EOL unit
516.016.018	End of line unit (Spare)

Technical Information

Environmental

Ambient Operating Temp (Controller)	0°C to +50°C
Sensor Cable (Recoverable)	-40°C to +125°C
Continuous Sensor Cable Operating Temp	-40°C to +90°C
Humidity - Controller	0% - 95% RH (Max. 75% RH for <75 m cable and 54°C alarm setpoint)
Humidity - Cable	0% - 99% RH

Electrical

Operating Voltage	20 Vdc – 28 Vdc
Current Consumption (Normal & Fault)	<70 mA (Base PCB only < 50 mA)
Pre-alarm OR Alarm Conditions	<80 mA
Pre-alarm AND Alarm Conditions	<100 mA
Relay outputs	2A @ 30 Vdc load rating - resistive
Alarm & Pre-alarm FORM C	0.25 A @ 250 Vac (62.5 VA) load rating - resistive

4.24

ProReact Analogue Linear Heat Detection

Linear Heat Detection Non-Combustible Cable Supports



Installation standards such as BS5839 part 1 specify non-combustible cable supports and this requirement extends to linear heat sensor cable. To satisfy this requirement the ProReact Analogue Heat Detector range includes a range of fixings in either Zintec or Stainless Steel and compatible cable ties.

Order Codes

516.016.220	Dual Height L cable clip 100 mm Zintec
	Standard L Clip 50 mm Zintec
516.016.221	Channel bracket for attaching LHD cable to flat surface Zintec
516.016.222	V-clip for cable trays Spring Stainless Steel
516.016.223	L clip with edge clip Zintec
516.016.224	Clip extension for use with other clips where required Zintec
516.016.225	Dual Height L cable clip 100 mm Stainless Steel
516.016.230	Standard L Clip 50 mm Stainless Steel
516.016.231	Channel bracket for attaching LHD cable to flat surface Stainless Steel
516.016.232	L clip with edge clip Stainless Steel
516.016.234	Clip extension for use with other clips where required Stainless Steel
516.016.235	110°C indoor/outdoor cable tie UV & Heat Stabilised Pack of 100
516.016.236	170°C indoor tie wrap Not UV stabilised Pack of 100
516.016.237	170°C indoor tie wrap Not UV stabilised Pack of 100
516.016.238	170°C indoor/outdoor stainless steel tie wrap Pack of 100

ProReact Digital Interface Monitor Module



Thermocable's ProReact Digital interface Monitor Module (DiMM) is designed to enhance the functionality of existing or new Digital LHD systems. The Module is intended to be installed between the Digital LHD cable and a conventional or addressable fire alarm control panel.

The DiMM simultaneously monitors two zones of Digital LHD cable (up to 3,000 metres per zone) for an alarm or fault condition. If an overheat or fire situation triggers either zone of the Digital LHD cable, the DiMM automatically calculates and displays the distance along the cable, in feet and metres, to the alarm point. The two zones can operate independently of each other or in interlock/coincidence detection mode to eliminate the possibility of false alarms.

An RS-485 Modbus RTU output also allows direct connection into a PLC or other process control system.

Technical Information

Inputs*

Max zone length:	3000m
Min zone length:	1m
End of line resistor:	1k ohm (Included)
Short circuit current:	0.5mA
Max voltage:	5V
Ground fault impedance:	0 ohms

Outputs

Communications:	2 wire RS-485 Modbus RTU/ASCII
Sounder:	2.4kHz 92dBa@10cm Buzzer
Alarm	2 volt-free relay contacts
Max voltage:	30Vac or 42.4Vdc
Max current:	2A
Max switching power:	60W, 62.5V
Fault	2 x optoisolated photo-transistor output
Max voltage:	35Vdc
Max current:	80mA
Max power dissipation:	150mW

* Upto two Class B zones of ProReact Digital LHD Cable

** All circuit power limited if powered from a power limited supply

Features

- Advanced functionality for traditional Digital LHD systems
- Pinpoints exact location of an incident and responds immediately
- Simultaneous monitoring of up to two zones
- Power indicator, fault and alarm lights for each zone
- Volt-free outputs for fault and alarm, corresponding to each zone
- Can be connected to an industrial process control system using the two-wire RS485 Modbus RTU output
- Built-in sounder for audible annunciation
- Interlock/Coincidence detection eliminates the possibility of false alarms by requiring both LHD cables to trigger before transmitting an alarm

Order Codes

- 516.016.027** ProReact Digital interface Monitor Module (2-zone independent/interlock monitoring unit)
- 516.016.028** LHD Junction/EOL Box Polycarbonate w/5 DIN Rail mounted terminals & 2 cable glands
- 516.016.029** ProReact Digital One or two zone digital LHD end-of-line box with test facility

Mechanical

Dimensions (HxWxD):	180 x 120 x 60.5 mm
Rating:	NEMA 4, 4X (IP65)
Finish:	Light Gray with clear lid
Display:	2 line, 16 character backlit display showing zone status
Terminal block spacing:	5mm Rising Clamp
Terminal block wire size:	0.08mm ² (28AWG) to 4mm ² (11AWG)

Electrical**

Operating voltage (UL Tested):	14Vdc Min / 24Vdc Nominal / 36Vdc Max
Operating voltage:	12Vdc Min / 24Vdc Nominal / 36Vdc Max
Current cons. (Standby):	<15mA Min / <7mA Nominal / <5mA Max
Current cons. (Alarm):	<40mA Min / <23mA Nominal / <15mA Max
Terminal block rating:	16A
Supervised circuits:	Power, Input Zone 1 & Input Zone 2

Environmental

Operating Temperature:	-20°C to +50°C
------------------------	----------------

4.26

ProReact Digital Linear Heat Detection

ProReact Digital Linear Heat Detection Cable



Thermocable's ProReact Digital LHD cable has been designed to provide users with fire detection at the point of risk. Every inch of the ProReact Digital LHD cable acts as a detector providing extensive and comprehensive detection over large areas.

ProReact Digital LHD cable triggers a response when a specific activation temperature is reached. The extensive range of coatings and detection temperatures provides users with a suitable method of fire detection for a wide range of applications.

Typical applications for LHD cable include: cable trays, tunnels, flammable liquid storage tanks, mines, cold storage, escalators, car parks & warehouses.

ProReact Digital LHD Cable

- Activation temperatures of 68°C, 78°C, 88°C, 105°C, 185°C
- Broad ambient operating temperature range
- UL, FM, CE and RoHS approved
- Comprehensive range of coatings and optional stainless steel outer braid for additional protection

ProReact Plus Digital LHD Cable

- Activation temperatures of 65°C, 75°C, 85°C, 100°C, 110°C
- Fully UL approved and CE marked
- Flame retardant and highly oil and fuel resistant
- UV stable for indoor and outdoor use

ProReact VHT Digital LHD Cable

- Activation temperature of 230°C
- Can withstand continuous ambient operating temperatures of up to 170°C
- UL, FM, CE and RoHS approved

Technical Information

ProReact Digital LHD

Construction:	Overall insulated, twisted pair of tri-metallic cores
Insulation:	1kV tested protective outer coat
Additional Insulation Options:	Nylon, Polypropylene or Stainless steel braiding
Approvals:	CE Marked, RoHS Compliant, FM, UL, GOSTR
Max Zone Length:	3,000m
Wire Overall Diameter:	3.60mm to 5.08mm
Minimum Bend Radius:	50mm
Ambient Temp Range:	-40°C to +125°C
Max Voltage Rating:	30Vac, 42Vdc
Resistance:	~100 ohm/km per leg
Velocity of Propagation:	~55%
Capacitance:	88-150 pF/m
Inductance:	540-1050 nH/m







ProReact Plus Digital LHD

Construction:	Overall insulated, twisted pair of tri-metallic cores
Insulation:	1kV tested protective outer coat
Additional Insulation Options:	Stainless steel braiding
Approvals:	CE Marked, RoHS Compliant, cUL and UL
Max Zone Length:	3,000m
Wire Overall Diameter:	3.66mm to 4.06mm
Minimum Bend Radius:	50mm
Ambient Temp Range:	-60°C to +69°C

ProReact VHT Digital LHD

Construction:	Overall insulated, twisted pair of tri-metallic cores	Weight:	42.50kg per km 55.50kg per km with additional steel braid
Inner coating:	Very high temperature polymer	Continuous Ambient Temp Range:	-40°C to +170°C
Outer coating:	Silicone rubber	Activation Temperature:	UL - 21 8°C, FM - 235°C
Insulation:	5kV tested protective outer coat	Max Voltage Rating:	100Vdc, 70Vac
Additional Insulation Options:	Stainless steel braiding	Resistance:	~1 00Ω/km per leg
Pending Approvals:	UL 521 and FM Class 321 0, CE, RoHS Compliant		
Colour:	Green (in accordance with NFPA 72 & UL 521)		
Max Zone Length:	3,000m (max individual reel length 500m)		
Wire Overall Diameter:	5.00mm +/- 0.1 mm 5.50mm +/- 0.1 mm with additional steel braid		
Minimum Bend Radius:	63.5mm		

Order Codes

	Description	Order Code 100m	Order Code 200m	Order code 500m
	ProReact Digital LHD 68°C PVC	516.016.030	516.016.031	516.016.032
	ProReact Digital LHD 78°C PVC	516.016.033	516.016.034	516.016.035
	ProReact Digital LHD 88°C PVC	516.016.036	516.016.037	516.016.038
	ProReact Digital LHD 105°C PVC	516.016.039	516.016.040	516.016.041
	ProReact Digital LHD 68°C Nylon outer sheath order	516.016.042	516.016.043	516.016.044
	ProReact Digital LHD 78°C Nylon outer sheath order	516.016.045	516.016.046	516.016.047
	ProReact Digital LHD 88°C Nylon outer sheath order	516.016.048	516.016.049	516.016.050





4.28

ProReact Digital Linear Heat Detection

Order Codes (Continued)

	Description	Order Code 100m	Order Code 200m	Order code 500m
	ProReact Digital LHD 105°C Nylon outer sheath order	516.016.051	516.016.052	516.016.053
	ProReact Digital LHD 185°C Nylon outer sheath	516.016.054	516.016.055	516.016.056
	ProReact Digital LHD 68°C Stainless steel outer braid on PVC	516.016.057	516.016.058	516.016.059
	ProReact Digital LHD 78°C Stainless steel outer braid on PVC	516.016.060	516.016.061	516.016.062
	ProReact Digital LHD 88°C Stainless steel outer braid on PVC	516.016.063	516.016.064	516.016.065
	ProReact Digital LHD 105°C Stainless steel outer braid on PVC	516.016.066	516.016.067	516.016.068
	ProReact Digital LHD 185°C Stainless steel outer braid on Nylon	516.016.069	516.016.070	516.016.071
	ProReact Plus Digital LHD 65°C LSZH coating	516.016.072	516.016.073	516.016.074
	ProReact Plus Digital LHD 75°C LSZH coating	516.016.075	516.016.076	516.016.077
	ProReact Plus Digital LHD 85°C LSZH coating	516.016.078	516.016.079	516.016.080
	ProReact Plus Digital LHD 110°C LSZH coating	516.016.081	516.016.082	516.016.083
	ProReact Plus Digital LHD 65°C Sst. outer braid on LSZH coating	516.016.084	516.016.085	516.016.086

Order Codes (Continued)

	Description	Order Code 100m	Order Code 200m	Order code 500m
	ProReact Plus Digital LHD 75°C Sst. outer braid on LSZH coating	516.016.087	516.016.088	516.016.089
	ProReact Plus Digital LHD 85°C Sst. outer braid on LSZH coating	516.016.090	516.016.091	516.016.092
	ProReact Plus Digital LHD 100°C Sst. outer braid on LSZH coating	516.016.093	516.016.094	516.016.095
	ProReact VHT Digital LHD Silicone	516.016.096	N/A	516.016.097
	ProReact VHT Digital LHD Stainless steel outer braid on Silicone	516.016.098	N/A	516.016.099

Solista LED Beacon (Conventional Only)



A Solex 10 Candela Xenon Beacon with a red lens and a white shallow base which can be used wherever a high power xenon beacon is required. Due to the high power output and current consumption it is recommended that this device is not used with the MZX-c+ or similar small panels (an SB520 sounder booster module and PSU may be required in some cases).

Features

- High Power – 10 Candela
- Current Surge Suppression
- High Efficiency – 88 mA at 24 VDC
- 1Hz Flash Rate
- Protected to IP54
- Wide Operating Voltage (10 to 60 Vdc)
- Operating Temperature -25°C to + 70°C

Order Code

576.501.232 Solex 10 Beacon (Red lens / white base)

Please Note: This beacon should be used for supplementary indication purposes only. In this case the device is not required to be used as a Visual Alarm Device (VAD) and EN54-23 is not relevant to its classification.

Flashni Sounder / Beacon



A combined sounder and beacon which combines the features of the Roshni electronic sounder with a fully integrated Xenon beacon.

These sounders are fully compatible with all Roshni tones.

Please Note:

These beacons should be used for supplementary indication purposes only. In this case the device is not required to be used as a Visual Alarm Device (VAD) and EN54-23 is not relevant to its classification.

Features

- Combined strobe & sounder
- Matches Roshni sounders
- Weather Resistant to IP65

Technical Information

Dimensions:	93 Dia x 92D mm (Shallow base) 93 Dia x 121D mm (Deep base)
Input Voltage:	18-30 Vdc
Typical Current:	68 mA @ 24 Vdc
Typ. Sound Output:	101dB (A) @ 1 m

Order Codes

20-118	Combined Roshni sounder/strobe complete with deep base (IP65)
576.501.224	Combined Roshni Sounder/Strobe, Red Body/Red Lens complete with shallow base & tone switch
576.501.227	Combined Roshni Sounder/Strobe, Red Body/Red Lens, deep base, tone switch & separate sounder/strobe operation



Network and Graphics

Tyco Expert Graphics (TXG)

Network Interface Modules

CCU3 Interfaces

MZX BACnet Converter

5.02

Network & Graphics

Network & Graphics

MZX technology offers a range of panels from a single loop to 32 loops. Each panel can address upto four thousand addresses and is configurable up to 240 zones. Panels can be easily networked by adding a network card. An MZX network can be extended up to 99 panels with panels interacting with each other where required. The network is a true peer to peer network which remains unaffected by a single node failure. Furthermore failure of any panel's main processor will not inhibit transmission of any fire alarm or fault signal from that panel across the network to a designated panel's zonal display. Networks can be created using a wide range of cable types or fibre optics.

The network will support the Tyco Expert Graphics (TXG), Emergency Management System and Graphical User Interface. The system provides annunciation, status display and control for the MZX network either to a single or multiple stations. Multiple stations are connected as true clients of the dedicated primary station, (server) and can be on the clients own network if desired. TXG is windows based system which uses a combination of symbols, floor plans, pictures, text, voice messages and video input to display events and create actions for the operator. TXG is user friendly and simplifies the operator's actions, saving valuable time in an emergency.

Third Party Interfaces

When Fire alarm systems have to be interfaced to a third party's system such as BMS, there are no specials with MZX technology. The MZX to BACnet interface provides high level communication between the fire alarm and building automation systems. The BACnet client will display both point and zone events together with various system statuses and analogue detector values. The system also supports commands thereby providing a seamless bidirectional interface.

A MODBUS interface also exists for the MZX network allowing connection via a number of protocols to the third party system. Multiple units can be interconnected within a single system. The module has on-board relays which can be configured as inputs to the MZX Technology system plus a number of supervised inputs whose status can be read from the MODBUS map.

Tyco Expert Graphics (TXG)



Tyco Expert Graphics is a new client/server emergency management system and fire detection graphical user interface.

TXG is based on a Tyco graphical alarm monitoring system that has been installed on hundreds of large fire detection and alarm monitoring systems around the world and offers the ability to integrate all Fire Panels with MZX technology, such as PROFILE and MZX series with improved functionalities.

Tyco Expert Graphics provides annunciation, status display, and control for various fire detection and alarm systems including MZX networks incorporating the latest MZX Technology™ fire detection systems. It also supports the predecessor Minerva fire detection systems thus ensuring that future updates from Minerva to MZX Technology can be accommodated. Additional support is provided for Simplex 4100 range, Zetfas and Fast2000\ PBS (Token ring format).

TXG is a Microsoft Windows® based graphical interface with a high resolution colour display. Responsive touch-screen (optional) buttons with realistic icons and keyboard provide control switches specific to the operation being performed. Utilising a combination of symbols, floor plans, pictures, text, voice messages and video input, TXG displays the precise location and gives instructions on what emergency action should be taken.

The display can be configured to track detector inputs by changing the colour of areas in response to changes in analogue value. A detailed map of the area affected can be printed automatically for use by personnel responding to an emergency. Prompt response to a fire emergency, with the correct action, provides the opportunity to reduce financial loss and greatly improves safety.

Much of the work involved in configuring TXG has been simplified through the automatic import of panel configurations, AutoCAD® graphics, including data points, and the ability to use a wide range of input data file types including GIF, JPG, bitmap, Vector and WAV files.

Features

- Provides annunciation, status display, and control in both normal and emergency situations
- Developed specifically to provide monitoring and control of fire protection life safety systems
- Supports a range of fire detection systems:
- PROFILE and MZX, Simplex 4100 range 4100, 4120, 4020, 4100U with upgrade paths to 2120 Zettler Zetfas, Wormald PBS16, Tyco Fast 2000
- Multiple workstations can be configured for specific functions or redundant operation
- Single monitor or two monitor (text and graphics) support at each workstation

Additional Features:

- Link up with I.P. CCTV camera systems, no additional wiring, reduced installation cost for a fully integrated fire\CCTV system
- Compatible with Flamevision® FV300 array based IR flame detectors with built in CCTV
- MZX Hotspot, chromatic analogue display, Programmable tracking of analogue values, Changes display colour in response to changes in analogue value from a selected number of MZX devices
- Trending diagrams of analogue values helps reduce maintenance time and cost
- Export analogue values to Excel for in depth analysis
- Audio descriptions of screens can be played when they are displayed or played when an event occurs
- High level user interface allows end user to make changes to point attributes and layout further reducing lifetime cost of ownership
- Centralised security administration means that operator accounts are administered through the TXG client's common database
- Mouse, keyboard or touch-screen control with full multimedia compatibility
- Dual language switching
- The ability to display live video when specific predefined alarm conditions occur
- Easy to configure and set-up. No special networking or PC training required
- Facilities and maintenance management report and analysis tools are available

System maintenance can be carried out via the high level user interface with the ability to edit the position and attributes of point icons as well as make changes to drawing layouts. As well as simplifying maintenance, being a true client server application means that any number of on-site or off-site workstations can interrogate the database with pre-defined security levels to facilitate any required combination of access and control.

5.04

Tyco Expert Graphics

The IP Video feature allows real-time images of the area at risk to be displayed in the event of an alarm or fault. Video capture of the affected area appears on the screen automatically, allowing the severity of the situation to be assessed quickly and the appropriate executive action to be taken.

For less serious incidents, expensive and unnecessary plant shut downs can be avoided. In more critical situations, accurate information can be quickly and efficiently communicated to the response team. Icons representing the devices being monitored will change colour dependant on status (Alarm, normal, fault, isolate etc).

Selected areas can be highlighted using the chromatic analogue display feature, MZX HOTSPOT. As the analogue value of a monitored point changes the chromatic analogue display will change the highlight colour through a pre-defined range.

For example a heat detector assigned MZX HOTSPOT could transit the highlight from blue to red. The number of chromatic steps is dependent on the resolution of the graphics card used, 16, 24 or 32 bits

Notification by email

Events, whether they are real or false alarms are handled most efficiently when information can be quickly and accurately communicated. TXG allows users to set up email groups and notification texts linked to predetermined events. These are automatically transmitted ensuring that the appropriate resource is deployed.

Additional features and functions

- Response buttons with configurable icons or text provide control switches specific to any operation being performed
- Uses a combination of symbols, floor plans, pictures, text and video to communicate events
- Standard MZX and Minerva symbol libraries supplied
- Instructions given on emergency action to be taken
- Maps and instructions printed to assist response teams
- History logging recallable or printable by event, dates, device, or a host of other available filters
- An advanced filter allows history reports to be specifically limited to a particular range or date
- Commands to control outputs from the Graphical User Interface
- Events can be accepted individually or can be "auto-accept"
- Supports all standard PC image file types (i.e. GIF, JPG, BMP), AutoCAD® & Vector file types

Availability and order process

TXG can be downloaded from the tycoemea.com website and can be used with a time restriction for demonstration or training purposes. TXG can also be ordered from our Letchworth and Ect distribution centres.

Customers can fax or e-Mail an order form which details the software options required, to customer service at Letchworth. Original order forms can be obtained from <http://www.ZettlerFire.com/>. This form will allow customer service to prepare and allocate a license code that will activate the required features. Customers will also be required to place an order on JDE for each part number on the form.

A media pack containing CD with license number, dongle, multi language manuals on CD and original order form will be dispatched to the customer.

On receipt, the software can be loaded and the license number entered to make available the requested software features.

Order Codes

508.040.100	TXG USB Server Dongle/License/ Software
508.040.001	TXG001-Single Client with 1 panel (Requires TXG USB)
508.040.002	TXG004-Single Client with 2 to 4 panels (Requires TXG USB and TXG001)
508.040.003	TXG010-Single Client with 5 to 10 panels (Requires TXG USB, TXG001 and TXG004)
508.040.004	TXG020-Single Client with 11 to 20 panels (Requires TXG USB, TXG001, TXG004 and TXG010)
508.040.005	TXG999-Single Client with 21 or above panels (Requires TXG USB, TXG001, TXG004 TXG010 and TXG020)
508.040.011	TXG-C Additional Client license
508.040.021	TXG-MIN80 Minerva driver license
508.040.025	TXG-OPC - OPC Alarm / Event & Data Access Server Licence
508.040.027	TXG-CPP - SIMPLEX CPP driver
508.040.033	TXG-PBS/FAST2000 DRIVER

TXG IS TOTALLY SCALABLE



.....FROM A SINGLE FIRE ALARM PANEL CONNECTED TO A TXG SERVER.....

The modest additional cost of a single TXG client/server is easily justified when the benefits that a Graphical User Interface bring are considered.

TXG with direct connection to a single PROFILE panel

.....TO A COMPLEX INSTALLATION WITH MULTIPLE DIVERSE NETWORKS AND DISTRIBUTED CLIENTS

Large multi-building facilities may have a number of fire detection networks, possibly installed over an extended period of time. TXG can be used as a hub to integrate these systems with a number clients providing annunciation and control where it is needed.

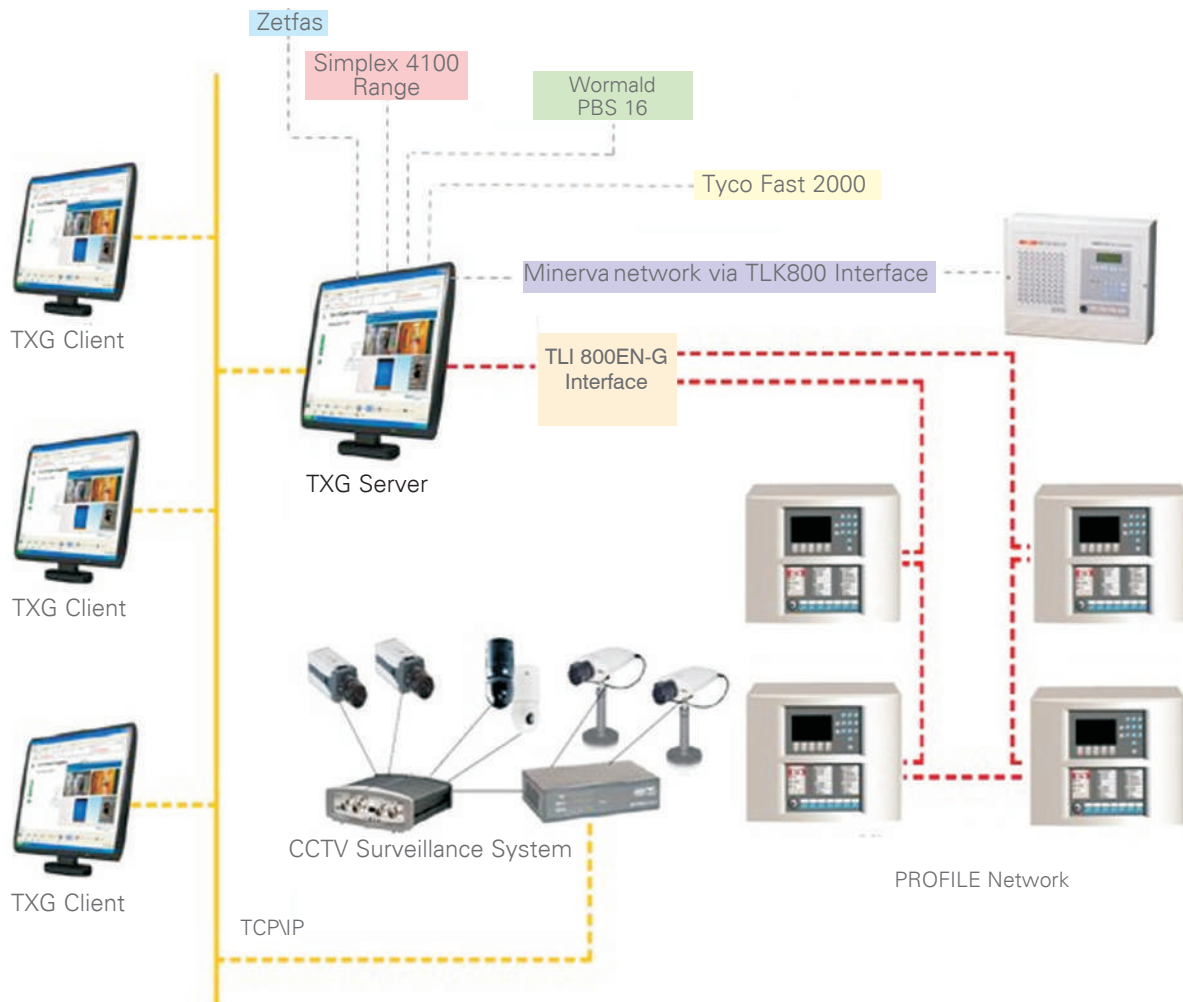

TXG with multiple fire detection networks and CCTV integration

5.06

Network Interface Modules

TLI800EN Network Interface Module and FOM800 Fibre Optic Module

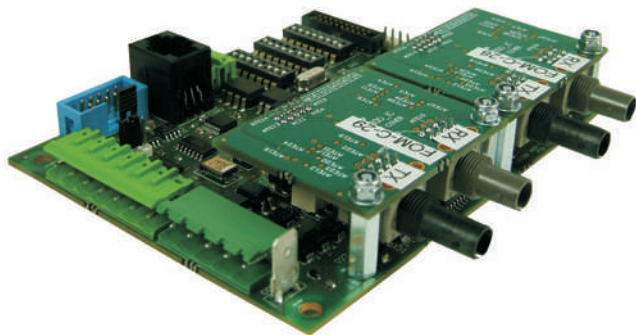

Inter-controller Network

The use of the MZX Technology Network allows the fragmentation of a number of fire controllers to be drawn into a network system. Because every installation is different, the MZX Technology Network has been designed to be highly flexible, allowing for a wide range of different systems applications. With a large network system the amount of data and information passing between fire controllers can become high during an emergency condition. The MZX Technology Network communication protocol has been specifically designed with this in mind and ensures that each event message passed around the network is acknowledged by the receiving controller in the fastest possible time.

Operation

The network is totally flexible and enables from 2 to 99 fire controllers to be seamlessly linked together.

System Overview

The MZX Net communications network comprises a collection of network interface modules and peripheral equipment that together form a fault resistant, and flexible peer-to-peer network for the MZX Digital addressable fire systems controllers.

Features

- Allows MZX Technology Fire Controllers to be “seamlessly” networked together
- Dual ARM 7 RISC processors
- Support for Emergency Mode Indication
- True peer-to-peer communications; no host or master controller required
- Highly resilient, node failure open and short circuit does not affect remaining network
- Approved to EN54-13 and EN54-2
- Up to 99 controllers may be used on the network
- Wide range of cable topography supported
- Network can use a variety of cable types with up to 2500m between nodes (cable dependent), 1200m using standard 1.5 mm MICC cable
- FOM800 Plug on fibre optic module provides up to 5000m between nodes using 62.5/125 multimode fibres
- Easy to install and programme
- Simple to operate

Order Codes

557.202.080	TLI800EN Network Card and cable
557.202.081	FOM800 Fibre Optic Module
557.200.039	TLI800EN Network Interface in Housing c/w PSU
557.180.219	PC to TLI800 EN Network Card connection Cable

Master operating stations use the standard MZX or PROFILE Fire Controller hardware. In this application, the controller changes its personality; and enables additional information from each controller on the network to be displayed.

Cable Parameters		
Maximum wire to wire capacitance		Resistance
Baud rate	Capacitance	Maximum resistance = 40 Ohm for EN54-13 compliant installation. Maximum resistance = 65 Ohm for proper function without compliance.(all baud rates)
38400	0.3 uF	
19200	0.6 uF	
9600	1.2 uF	
2400	1.2 uF	
1200	1.2 uF	

Mode of Operation

The MZX Technology Network employs a token passing communications protocol that treats each node on the network equally. Loss of one or more nodes does not affect the operation of the remainder of the network.

Data is regenerated at each node in the network enabling maximum distance between nodes. In the event of a short/open circuit on the network between any two nodes, isolation will automatically occur and the network will re-configure communications and continue to allow communication between all nodes physically connected.

The MZX Technology Network offers a high level of system integrity, allowing safety critical actions to be passed across the network from one Fire Controller to another. This very high level of system integrity enables the MZX Technology Network to meet the requirements of EN54-13 and EN54-2.

In the event of loss of communication with the host controller, the TLI800EN will use its secondary processor to monitor the controllers fire outputs and if necessary can activate the controllers emergency fire input. In addition it can support a LED annunciator for network panel fire indication, this is wired to a MPM800 via the TLI800EN's integral RBus RS485 port.

Fibre Optics

Fibre optics can also be supported on the MZX Technology Network system by fitting one or two FOM800 modules to the TLI800EN network card, this uses either type 62.5/125 or 50/125 multi-mode fibres between nodes on the network. Use of fibre permits a maximum distance between nodes of up to 5000 metres in either bus or ring topology.

FOM800 Fibre Optic Network Interface

Mechanical

Dimension:	50 x 58 x 12 mm
Weight:	0.015 Kg
Housing:	The FOM800 is mounted directly onto the TLI800EN Network card

Electrical

Supply Voltage:	Powered from TLI800EN
Network Connections:	2 x ST Fibre optic connections
Cable Type:	62.5/125 or 50/125 multi-mode fibre optic cables

Environmental

Operating Temp:	-10°C to + 55°C
Storage Temp:	-10°C to + 70°C
Relative Humidity:	95% (100% intermittent)

Technical Information

TLI800EN Network Card

Mechanical

Dimensions:	116 x 90 x 20 mm
Weight:	0.10 Kg
Housing:	The TLI800 Network PCB is mounted directly onto the MZX CPU800 within the panel enclosure

Electrical

Power Consumption:	74 mA @ 24 Vdc & 20 mA @ 5 Vdc
Network Connections:	2 x RS 485
Network Diagnostic:	9 x on board LED's / RS232 port for system analysis and fault finding
Cable Type:	2 Core MICC, Shielded or Twisted pair
Connectors:	Screw terminals, will accept 2.5 mm ² cable

Network Parameters

Number of nodes:	99 (max)
Distance between nodes:	1000 to 5000 metres (dependent upon cable type)
Communications type:	RS485
Baud Rates:	9.6K to 115.2K
Transport Type:	Token passing, non-collision protocol

Environmental

Operating Temp:	-10°C to + 55°C
Storage Temp:	-10°C to + 70°C
Relative Humidity:	95% (100% intermittent)

TLI800EN-G Housed Network Card with PSU

Mechanical

Dimension:	300 x 200 x 85 mm
Weight:	3.85 Kg

Electrical

Supply Voltage:	220 to 250 VAC
Power Consumption:	160 mA

Environmental

Operating Temp:	0°C to +55°C
Relative Humidity:	95% max

5.08

CCU3 Interface & BACnet Converter

CCU3 Interface Module



The CCU3/C-MZXMB provides a MODBUS interface to a number of MZX panels on an MZXNet. CCU/IO boards may also be connected to provide general I/O devices accessed through the MODBUS interface.

Technical Information

Input Voltage:	18-30 Vdc
Current:	150 mA at 24 Vdc
Dimensions:	140 x 105 x 15 mm

Order Code

557.202.046	MZX CCU3/C-MZXMB MZX to MOD Bus Interface
-------------	---

The CCU3/C-MZXMB connects to panels on the MZXNet via a TLI800EN (TPI) interface card using RS232 (PL2 socket). It connects to MODBUS via either an RS232, RS485 (default) or RS422 connection. Another port allows up to 8 CCU/IO boards to be connected. Each CCU/IO has 8 relay outputs that can be used as inputs to the panel. These contacts are controlled via WRITE commands to the MODBUS map. Each CCU/IO also has 8 supervised inputs whose status can be read from the MODBUS map.

MZX BACNet Interface



The BACnet interface (UC-8112-ME-T-LX) replaces the old MZX BACnet interface (UC-8112-LX). It is backward compatible and can be used with the current range of MX, ZX, MZX and PROFILE Fire detection panels.

The BACnet UC-8112-ME-T-LX is a 12 to 36V DC input voltage unit and is needed when powered by the panel auxiliary output or PSU. It will launch with firmware version 3.0 and support MX Speak up to version 6.0.

Please note that firmware 3.0 is incompatible with the BACnet UC-7101 LX unit, therefore firmware version 2.03 is required.

Features

- High level interface to building automation systems
- Meets interfacing requirements for large integrated projects
- Low cost solution – no need for expensive bespoke integration solutions
- Sales opportunities in the integrated solutions market

Order Code

557.202.082	Moxa UC-8112-ME-T BACnet Interface
557.202.083	RJ12 Cable for connection to TLI800EN/FIM800

For stand-alone MX, ZX, MZX and Profile Phase 1 panels, the new BACnet interface can take serial data directly from FIM800. For a networked system, the new interface requires a dedicated TLI-800EN network card.

For a stand-alone Profile Flexible, the BACnet interface requires a PNI800 and a dedicated TLI-800EN network card (can't be connected directly to PFI800 nor PNI800)

The documentation and Firmware 3.0 that needs to be installed onto the BACnet interface (UC-8112-ME-T-LX) device will be provided by Technical Support, email: techservices-detection@tycoint.com



Hazardous Area Protection

Flame Detectors
Addressable Protection
Conventional Protection
Sounders & Beacons

6.02

Hazardous Area Protection

Hazardous Area Protection

MZX systems include the most extensive range of products which are suitable for and approved for use in all classes of hazardous areas. The range extends from intrinsically safe detectors for use on conventional systems to flameproof and intrinsically safe flame detectors for use in the most demanding environments, both on and off shore. A complete range of barriers, housings, call points, ancillary modules and sounders is provided to enable a complete system to be supplied. Systems 620 conventional and system 800 addressable solutions include detailed design guides ensuring the system designer has all the tools to implement a safe and effective solution. ATEX and IECEx approvals are in most cases for both dust and gas hazards. In addition to individual component approvals both conventional and addressable systems have systems certification.

Flame Detectors

MZX Infra-Red Flame detection offers unrivalled performance where hydrocarbon based fires exist. IR detection is less susceptible to radiation inhibitors than is UV, being able to detect through oil mist, smoke and vapour, all of which can be commonly associated with fires involving fuels. They are also less prone to false alarms from background radiation sources. IR sensors are tuned to a bandwidth typical of the radiation emitted from Carbon Dioxide which is present in hydrocarbon fires. Single channel detectors are set to a fixed frequency and then rely on flame flicker, whereas triple channel detectors can monitor frequencies above and below the fire threshold filtering background radiation from non-fire sources. Array based IR detectors use 256 sensors making them sensitive yet extremely stable. The array can be configured to ignore hot spots such as exhausts, flues and flame stacks. The detector in addition to all other approvals is IEC61508, (SIL2) approved. Some models can also incorporate a CCTV camera within the detector housing, providing real time images of the incident. All of the above detector types are available within the MZX range covering all categories of risks.

Addressable Detection

800 series Addressable detectors are intrinsically safe and use galvanic isolators when connected to the MZX loop. Galvanic isolators do not require a high integrity earth connection as the primary and secondary circuits are not directly interconnected. This offers the installer a much easier and less costly installation and removes the need for regular checking to ensure continuous earth continuity. Available detection technologies are Multisensors, Smoke/Heat detector, Carbon Monoxide/Heat detector, Ionisation detector, Heat detector and the single channel IR, point detector. Each sensor offers flexibility in programming and offers various modes of operation which can be selected to suit the risk. All detectors connect to a common intrinsically safe approved base and have ATEX and IECEx approval for use in both gas and dust atmospheres.

Callpoints

Both indoor and outdoor Call points are available for use in hazardous areas. Alternatively suitable non-addressable devices can be connected to the MZX loop via an addressable interface. Manual call points are themselves simple devices and can be connected via a galvanic isolator, or be constructed so as to be incapable of causing ignition, or be enclosed within a flameproof enclosure. In addition to the type of protection offered the device is also rated for use in a particular (gas group) atmosphere and temperature rated so as never to exceed the ignition temperature of any gas or dust /air mixture present. MZX offers the widest range of call points and interfaces to meet the required standard whilst minimising the amount of equipment to be installed.

Sounders, Beacons and Accessories

Installing sounders and beacons into hazardous areas requires careful consideration and design experience. Whilst electrical safety is still paramount so is the need to create a distinct and audible signal. Within the MZX range there are both sounders and beacons which are either intrinsically safe, when used with an appropriate safety barrier, or flameproof in their construction. Sounders and beacons offer a range of outputs to suit all environments which when connected through the appropriate module/driver will minimise the risk to the designer and ensure a safe and adequate system is provided. A number of I/O units mounted within flameproof enclosures complete this very comprehensive range of hazardous area equipment.

Conventional Detection

System 620 provides a range of conventional detectors very similar to the 800 series addressable. Conventional detection circuits also require a safety barrier, galvanic, (for new systems) or shunt diode (for extending some older systems), in order to meet safety requirements. Conventional detectors can be connected to an appropriate approved control panel or an interface and onto an MZX loop, within an adjacent safe area. Within the product range are Multisensors, Smoke/Heat detector, Carbon Monoxide/Heat detector, Ionisation detector, Heat detector and the single channel IR, point detector. All detectors connect to a common IS labelled base and have ATEX and IECEx approval for use in both gas and dust atmospheres.

6.04

Flame Detectors

FLAMEVision Flame Detectors



The FLAMEVision flame detectors use patented IR array and triple IR solar blind technologies to provide reliable and cost effective fire detection solutions. FLAMEVision can be trusted in high dependency situations where fast acting and accurate flame detection is essential. FLAMEVision detectors offer superior performance in all weather conditions and all lighting situations with the added benefit of fire event location information provided by the IR array.

FLAMEVision can protect all hydrocarbon risks in classified hazardous explosive and non hazardous atmospheres. There is a wide range of system design options available with flexible monitoring and control interfaces and integrated video camera for verification purposes. Installation and maintenance procedures are easy and efficient, minimising the lifetime cost of ownership and reducing the need for complex test equipment and high level operator training.

Features

- Reliability Choice of IR array or enhanced Triple IR solar blind technologies allow users to tailor their systems to provide reliable and fast fire detection.
- Fast Acting FLAMEVision reacts to minimise the effect of fire and improve life safety through detection with less disruption and downtime.
- Accuracy Event location information will pin point fire using the IR array to allow targeted shutdown and suppression.
- Operator verification The optional built-in video camera assists operator verification and ensures optimum actions are taken. Additional benefit of post event analysis and to aid and verify alignment.
- Optimum protection in all weather conditions FLAMEVision maintains sensitivity using the enhanced IR sensors through heavy rain, snow, fog and morning dew.
- Use in Hazardous explosive atmospheres FLAMEVision is approved for protection regardless of area classifications for all applications throughout the facility.
- Reduced spares inventory and simpler maintenance Intrinsically safe, low cost and easy to use test equipment simplifies maintenance and reduces service costs. Universal mechanical mounting and cabling arrangements makes FLAMEVision installation friendly.
- Easy integration FLAMEVision interconnects to site control and safety systems via a range of standard industrial interfaces.
- Dynamic masking FLAMEVision maintains detection coverage even when a flame is part of the process being protected.
- Complete piece of mind FLAMEVision detectors continually monitor all electronics and perform regular optical window tests.

FLAMEVision FV300

FLAMEVision FV300 uses Infra-Red Array based sensing technology to provide the ultimate programmable flame detector. An array of 256 infra-red sensors plus two optical channels view the protected area.

Powerful algorithms running on a Digital Signal Processor (DSP) are tuned to the characteristics of a fire and analyse the signals from these channels to quickly and reliably identify fires. A key advantage of using an array is that the detector can accurately identify the location of the flame within the field of view. The location information is used to overlay a marker on the live video output to highlight the fire location. The user can quickly see the location of one fire or multiple fires and decide on the appropriate action. The location information is also available on the field network interface. User defined areas within the field of view can be masked and un-masked dynamically to improve reliability and maintain maximum coverage at all times.

The FV300 has an optional integral colour video camera which displays a live image of the field of view. This is in addition to the alarm location and status information which is available as standard on the video output.

Features

- Advanced array based detector
- Powerful signal processing on DSP with algorithms to give reliable flame detection
- Detection range: Over 50m for 0.1m² n-heptane pan fire
- Field of view: 90° horizontal, 85° vertical with full range maintained
- High immunity to false alarms
- Solar blind
- Masking of areas in field of view
- Automatic optical path monitoring
- Advanced self test and service features
- Built-in video camera (option): View protected area with alarm location and status overlay
- IEC 61508 Approved (SIL2)

Order Codes

516.300.006	FV311S Inra-red array flame detector
516.300.008	FV311SC Inra-red array flame detector PAL Camera
516.300.007	FV311SC-N Inra-red array flame detector NTSC Camera
516.300.411	FV411f Triple infra-red flame detector
516.300.412	FV412f Triple infra-red flame detector PAL camera
516.300.413	FV413f Triple infra-red flame detector NTSC camera

FLAMEVision FV400

FLAMEVision FV400 uses Triple IR Solar Blind technology for flame detection. This provides a reliable and cost effective solution in standard flame detection applications especially where there is a single hazard in the field of view. The FV400 FLAMEVision detectors use Triple IR Solar Blind sensing technology and flame detection algorithms to provide high performance sensing capabilities for hydrocarbon fires. This includes the ability to reliably sense flames through high densities of solvent vapours and black smoke, increasing the probability of early detection with consistent high sensitivity to flame throughout the whole field of view. They also ensure consistent detection of many different types of hydrocarbon fuels from alcohol to aviation fuel. Multiple interfaces are provided with the option of an integral CCTV camera to provide a visual means of operator verification.

Features

- Triple IR solar blind sensing technology
- Multiple Field Interfaces
- Detection range: Up to 65m for 0.1m² n-heptane pan fire
- Automatic optical path monitoring,
- Integral flame simulation and remote walk test help reduce the on going life time cost of the flame detecti installation
- Video verification via the integrated optional flameproof camera

EX II 2 GD

FV411F:

EX d IIC T4 Gb Ta -40°C to +80°C

EX d IIC T5 Gb Ta -40°C to +75°C

EX td IIIC T135°C Db Ta -40°C to +80°C

EX td IIIC T100°C Db Ta -40°C to +75°C

FV412F and FV413F:

EX d IIC T4 Gb Ta -40°C to +80°C

EX d IIC T5 Gb Ta -40°C to +70°C

EX td IIIC T135°C Db Ta -40°C to +80°C

EX td IIIC T100°C Db Ta -40°C to +70°C

Ancillary Equipment

517.300.001	MB300 FLAMEVision Mounting Bracket
517.300.002	WH300 FLAMEVision Weather Hood
517.300.021	WT300 FLAMEVision Walk Test Tool
517.300.022	CTI300 FLAMEVision Off-line Configuration Tool
517.300.024	CTI400 FLAMEVision Off-line Configuration Tool
517.300.006	MK300 FLAMEVision Field Spares Kit

6.06

Flame Detectors

Technical Information

Mechanical - Detector

Dimensions:	155.5H x 153W x 92D mm
Weight:	4kg
Gland entry:	2 x M20
Material:	Stainless steel 316L, ANC4BFCLC to BS3146: Part 2
Guard/label plate:	Stainless steel 316S16 to BS1449: Part 2
Screws external:	Stainless steel 316 A4
Detection window:	Sapphire
Camera window:	Toughened glass

Mechanical - Bracket

Dimensions:	181H x 125W x 95 mm
Weight:	1.54kg
Material:	Stainless steel 316S16 to BS1449: Part 2

Environmental

Operating temp:	-40°C to +80°C
Storage temp:	-40°C to + 80°C
Operating temp (camera):	-10°C to +50°C
Storage temp with camera:	-20°C to + 70°C (operating temperature is reduced for T5 risks)
Relative humidity:	99% (non condensing)
Enclosure IP Rating:	IP66

Flameproof Certification

FV300
Ex II 2GD EX d II C Ext D A21 IP66/67 T4 T135°C
(T amp = -40°C to 80°C) or T5, T100 (T amp = -40°C
to +70°C)

EN54 Approval

CPD EN54-10:2002 + A1:2005
FV400 is classified as Class 1 on the Extended and
Normal range settings.
FV400 is certified as Class 3 on the Half range setting.
FV300 is classified as Class 1

Camera Specification

Composite video:	(1V p-p) into 75 Ohm via twisted pair balun
Horizontal resolution:	Standard 450 TVL
Light sensitivity:	0.3 Lux (-30 IRE)

Detector performance

Range:	FV400 65m, FV300 5 m (0.1m ² n heptane)
Field of view:	90° horizontal, 85° vertical

Interfaces

FV300

Modbus
4-20 mA Sink or source
Fire & fault relay contacts NO or NC
Composite video o/p

FV400

Modbus
4-20mA Sink or source
Conventional detector I/F
Tyco MZX Digital
Fire & fault relay contacts NO or NC
Composite Video o/p (Camera option only)
Hart interface (Implemented in future software update)

Electrical

FV300

Supply voltage:	20 to 30Vdc
Current consumption :	196mA Quiescent 205 mA Alarm (24Vdc)
Heater:	245mA @ 24Vdc
Connections:	2.5mm ² (14AWG) Terminals

FV300

Supply voltage:	15 to 30Vdc
Current consumption:	12mA Quiescent 22mA Alarm (24Vdc - interface dependent)
Camera:	185mA @ 24Vdc
Heater:	245mA @ 24Vdc

External supply required only for camera, heater or
MODBUS options

Connections:	2.5mm ² (14AWG) Terminals
--------------	--------------------------------------

Order Codes

516.300.006	FV311S Infrared array flame detector
516.300.008	FV311SC Infrared array flame detector - PAL camera
516.300.411	FV411f Triple infrared flame detector
516.300.412	FV412f Triple infrared flame detector with PAL camera

Ancillary Equipment

517.300.001	MB300 FLAMEVision mounting bracket
517.300.002	WH300 FLAMEVision weather hood
517.300.021	WT300 FLAMEVision walk test tool
517.300.022	CTI300 FLAMEVision offline configuration tool
517.300.024	CTI400 FLAMEVision offline configuration tool
517.300.006	MK300 FLAMEVision field spares kit

S200 Plus Triple IR Solar Blind Flame Detector-IEC 61580 Approved (SIL2)



As part of an intrinsically safe circuit, the S200 Plus is suitable for zones 0,1 and 2 where group IIC gases or lesser hazards can be continuously present in explosive concentrations.

Technical Information

Detector Material:	Stainless Steel 316L/316
Dimensions:	167H x 167W x 89D mm
Weight:	4.5Kg
Gland Entry:	2 x 20mm
Range:	0.1m ² petrol at 50m 0.4m ² petrol at 60m
Operating Temp (I.S.):	-40°C to +80°C (IECEX & ATEX)
Response Time:	Field Selectable 3, 6 and 12s
Sensitivity:	3 range settings
Relative Humidity:	95% (100% intermittent)
Enclosure:	IP66 and IP67

Types S231i+, S241i+ and S271i+

IECEX BAS 05.0051
Ex ia IIC T5 (-20°C < Ta < +40°C)
or T4(-40°C < Ta < +80°C)

Features

- Triple waveband infrared solar blind flame detection for optimum false alarm immunity
- Unrivalled black body rejection over a wide range of source temperatures
- Range adjustable to 50 metres for a 0.1m² petrol pan fire
- Discrimination of optical faults (dirty windows) from other faults by the built-in self test feature
- Housing designed for easy installation of cabling
- Addressable, relay or 4-20mA models available
- Patented dual filter for complete solar blindness
- 100° field of view
- ATEX and IECEX approved

Additional Intrinsically Safe S200 Plus Features

- Flexible mounting and angular adjustment
- 2 x 20 mm field cable entries
- IP66/67 housing designed for external use
- Rugged 316 stainless steel housing and mounting bracket
- Variable response times and sensitivity settings
- Remote self test and range setting
- True window test in detection area (i.e. not in the edge of the window)
- Terminals provided for Remote LED connection where relevant
- BASEEFA (CENELEC) certified
- Approved to EN54 Pt 10
- IEC 61508 Approved (SIL2)
- DNV and LRS certified
- Very low power consumption (0.35mA)
- Models available with Conventional or Analogue Addressable interface (requires 2 core cable only)

Order Codes

516.037.004	S231+ Conventional interface triple IR I.S. Flame Detector
516.038.004	S241+ 4-20MA interface triple IR I.S. Flame Detector
516.041.004	S271+ MX interface triple IR I.S. Flame Detector
517.001.266	S200+ Spares Kit & Sealant
517.001.263	S200+ Weather Protection Assembly
517.001.184	S200+ Detector Mounting Bracket

6.08

System 800 Addressable Fire Detection

System 800 Fire Detection for Hazardous Areas



Features

- Addressable I.S. MZX Technology
- Compatible with S271i+ flame detector
- Compatible I.S. callpoint.
- ATEX certified intrinsically safe Ex II 1 GD System
- Suitable for use in Zone 0, 1, 2, 20, 21 & 22

A complete range of ATEX and ITEX certified detectors suitable for use in Zone 0, 1, 2, 20, 21 & 22 Areas. MZX digital addressable for use on MZX Fire Controllers.

There is a risk of fire or explosion in all areas containing flammable substances in the form of liquids, gasses, dust or materials. Where these combustible materials are mixed with air in sufficient concentration they form a flammable atmosphere and the areas containing them are designated Hazardous Areas. When a source of ignition, such as a spark, is applied in a hazardous area, an explosion could take place. Electrical equipment supplied for use in Hazardous Areas must comply with requirements to ensure that its introduction into the area does not increase the existing risk. System 800 is an MX Technology Intrinsically Safe (I.S) system for use in Hazardous Areas which can be connected to the MX Fire Detection Systems installed in the Safe Areas.

The System designer must be familiar with ATEX certification and have successfully completed an appropriate recognised course in Intrinsic Safety. Design of the system requires that the designer has all the information concerning the installation correctly documented. The nature of the hazard must be defined by the customer and a survey carried out to determine the proximity of the safe area to establish cable runs.

The probability of a flammable mixture being present is defined by a zone number. Flammable gasses are classified in Groups and their minimum spontaneous ignition temperature is categorised by Class. Tyco Fire Protection Products supplied equipment marked EEx ia IIC T5 would be suitable for use in worst case conditions. E.G. Zone 0 (ia), Hydrogen (IIC), T5 (100 deg C). The Fire Alarm Equipment and Safety Barriers should be placed as near as possible to the containment wall of the Hazardous Area. This minimises the cable lengths between the barrier and the Hazardous Area and thus the capacity to store energy.

In order that an Installation will comply with the ATEX certification designated for each system, it is essential that the certified devices are connected with cables of the specified limits. These limits have been certified for specific classifications of hazard in order that energy storage is limited.

The number of devices connected to the barrier and located in the Hazardous Area must always be limited to not more than the listed maximum.

The use of the MX designer Software tool will ensure correct loop loading and it's use is essential to the design process.

System 800 is for use in MX Technology Addressable Fire detection circuits.

801PHEx Smoke and Heat Detector



The 801PHEx Optical Smoke & Heat Detectors form part of the 800Ex Series of MZX Addressable Fire Detectors. The detector plugs into the 5BEX base.

The mode of detector can be:

- Optical smoke only detector (sensitivity - High, Normal or Low)
- HPO smoke detector (sensitivity - High, Normal or Low)
- Heat only rate-of-rise (A1R) detector (no sensitivity selection)
- Heat fixed temperature 60°C (A2S no sensitivity selection)
- Optical (sensitivity - High, Normal or Low) combined with heat fixed temperature 60°C (A2S)
- HPO (sensitivity - High, Normal or Low) combined with heat fixed temperature 60°C (A2S)

Technical Information

Weight:	0.2 Kg detector and base (approx)
Operating Temp:	-25°C to +70°C
Storage Temp:	-40°C to +70°C
Relative Humidity:	95% non- condensing
ATEX Code:	BASA01ATEX1394X II 1GD CE 1180 EX la IIC T5 EX laD 20T100OC IECEX BAS 07.00-63X UI=28V II=93mA PI=0.65W CI=0= LI=0

Order Codes

516.800.530	801PHEx Optical Smoke + Heat Detector
--------------------	---------------------------------------

801CHEx CO & Heat Detector



The 801CHEx Carbon Monoxide plus Heat Detector form part of the 800Ex Series of MZX Addressable Fire Detectors. The detector plugs into the 5BEX base.

The mode of detector can be:

- Heat only detector (A1R or A2S) (sensitivity: - High, Normal or Low)
- Compensated Carbon Monoxide detector (sensitivity: - High, Normal or Low)
- Compensated Carbon Monoxide detector (sensitivity: - High or Normal) combined with heat (A1R)

Technical Information

Weight:	0.2 Kg detector and base (approx)
Operating Temp:	0°C to +55°C/ 20°C to +40°C
Storage Temp:	-20°C to +55°C
Relative Humidity:	95% non- condensing
ATEX Code:	BASA01ATEX1394X II 1GD CE 1180 EX la IIC T5 EX laD 20T100OC IECEX BAS 07.00-63X UI=28V II=93mA PI=0.65W CI=0= LI=0

Order Code

516.800.531	801CHEx Carbon Monoxide + Heat Detector
--------------------	---

6.10

System 800 Addressable Fire Detection

801HEx Heat Detector



The 801HEx Heat Detectors form part of the 800Ex Series of MZX Addressable Fire Detectors. The detector plugs into the 5BEX base.

The mode of detector can be:

- EN54-5 A1R, rate-of-rise normal ambient
- EN54-5 A2S, fixed 60°C
- EN54-5 CR, rate-of-rise high ambient

Technical Information

Weight:	0.2Kg detector and base (approx)
Operating Temp:	-25°C to +70°C
Storage Temp:	-40°C to +70°C -40°C to +80°C
Relative Humidity:	95% non- condensing
ATEX Code:	BASA01ATEX1394X II 1GD CE 1180 EX Ia IIC T5 EX IaD 20T100OC IECEX BAS 07.00-63X UI=28V II=93mA PI=0.65W CI=0= LI=0

Order Code

516.800.532 801HEx Heat Detector

801FEx Flame Detector



The 801FEx point type flame detector forms part of the MZX Technology range of digital addressable fire detectors. The detector plugs into the 5BEX base.

The 801FEx is a full featured solar blind flame detector and can detect a 0.1m² fire at a range of 20 m.

The mode of detector can be:

Technical Information

Weight:	0.2 Kg detector and base (approx)
Operating Temp:	-20°C to +70°C
Storage Temp:	-40°C to +80°C
Relative Humidity:	95% non- condensing
ATEX Code:	BASA01ATEX1394X II 1GD CE 1180 EX Ia IIC T5 EX IaD 20T100OC IECEX BAS 07.00-63X UI=28V II=93mA PI=0.65W CI=0= LI=0

Order Codes

516.800.066 801FEx I.R. Flame Detector
516.800.067 811FEx Marine I.R. Flame Detector

CP840Ex Break Glass Callpoint



The CP840Ex Weatherproof Break Glass Callpoint is designed to monitor and signal the condition of a switch contact associated with the break glass.

Technical Information

Operating Temp:	-25°C to +70°C
Storage Temp:	-30°C to +70°C
Relative Humidity:	95% non- condensing
ATEX Code:	BASA01ATEX1394X II 1GD CE 1180 EX Ia IIC T5 EX IaD 20 T100OC IECEX BAS 07.00-63X UI=28V II=93mA PI=0.65W CI=0= LI=0

Order Code

514.800.513	CP840Ex MZX Digital Addressable Break Glass Callpoint
-------------	---

IF800Ex Interface Module



The Intrinsically Safe IF800EX Interface Module is designed to monitor fire contacts such as sprinkler flow switches. The IF800Ex is contained within a grey compression moulded glass filled polyester box with 2 x 20mm cable gland holes.

The electronic components are mounted on a double sided printed circuit board built into a potted module formed from a plastic moulding. Connectivity is via two terminal blocks fitted to the PCB.

Technical Information

ATEX Code:	BASA01ATEX1394X II 1GD CE 1180 EX Ia IIC T5 EX IaD 20 T100OC IECEX BAS 07.00-63X UI=28V II=93mA PI=0.65W CI=0= LI=0
------------	---

Order Code

514.001.062	IF800Ex MZX Digital Addressable Interface Module Assembly
-------------	---

6.12

System 800 Addressable Fire Detection

EXI800 Interface Module & Galvanic Isolators



The EXI800 Interface Module when used with a galvanic isolator, provides a path for an MZX panel to transparently communicate to slave devices (800Ex Detectors, IF800Ex Interface Module or CP840Ex Addressable Break Glass Call Point) connected to the Intrinsically Safe Loop. The EXI800 interface reduces the standard MZX loop supply voltage and signalling currents to levels that are acceptable for hazardous areas. The EXI800 can detect a short circuit on the left-loop, the right-loop, or the IS spur and will isolate the offending circuit from the other loop connections.

The IS loop output of the EXI800 interfaces with the Pepperl & Fuchs KFDO-CS-Ex1.54 Galvanic Isolator supplying loop voltage and signalling currents to the Intrinsically Safe Loop. Both single channel and dual channel Galvanic Isolators are available.

Order Codes

- 514.001.063 EXI800 Interface Module
- 517.001.306 Single channel KFDO-CS-EX1.54 Galvanic Isolator
- 517.001.305 Two channel KFDO-CS-EX2.54 Galvanic Isolator
- 517.001.304 MTL5525 I.S. Sounder Driver

The EXI800 is supplied complete with a service tool EX dongle that is required to activate the address programming when using the standard MZX service tool. The MTL5525 Isolating Sounder Driver enables an intrinsically safe sounder located in the hazardous area, to be controlled from the safe area. The MTL5525 has one channel and is suitable for connecting certified loads in Zone 0, IIC, T4-T6 hazardous areas.

IS Barrier Enclosure



The MTL 'DX' Series enclosures will house the EXI800 (20 mm pitch), Pepperl & Fuchs KFDO-CS-Ex1.54 Galvanic Isolator (20 mm pitch) and the MTL5525 I.S. Sounder Driver (16.2 mm pitch). The units are DIN rail mounted with 70 mm of rail supplied with the DX070 and 170 mm of rail with the DX170. The enclosures are usually selected on the number of units they will accommodate. The following table shows the capacity of each of the enclosure types.

Order Codes

- 517.001.248 DX070 Enclosure
- 517.001.247 DX170 Enclosure

Enclosure	MTL5500 isolators 16.2mm Pitch	MTL7700 barriers 7.5mm Pitch
DX070	4 (2*)	9 (5*)
DX170	10 (8*)	22 (18*)

* Use these figures when two IMB57 mounting brackets for tagging/earth rail accessories are included.

BG MIM800 Callpoint EX II 2 GD

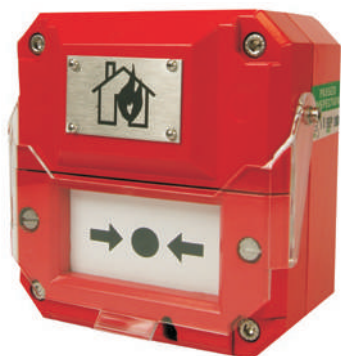

An Ex II 2 GD Dust Approved & Increased Safety (EExemd) Resettable Manual Alarm Call Point for use with the EExd Flameproof MIM800 input module in EExd housing on an Addressable Detection & Releasing System in gas and dust explosive risks.

Please note that the above part is only compatible with Consys Version 17.0 and above when used with 577.800.067.

Features

- Glass Reinforced Polyester Enclosure – light, strong and not subject to corrosion
- Resettable Element
- Explosion protected EExe (ATEX Approved)
- In line and end of line resistors
- Red Epoxy Finish
- 7 x terminals
- Lift flap for extra protection against inadvertent operation
- 1 x changeover switch
- Captive cover screws
- Key operated test facility – simple but secure
- 1 x M20 bottom cable entry

Order Code

514.001.107 EX II 2 GD Dust Approved & Increased Safety (EExemd) Resettable Manual Alarm Callpoint

Technical Information

Protection:	Explosion Protected EExed (Increased Safety)
Voltage:	Up to 250 V
Certified Temperature:	-20°C to +50°C
Ingress Protection:	IP66 & IP67
Terminals:	7 x 2.5 mm ²
Switch Ratings (1 x Changeover):	DC 0-30 V 5 A (Resistive) or 3 A (Inductive) DC 30-50 V 1 A Resistive or Inductive AC 0-254 V 5 A Resistive or Inductive
Cable Entries:	1 x M20 Bottom
Weight:	1.2 Kg
Material:	Anti Static U.V. Resistant Glass Reinforced Polyester
Finish:	Red Epoxy Paint
Resistors:	Alarm: 100 Ohm EOL: 250 Ohm
Labelling:	Burning House Symbol
Dimensions:	126H x 120W x 75D mm
Certification:	ATEX approved Ex II 2 GD BAS02ATEX2105X EExemdIICT4 CENELEC EN50014 EN50019 EN50018 EN50028 Suitable for use in Zones 1 & 2

6.14

System 800 Addressable Fire Detection

BG MIM800 Callpoint EX II 2 GD



An EExd Flameproof MIM800 Addressable Module for extending the monitoring of Call Points and other Alarm Inputs on an MZX, ZX and MZX Addressable System in gas and dust explosive risks.

Please note that the above part is only compatible with Consys Version 17.0 and above when used with 514.001.107.

Features

- Copper Free Metal Alloy Aluminium Housing
- Explosion Protected to EExd (ATEX Approved)
- 9 x Terminals
- 3 x M20 Cable Entries
- Fast Interrupt Mode for Call Points

Technical Information

Protection:	Explosion Protected EExd (Flameproof)
Voltage:	40Vdc
Certified Temperature:	-20°C to +55°C
Ingress Protection:	IP67
Terminals:	9 x 2.5 mm ²
Cable Entries:	3 x M20 (No Blanking Plugs)
Weight:	0.8 Kg
Material:	Metal Alloy Aluminium - Copper Free
Dimensions:	98H x 108W x 90D mm
Certification:	Ex II 2 GD LOM02ATEX2037 EExdIICT6 CENELEC EN50014 EN50018 EN50019 EN50281-1-1 EN60439-1 Suitable for use in Zones 1 and 2 to IEC 60079-10 Suitable for use in Zones 21 and 22 to EN50281-3

Order Code

577.800.067 MIM800 Input Module in EExd Housing

System 620 Fire Detection for Hazardous Areas



Features

- Conventional I.S. system
- Suitable for worst case (EEx ia IIC T5)
- High Performance Optical (HPO) smoke detector
- Compatible with S231i+ flame detector
- Compatible I.S. callpoint
- Suitable for use in Zone 0,1,2,20,21 & 22

A complete range of ATEX and ITEX certified detectors suitable for use in Zones 0,1,2,20,21 & 22 areas for use on conventional panels. There is a risk of fire or explosion in all areas containing flammable substances in the form of liquids, gasses, dust or materials. Where these combustible materials are mixed with air in sufficient concentration they form a flammable atmosphere and the areas containing them are designated Hazardous Areas. When a source of ignition, such as a spark, is applied in a hazardous area, an explosion could take place. Electrical equipment supplied for use in Hazardous Areas must comply with requirements to ensure that its introduction into the area does not increase the existing risk. System 620 is an Intrinsically Safe (I.S.) system for use in Hazardous Areas which can be connected to a conventional fire Alarm Controller installed in the Safe Area.

The System Designer must be familiar with ATEX certification and have successfully completed an appropriate recognised course in Intrinsic Safety. Design of the system requires that the designer has all the information concerning the installation correctly documented. The nature of the hazard must be defined by the customer and a survey carried out to determine the proximity of the safe area to establish cable runs.

The probability of a flammable mixture being present is defined by a Zone Number. Flammable gases are classified in Groups and their minimum spontaneous ignition temperature is categorised by Class. ZETTLER products supplied equipment marked EEx ia IIC T5 would be suitable for use in worst case conditions. Eg. Zone 0 (ia), Hydrogen (IIC), T5 (100 deg C). The Fire Alarm Equipment and Safety Barriers should be placed as near as possible to the containment wall of the Hazardous Area. This minimises the cable lengths between the barrier and the Hazardous Area and thus the capacity to store energy.

In order that an Installation will comply with the ATEX certification designated for each system it is essential that the certified devices are connected with cables of the specified limits. These limits have been certified for specific classifications of hazard in order that energy storage is limited.

The number of devices connected to the barrier and located in the Hazardous Area must always be limited to not more than the listed maximum.

When a mixture of devices is connected to any one zone the numbers must be reduced in proportion to the ratio of the load presented to the barrier. When a System includes the use of an S231i+, it must be remembered that the load it presents to the circuit is twice that of a detector. A mixture of large and small load devices connected to a zone will require a calculation for the number of allowed detectors.

System 620

System 620 is for use in conventional fire detection circuits. Two Sounder Systems, (one earthed and one isolated), are available and either can be used with System 620.

6.16

System 620 Conventional Fire Detection

MR601TEx High Performance Optical Smoke



The MR601TEX has been developed to overcome the slower response of the optical detectors to hot burning fires, by increasing the sensitivity of the optical detector when it is associated with a rapid change in temperature. In this way it is intended to become a detector which can cover some of the risks currently covered by ion chamber detectors. Smoke detectors will not detect burning alcohol or other clean burning liquids which do not generate smoke particles.

Technical Information

Operating Temp:	-20°C to +70°C
Storage Temp:	-25°C to +80°C
Relative Humidity:	95% non-condensing
ATEX Code:	Ex II 1GD
Cenelec Code:	Ex ia IIC T5/ Ex iaD 20 T100°C

Order Code

516.054.011.Y	MR601TEX Conventional High Performance Optical Smoke Detector
---------------	---

MD601Ex & MD611Ex Heat Detectors



If environmental conditions rule out the use of smoke detectors, then a heat detector of the type MD601Ex/MD611Ex may provide an acceptable, though less sensitive, alternative. For general use, and particularly where the ambient temperature may be low, a 'Rate-of-Rise' heat sensor is to be preferred. This type of sensor reacts to abnormally high rates of change of temperature and provides the fastest response over a wide range of ambient temperatures. A fixed temperature limit is also incorporated in these detectors. In many environments, e.g. kitchens and boiler rooms, sudden, large changes in temperature are considered 'normal'. Rate-of-rise detectors are generally not suitable in these cases and fixed temperature [static] types should be used.

Technical Information

Operating Temp:	-20°C to +70°C
Storage Temp:	-25°C to +80°C
Relative Humidity:	95% non-condensing
ATEX Code:	Ex II 1GD
Cenelec Code:	Ex ia IIC T5/ Ex iaD 20 T100°C

Order Codes

516.052.051.Y	MD601EX Conventional Rate of Rise Heat Detector
516.052.041.Y	MD611EX Conventional Fixed Temperature Heat Detector

MDU601Ex Enhanced Carbon Monoxide Fire & Heat Detector



The MDU601EX detector is a combined CO and Rate of Rise Heat Detector where the sensitivity of the CO detector is enhanced in response to a fast rate of change of temperature.

Technical Information

Operating Temp:	-10°C to +55°C
Storage Temp:	-20°C to +55°C
Relative Humidity:	90% non-condensing
ATEX Code:	Ex II 1GD
Cenelec Code:	Ex ia IIC T5/ Ex iaD 20T100°C

Order Code

516.061.001.Y	MDU601EX Enhanced Carbon Monoxide Fire & Heat Detector
---------------	--

601FEx & 601FEx-M Ex Flame Detectors



Flame detectors, unlike smoke and heat detectors, do not rely on convection to transport the fire products to the detector nor do they rely on a ceiling to trap the products. They can therefore be used to protect large open areas without sacrificing speed of response to flaming fires. In order to ensure full coverage however, flame detectors do require direct line of sight to all parts of the protected area.

Infra-red flame detectors such as the 601FEx are designed to respond rapidly to fires which involve clean-burning fuels such as alcohol or methane, i.e. fires which would not be detected by smoke detectors.

Technical Information

Operating Temp:	-20°C to +70°C
Storage Temp:	-40°C to +80°C
Relative Humidity:	90% non-condensing
ATEX Code:	Ex II 1GD
Cenelec Code:	Ex ia IIC T4/ Ex iaD 20T135°C

Order Codes

516.600.066	601FEx Infra-Red Flame Detector
516.600.067	601FEx-M Infra-Red Flame Detector (Marine)

The 601FEx Flame Sensor, by virtue of its operating wavelength and flicker discrimination is insensitive to normal environmental influences. For outdoor use a solar-blind detector [e.g. the S200 Plus] should be used. The 601FEx Flame detector should, normally, only be used inside buildings to supplement heat and smoke detectors.

6.18

System 620 Conventional Fire Detection

5BEX Detector Base and Ancillaries



Technical Information

Operating Temp:	-25°C to +70°C
Storage Temp:	-40°C to +80°C
Relative Humidity:	95% non-condensing
ATEX Code:	Ex II 1GD
Cenelec Code:	Ex ia IIC T5/ Ex iaD 20 T100°C

Order Codes

517.050.023	5BEX 5" Universal Ex Base
517.050.603	DHM-5B deckhead mounting
517.001.120	System 601 EOL Unit (Pk 10)

BG Conventional Callpoint EX II 2 GD

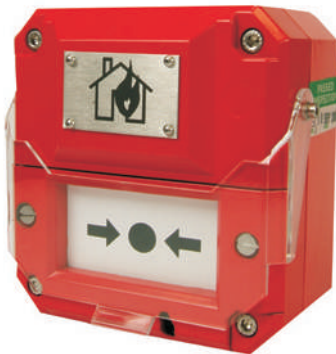

This EX II 2 GD Dust Approved & Increased Safety (EExemd) Conventional Break Glass Manual Alarm Call Point is fitted with a 470 ohm Alarm Level Resistor and a 4K7 ohm EOL Resistor for use with Tyco Conventional Detection Circuits including the DIM800 and DDM800 MZX Modules.

The unit's housing is made of polyester, therefore making it light, strong and not subject to corrosion.

No hammer is required to operate this callpoint. The glass is covered by a membrane, thus protecting the operator from glass fragments.

It is also fitted with a removable link which allows it to be connected on its own or with other Conventional Devices to a Tyco Conventional Detection Circuit.

Order Code

514.001.108	EX II 2 GD Dust Approved & Increased Safety (EExemd) Conventional Break Glass Manual Alarm Callpoint
-------------	--

Features

- Polyester Enclosure
- Explosion protected EExe (ATEX Approved)
- In line and end of line resistors
- 9 x terminals
- Lift flap for protection against inadvertent operation
- 1 x changeover switch
- Captive cover screws
- No hammer required
- Key operated test facility – simple but secure
- 2 x M20 bottom cable entries

Technical Information

Protection:	Explosion Protected EExed (Increased Safety)
Voltage:	Up to 250 V
Certified Temp:	-20°C to +50°C
Ingress Protection:	IP66 & IP67
Terminals:	9 x 2.5 mm – up to 60 V
Switch Ratings (1 x Changeover):	DC 0-30 V 5 A (Resistive) or 3 A (Inductive) 30-50 1 A Resistive or Inductive AC 0-254 V 5 A Resistive or Inductive
Cable Entries:	2 x M20 Bottom
Weight:	1.2 Kg
Material:	Anti Static U.V. Resistant Glass Reinforced Polyester
Finish:	Red Epoxy Paint
Resistors:	Alarm: 470 Ohm EOL: 4K7 Ohm
Labelling:	Burning House Symbol
Certification:	ATEX approved Ex II 2 GD BAS02ATEX2105X EExedmIICT4 CENELEC EN50014 EN50019 / EN50018 / EN50028 Suitable for use in Zones 1 & 2

BG3 I.S. Conventional Callpoint - Atex Approved



This manual fire alarm call point is designed in accordance with the latest European Callpoint Standard (EN54-11).

Weatherproof to IP66/IP67 and available certified intrinsically safe, simple apparatus manufactured from glass reinforced polyester (GRP) which provides a robust, corrosion free construction and ensures effective and reliable operation in harsh industrial and offshore environments.

Units are supplied in self coloured GRP with a 'Burning House' duty label as standard.

Features

- Intrinsically safe
- Weatherproof to IP66/IP67
- Robust GRP Housing

Technical Information

Model:	BG3I
Protection:	Explosion Protected EExia (Intrinsically Safe)
Voltage:	Up to 28 V (IS)
Certified Temp:	-55°C to +55°C
Ingress Protection:	IP66 & IP67
European Standard for Callpoints:	EN54-11
Terminals:	6 X 4.0 mm ²
Cable Entries:	2 X M20 Bottom
Weight:	0.5 Kg
Material:	UV resistant glass reinforced polyester
Finish:	Natural Red GRP
Certification:	CENELEC EN50014, 020 BASEEFA EExia IIC T4 Cert No. BAS00ATEX1067X Suitable for use in Zones 0,1 & 2

Order Code

514.001.059 Intrinsically Safe Callpoint (BG3I4NBN)

MCP220Ex I.S. Callpoint - ATEX Approved



The MCP220Ex is an intrinsically safe conventional callpoint for use on the ATEX Certified System.

Features

- Intrinsically Safe
- Weatherproof to IP67
- Compatible with System 620

Technical Information

Dimensions:	93H x 98W x 66D mm
Weight:	270 g
Material:	PC/ABS
Colour:	Red
IP Rating:	IP67
ATEX Code:	Ex II 1GD
Cenelec Code:	EX ia IIC T4 Ga /EX iaDT135°C Da
ATEX Cert:	SIRA 06ATEX2131X

Order Code

514.001.109 MCP220Ex Red Callpoint intrinsically safe for use with ATEX certified conventional system 620.

6.20

Intrinsically Safe Sounders

DB3B Flameproof Horn Sounder



This lightweight all GRP flameproof sounder is intended for use in potentially explosive gas and dust atmospheres and has been designed with high ingress protection to cope with the harsh environmental conditions found offshore and onshore in the oil, gas and petrochemical industries.

The flamepaths, flare and body, are manufactured completely from a UV stable glass reinforced polyester. Stainless steel screws and sinter are incorporated thus ensuring a corrosion free product. A tapered flamepath is used to overcome the problems of assembly of parallel spigot flamepaths.

Features

- For use in hazardous areas
- Robust GRP construction
- Powerful Output, up to 122dBA

Technical Information

Voltage:	12 VDC to 48 VDC
Certified Temp:	-55°C to +70°C
Weight:	6.0kg approx
Terminals:	6 x 2.5mm ²
Mounting:	Stainless steel bracket with ratchet facility
Cable Entries:	2 x 20 mm EExd.
Tone Selection:	27 user selectable tones.
Material:	Body & horn in anti-static, UV stable, glass reinforced polyester. Swivel bracket & captive cover screws in stainless steel.
Ingress Protection:	IP66 & IP67/NEMA 4X & 6
Certification:	ATEX Ex d Gas & Dust Cert. no. Baseefa13ATEX0231X. Certified to: EN60079-0,1,31Ex II 2GD, Ex d IIC T4/T5/T6 Gb, Ex tb IIIC T135°C/T100°C/T85°C Db, IP66

Order Code

DB3BDGD048N2BNR DB3B Flameproof Horn Sounder

XB8 Intrinsically Safe Beacon



This ruggedised, intrinsically safe and weatherproof beacon is intended for use in potentially explosive atmospheres, and has been designed with high ingress protection to cope with the harsh environmental conditions found offshore and onshore in the oil, gas and petrochemical industries.

Please refer to MEDC for guidance on cable capacitance and barriers.

Please Note:

This beacon should be used for supplementary indication purposes only. In this case the device is not required to be used as a Visual Alarm Device (VAD) and EN54-23 is not relevant to its classification.

Features

- Copper Free Metal Alloy Aluminium Housing
- Explosion Protected to EExd (ATEX Approved)
- 9 x Terminals
- 3 x M20 Cable Entries
- Fast Interrupt Mode for Call Points

Technical Information

Flash Rate:	1 flash per second
Certified Temp:	-55°C to + 60°C
Weight:	1.4 kg
Voltage:	24 V via suitable barrier
Current Consumption:	71 mA max nominal
Terminals:	8 x 2.5 mm ²
Tube Type:	Xenon discharge
Tube Energy:	0.5 Joules
Tube Life:	>1 x 106 Flashes
Lens Colour:	Clear
Material:	UV stable glass reinforced polyester body. Clear polycarbonate cover/lens. Retained stainless steel cover screws.
Finish:	Painted Red
Ingress Protection:	IP66 & IP67
Cable Entries:	Up to 3 x M20 via knockouts
Certification:	CENELEC EN50014, 20 & 39 BAS02ATEX1258X EExia IIB T4 Zones 0,1 & 2

Order Code

540.001.038 Intrinsically Safe Xenon Beacon
(XB8BB024CNR)

6.22

Intrinsically Safe Beacons

XB11 Flameproof Xenon Beacon



These certified beacons have been designed for use in potentially explosive gas and dust atmospheres and harsh environmental conditions. The glass reinforced polyester enclosures are suitable for use offshore or onshore, where light weight combined with corrosion resistance is required.

The beacon housing is manufactured completely from a U.V. stable, glass reinforced polyester. Stainless steel screws and mounting bracket are incorporated ensuring a totally corrosion free product.

Please Note:

This beacon should be used for supplementary indication purposes only. In this case the device is not required to be used as a Visual Alarm Device (VAD) and EN54-23 is not relevant to its classification.

Features

- Robust Corrosion Resistant GRP body
- High Power (5 Joule)
- Certificated Flameproof

Technical Information

Voltage:	24 Vdc
Peak Current	
Consumption:	320 mA
Power Consumption:	8W
Tube Energy:	5 Joules
Effective Intensity:	29 Cd
Peak Intensity:	22213 Cd
Note:	The Cd figures are for a clear lens @ 1Hz flash rate. For red lens multiple by 0.15.
Certified Temp:	EExd -55°C to +70°C (T4) -55°C to + 55°C (T5) -55°C to + 40°C (T6)
Weight:	2.5Kg
Body Material:	Glass reinforced polyester
Lens Material:	Glass
Cover Screws & Backstrap:	Stainless steel 316
Finish:	Red
Ingress Protection:	IP66 & IP67
Terminals:	6 x 2.5 mm ²
Entries:	2 x 20 mm ISO EExd.
Certification:	BASEEFA EExd IIB 135°C (-55 to AMB +70°C)T4 100°C (-55 to AMB + 55°C)T5 85°C (-55 to AMB + 40°C)T6 Cert. No. 99 ATEX 2195X CENELEC EN50014 and EN50018

Order Code

540.001.039

Flameproof Xenon Beacon
(XB11B02406RNBNNR)

Intrinsically Safe Barriers - Atex Approved

The following section relates to a range of intrinsically safe barrier and isolator equipment for use with ZETTLER fire detection systems. It essentially encompasses the relevant MTL5500 and MTL7700 series barriers plus the associated housing options as an alternative to existing MTL700 series equipment.

On all issues of intrinsically safe system design, please refer to Manual 26A for guidance.

Galvanic Isolators - MTL5500



The MTL5561 is a two channel interface for use with conventional detectors located in hazardous areas. This galvanic isolator is CE marked, and replaces the MTL3043 barrier option. It is suitable for connecting loads in Zone 0, IIC, T4-T6 hazardous areas if suitably certified.

The MTL5525 Isolating Sounder Driver enables an intrinsically safe sounder located in the hazardous area, to be controlled from the safe area.

Order Codes

517.001.302	MTL5561 2 Channel Galvanic Isolator
517.001.304	MTL5525 I.S. Sounder Driver

The MTL5525 barrier is designed as a CE marked replacement for the existing MTL3021 barrier. It has one channel and is suitable for connecting loads in Zone 0, IIC, T4-T6 hazardous areas if suitably certified.

When designing new systems or upgrading existing MTL3000 series systems to MTL5500 series, please use the appropriate MTL "DX" series enclosure equipment (16.2mm pitch).

Zener Barriers - MTL7700



The MTL7700 Series intrinsically safe shunt-diode safety barriers are innovative devices designed to provide exceptionally high packing densities, straightforward installation and simplified connection, commissioning and maintenance facilities. The MTL7700 Series include secondary replaceable fuses. These are useful where there is the possibility of faults occurring during commissioning, which would otherwise blow the barriers' internal safety fuses.

One secondary replaceable fuse for each barrier channel is provided and is lower in value than the safety related fuse. Fuses are packaged in small mouldings which can be latched in a disconnect position to break the safe and hazardous areas during commissioning, maintenance and fault finding, thus avoiding the need for additional disconnect terminals.

Order Codes

517.001.301	MTL7728 + Zener Safety Barrier for conventional detection circuits designed in accordance with System 601
546.004.005	Intrinsically safe sounder circuit interface module

Please note: This barrier is a direct alternative for the MTL728+ barrier.

6.24

Safety Enclosures

UC Series Enclosures



The UC series of enclosures provides a simple but effective means of mounting and protecting the MTL3000 series units, in safe areas. A standard lightweight enclosure with transparent lid, which can accommodate 4 units. The polycarbonate enclosure is impact resistant, flame retardant and dustproof to IP65.

Order Code

517.001.196 UC2 4 Way Barrier Housing

MT Series Enclosures



The MT series of enclosures provides a simple, effective means of mounting and protecting MTL700 Series barriers in safe areas or low-risk hazardous areas. Three lightweight polycarbonate enclosures with see through lids accommodate up to 2, 5 and 12 barriers in the safe area. All the enclosures are supplied ready fitted with a nickel plated brass busbar mount, so barriers can be installed and wired up immediately without special tools.

Order Codes

517.001.198 MT2 2 Way Zener Barrier Housing
517.001.199 MT5 5 Way Zener Barrier Housing
517.001.200 MT12 12 Way Zener Barrier Housing

Ancillaries



The ERL7 earth rail is a nickel plated 3 x 10mm rail (1 metre long), suitable for a do-it-yourself mounting arrangement. It will accommodate up to 2.5 ETM7 earth terminals per barrier location for terminating earth returns and cable screens from the hazardous area.

The IMB7 mounts on a flat surface or top hat rail (35mm) or G-profile rail and acts as a convenient method for mounting the earth busbar.

Order Codes

517.001.205 ERL7 Earth rail for I.S. systems
517.001.206 ETM7 Earth termination connection system
517.001.207 IMB7 Insulating mounting block



Detector Test Equipment

Testifier
Scorpion

Solo

Flame Detector Testers

7.02

Testifier Detector Test Equipment

Testifier Detector Test Equipment



Testifire is the world's first 3 in 1 detector tester. Suitable for single and multi-sensor detectors, it enables functional testing of Smoke, Heat and CO and offers a wide range of benefits over existing test tools.





Features

- Smoke, Heat & CO in one unit*
- Independent, simultaneous or sequential testing
- Clearing mode
- Capsule generated stimuli
- 'Hi Heat' setting for sensors up to 100°C

Benefits

- Increases productivity on site
- Compatible with widest range of detectors
- Controlled stimuli release prevents damage to the detector
- Non-pressurised capsules eliminate environmental concerns
- Designed for use with Solo Access poles

* CO available on Testifire 2001

	Description	Order Codes
	Testifire Smoke, Heat & CO Detector Test Kit 2001 1 x Testifire Smoke, Heat & CO Detector Tester 1 x Testifire Smoke Capsule 1 x Testifire CO Capsule 2 x Solo 770 Battery Batons (517.001.273) 1 x Solo 727 Battery Charger (517.001.274)	517.001.276
	Testifire Smoke and Heat Detector Tester Kit 1001 1 x Testifire Smoke and Heat Detector Tester 1 x Testifire Smoke Capsule 2 x SOLO 770 Battery Batons (517.001.273) 1 x SOLO 727 Battery Charger (517.001.274)	517.001.267
	Smoke Capsules 6 x Testifier TS3 Replacement smoke capsules	517.001.237
	CO Capsules 6 x Replacement CO capsules (For use with Testifire 2001)	517.001.238

Scorpion Detector Test Equipment





Scorpion is an innovative solution for functionally testing any hard-to access smoke detector.

A Scorpion head unit is a smoke generator which is installed next to the point detector or at the furthest sampling hole of an ASD pipe and when required, generates smoke for a functional test of the device.

A test that would have taken hours in planning, risk assessments and execution, is now completed in a matter of minutes and is as easy as testing a detector within reach.

Ideally suited for:

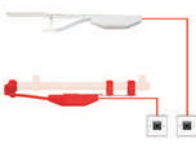
- Lift Shafts
- Ceiling and Floor Voids
- Secure Areas (e.g. Plant / Storage / Server room)
- Hazardous Areas

	Description	Order Codes
	<p>Scorpion Point Installation Kit Includes: 1 x Scorpion Point Head Unit, 1 x Scorpion Access Point</p>	517.001.270
	<p>Scorpion ASD Installation Kit Includes: 1 x Scorpion ASD head Unit, 1 x Scorpion Access Point</p>	517.001.271
	<p>Scorpion Engineer's Controller Controls Scorpion Head Unit via connection to Scorpion Access Point</p>	517.001.272

7.04

Solo Detector Test Equipment

Solo Detector Test Equipment



	Description	Order Codes
	<p>Aerosol Dispenser for Solo Smoke and Test Aerosols</p> <ul style="list-style-type: none">1 x Testifire Smoke, Heat & CO Detector Tester1 x Testifire Smoke Capsule1 x Testifire CO Capsule2 x Solo 770 Battery Batons 517.001.2731 x Solo 727 Battery Charger 517.001.274	517.001.236
	<p>Solo A10 Smoke Detector Test Aerosol</p> <ul style="list-style-type: none">• Designed for use with Solo Dispenser• Non-flammable• Fast activation• Fast clearing <p>Solo A10s-001 250ml can Solo A10-001 150ml can</p>	517.001.279 517.001.280
	<p>Solo C3 CO Detector Test Aerosol</p> <ul style="list-style-type: none">• Designed for use with Solo Dispenser• Genuine, non-flammable CO stimulus• Controlled delivery	517.001.262
	<p>Solo 461 Cordless Heat Detector Test Kit</p> <ul style="list-style-type: none">• Battery powered• Suits fixed temperature, rate of rise and combination detectors up to 90°C• Lightweight and simple to use• Universal design suits wide range of detectors• Designed for use with Solo Access Poles <p>Includes:</p> <ul style="list-style-type: none">1 x Solo Heat Detector Tester1 x Solo 727 Battery Charger 517.001.2742 x Solo 770 Battery Batons 517.001.273	517.001.254
	<p>Solo 770</p> <p>3.0Ah NiMH Battery Baton for use with Testifire, Solo 461 and Scorpion</p>	517.001.273
	<p>Solo 727</p> <p>Charger for use with 3.0Ah Solo 770 Battery Batons</p>	517.001.274

	Description	Order Codes
	<p>Solo 200 Detector Removal Tool</p> <ul style="list-style-type: none"> • Universal design suits wide range of detectors • Designed for use with Solo Access Poles 	<p>517.001.240</p>
	<p>800RT Detector Removal Tool</p> <ul style="list-style-type: none"> • Compatible with 800 and 600 series detectors • Enables detector dust covers to be removed 	<p>516.800.917</p>
	<p>Storage Bag A protective storage bag for the Solo and Testifire product ranges</p>	<p>517.001.264</p>
	<p>Solo 100 Telescopic Access Pole 3 section Telescopic Pole extends from 1.26 to 4.5 metres</p>	<p>517.001.230</p>
	<p>Solo 108 Telescopic Access Pole 2 section Telescopic Pole extends from 1.2 to 2.2 metres</p>	<p>517.001.275</p>
	<p>Solo 101 Extension Pole 1.13 metre Extension Pole which can be used on its own or fitted to a Solo Telescopic Pole</p>	<p>517.001.226</p>
	<p>Adaptor Tube B Adaptor for Solo Access Poles to allow fitting of:</p> <ul style="list-style-type: none"> • 800RT Detector Removal Tool (516.800.917) • T110 Flame Detector Tester (592.001.012) • T210+ Flame Detector Tester (592.001.016) • M900 Address Key Extractor Tool (517.001.235) 	<p>517.001.224</p>
	<p>M900 Address Key Extractor Tool The address key extractor tool can be used to remove the address key from either a 4" or 5" detector base from ground level</p>	<p>517.001.235</p>

7.06

Solo Detector Test Equipment

517.001.237
Smoke Capsules

517.001.237
Smoke Capsules

517.001.238
CO Capsules



OR

OR

517.001.256
Smoke Detector Tester



517.001.262
CO Detector Tester



AND



517.001.236
Testfire Smoke, Heat & CO Detector Tester

517.001.267
Testfire Smoke & Heat Detector Tester

517.001.255
Solo Smoke & CO Aerosol Dispenser

517.001.254
Solo Heat Detector Tester

517.001.240
Solo Universal Removal Tool

592.001.012
592.001.016
Flame Detector Testers

516.800.917
Detector Removal Tool

517.001.235
Address Key Extractor Tool

- Solo Battery Baton 517.001.226** For use with:
- Smoke, Heat & CO Detector Test Kit 517.001.236
 - Smoke & Heat Detector Test Kit 517.001.267
 - Cordless Heat Detector Test Kit 517.001.254
 - Smoke, Heat & CO Detector Test Kit 517.001.236

517.001.224
Adapter Tube B

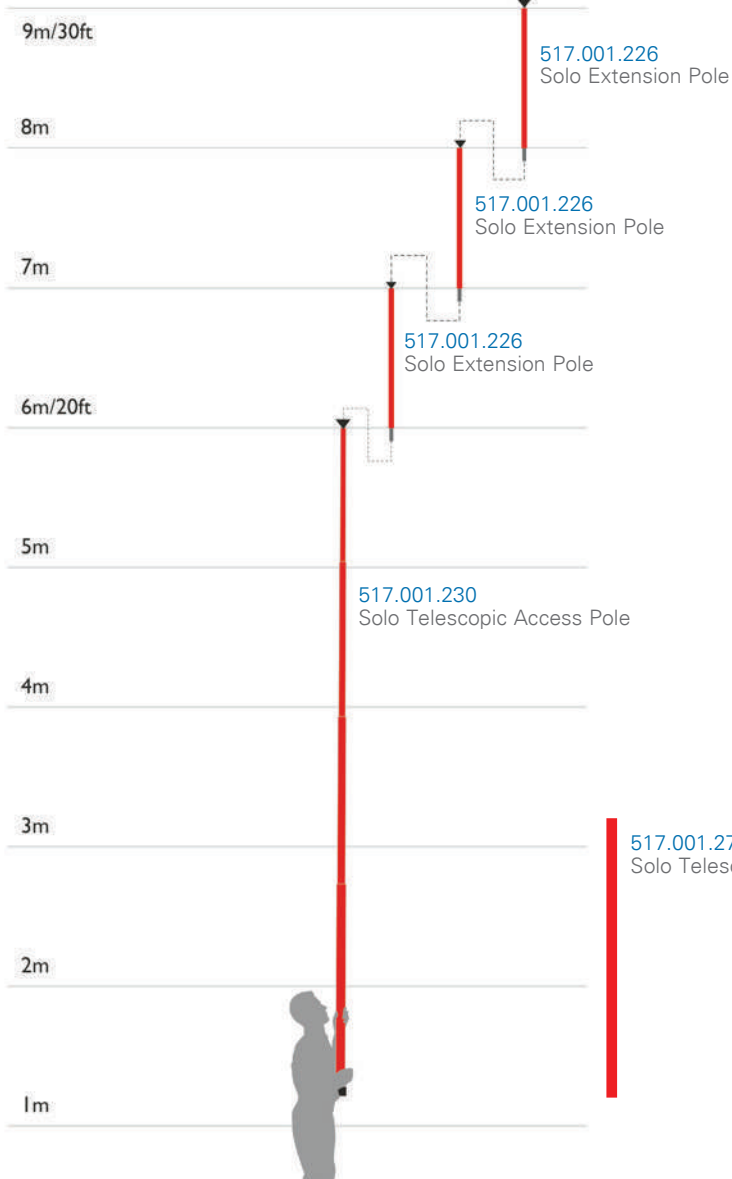

Scorpion - for ASD and hard-to-access Point Detectors

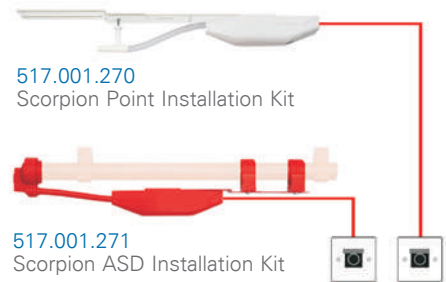

517.001.272
Scorpion Engineer's Controller

Part No.	Access Height (approx. max.)
517.001.275	4 m
517.001.230	6 m
517.001.230 + 517.001.226 (x1)	7 m
517.001.230 + 517.001.226 (x2)	8 m
517.001.230 + 517.001.226 (x3)	9 m

T210+ Test Source Flame Detector Tester



Features

- Approved for use in zone 1 & 2 areas (GPIIC gases)
- Adaptor plate to ensure perfect alignment
- IECEX Approved



Technical Information

Material	Glass filled polyester
Weight	0.8 kg
Supply Voltage	9 Vdc
Operating Temp	-10°C to + 50°C
Humidity	95% (Non Condensing)
Enclosure	IP54
Classification	Atex EExe ib IICT4. Suitable for use in zones 1 & 2 where group IIC gases or lesser hazards are sometimes present in explosive concentrations.

Order Codes

592.001.016	T210+ Test source for use with Solo 704 Adaptor Tube B (517.001.224) and Solo 100/101 Poles (517.001.230/226)
592.001.014	T210+Adaptor required for the T210+ to be used with S200 and S200 Plus Flame Detectors
592.001.010	T110 PP3 Battery and Charger Kit

Other Flame Detector Tester Equipment

	Description	Order Codes
	T110 Test Source for use with Solo 704 adaptor tube B (517.001.224) and Solo 100/101 poles (517.001.230/226)	592.001.012
	T110 Adaptor for series 600 and 800 Flame Detectors	592.001.018



Emergency Voice Communication (EVC)

Omnicare Loop Wired EVC
CARE2 Radial Wired EVC

8.02

Fire Telephones, Disabled Refuge & Toilet Alarm

Omnicare - Loop Wired Emergency Voice Communication



Features

- Loop wired system.
- Choice of panels from 4-way through to 127-way.
- Fully networkable.
- Multiple panels can be fitted on a network system.
- Optional connection to a fire alarm panel.
- Optional connection to a remote indicator for unattended panels.
- Toilet alarm connection ability.
- Choice of finish for panels and outstations, including toilet alarm.
- Any combination of outstation can be connected on a loop.
- Button control with LED indicators.
- Lockable glazed door on control panels.

CARE2 - Radial Wired Emergency Voice Communication



Features

- Radial wired system.
- 4-way panels, easily expanded to 8, 12 or 16-way by the addition of line cards.
- System networking via expansion panels.
- Optional connection to a remote indicator for unattended panels (add module).
- Toilet alarm connection ability.
- Choice of finish for panels and outstations, including toilet alarm.
- Any combination of outstation can be connected to a single panel.
- LCD display and rotary encoder for easy control.
- Robust red handset with T-coil in control panel.
- Lockable door covering handset.

Omnicare or Care2 EVC ?

The table below highlights the main differences between the two systems.



General	OMNICARE	CARE2
System type	Loop wired	Radial wired
Cabling	4 core fire resisting	2 core fire resisting
Networking	Yes (maximum 127 outstations)	Yes (maximum 256 outstations)
Control panels	4, 8, 16, 32, 48, 64, 80, 96, 112 or 127 way	4 way (expandable to 8, 12 or 16 way)
Options		
Finish	Grey or stainless steel	Black or stainless steel
Operation	Tactile membrane switches	LCD screen & rotary encoder
Mounting	Surface or flush mount with bezel	
Lockable door	Full cover - glazed	Covers handset only
Disabled Refuge		
Standard outstation finish	Green or stainless steel	
Advance outstation finish	Green or stainless steel with Braille & raised luminescent text	N/A
Induction loop	In the front panel of Advance outstation Not available on the standard outstation	Output to feed external amplifier
Call reset	At the control panel or outstation	At the control panel
Fire Telephone		
Fire telephone finish	Red or stainless steel	
Door type	Push or slot lock	
Operation	Opening door initiates call. Lift handset for speech communication	
Conference call facility	Via control panel	Via control panel (including roaming telephones)
External beacon/sounder	Available as an option	N/A
Steward Telephone		
Finish and operation	Green finish. Operation is the same as for the fire telephone	
Roaming telephone		
Roaming handset	N/A	Red
Monitored handset enclosure	N/A	holds up to 6 handsets Black or stainless steel finish
Jack sockets	N/A	UK or American. Stainless steel finish
Disabled toilet alarm		
Connection to system	Via repeater unit	Direct to control panel

8.04

Omnicare Emergency Voice Communication

Omnicare Loop-Wired EVC



The OmniCare system was the first of its kind when introduced as a combined EVC system. Since then it has been installed worldwide and has become the system of choice for many. The system includes a three-part toilet alarm kit option which, like all of the remote units, is powered from the line.

General Information

- There are two main components - the master control panel(s) and the remote units (outstations).
- Remote units are wired in a ring circuit configuration and are 'self-learning', with an auto-commissioning feature.
- The ring circuit technology enables continued operation, even in the event of a cable break.
- Any combination of remote units can be linked to the control panel on a single wiring loop.
- The master control panel is typically wall mounted in a central control room.
- Remote units are wall mounted in locations such as refuge areas, stairwells, fallback positions, corridors and other 'gathering' points, at a height easily reached by users (as detailed in BS5839-9).
- More than one master panel can be placed on the ring circuit, thus allowing control of local areas.

System Benefits

- Loop wiring provides time and cost savings on new installations.
- Combinations of outstation can be fitted on a single loop.
- Combined outstation available featuring a disabled refuge and fire telephone in one housing.
- Full networking and multi-panel facilities.
- All outstations powered from the line, including toilet alarms.
- Standard and Advance disabled refuge outstations available.
- Backup batteries supplied with every control panel.
- Robust, reliable and well established system.
- Operates even if there is a break in the loop.

Features

- One master and multiple slave panels can be linked on one system.
- Control panel options from 4-way through to 127-way.
- Remote units are connected to the control panel in a loop configuration.
- Fully compliant to BS5839-9:2011.
- Assists companies with compliance to BS9999:2008.
- Addressable system via the remote units.
- Link to the fire detection system prevents hoax disabled refuge calls (toilet alarms, fire and steward telephones remain active). Can be completely or partly overridden.
- Speech steered (disabled refuge remotes) and full duplex speech (fire telephones and steward telephones).
- Full system monitoring.
- Battery backed for use in the event of mains power failure (24 hours in standby plus three hours use, as standard).
- Any combination of the following outstations can be installed on a single system:
 - Disabled refuge remotes (Type B outstations).
 - Firefighter telephones (Type A outstations).
 - Emergency (steward) telephones (Type A outstations).
 - Combined disabled refuge and fire telephone.
 - Disabled toilet alarms.

Omnicare Control Panels



Features

- Available in a variety of options to suit systems of 4-127 way.
- One master and multiple slave panels can be linked on one system (configured on installation).
- Output for unanswered call indicator; with adjustable delay - useful when the control panel is not always manned. (Can be used with Remote Lamp/Buzzer.)
- Volt free contact (Operated when in fault, set during installation).
- Lockable glazed door.
- Indicators for: in use/occupied, call, fault, power, charger and speech volume.
- Handset volume control and 'Listening' facility.
- Fire panel interface.
- Available in grey or stainless steel finish.

Order Codes



Order Codes		Product Code	Bezel	Rack Mount Kit	Remote Lamp / Buzzer	Spare Key
Mini - Grey Dimensions (mm): 410 W x 290 H x 200 D	4-way	131.4640 BVOC4M	131.4610 BVCRFB2	131.4790 BVCRM3	BVOC	131.4630 KEYBVE
	8-way	131.4650 BVOC8M				
	16-way	131.4660 BVOC16M				
	32-way	131.4670 BVOC32M				
Mini - Stainless Steel Dimensions (mm): 410 W x 290 H x 200 D	4-way	131.4645 BVOC4MS	131.4620 BVCRFB2S	N/A		
	8-way	131.4740 BVOC8MS				
	16-way	131.4750 BVOC16MS				
	32-way	131.4760 BVOC32MS				
Standard - Grey Dimensions (mm): 410 W x 455 H x 200 D	48-way	131.4680 BVOC48	131.4600 BVCRFB1	131.4800 BVCRM1		
	64-way	131.4690 BVOC64				
Standard - Stainless Steel Dimensions (mm): 410 W x 455 H x 200 D	48-way	131.4770 BVOC48S	131.4605 VCRFB1SS	N/A		
	64-way	131.4780 BVOC64S				
Large - Grey Dimensions (mm): 410 W x 777 H x 200 D	80-way	131.4700 BVOC80				
	96-way	131.4710 BVOC96				
	112-way	131.4720 BVOC112				
	128-way	131.4730 BVOC128				

8.06

Omnicare Disabled Refuge

Disabled Refuge (Type B)







Features

- Provides two-way communication between building management and person(s) occupying a 'Refuge Area' during an emergency evacuation - typically a fire.
- User simply presses the button to initiate call (occupy area). Further communication is hands free at the refuge point or by the user at the control panel.
- Calls are reset either at the control panel or via the remote, when the refuge area occupant has been evacuated to safety.
- The refuge outstations have a volt free contact, active when occupied, to silence loudspeakers, operate over-door lamps, etc.
- Available in either Standard or Advanced options, with either a green or stainless steel finish.
- Advanced unit additional features: Integral induction loop, tactile luminescent text, Braille and a large call button with integral high intensity LED ring.

Order Codes

	Product Code	Bezel	Plasterboard Backbox	IP66 Enclosure	Spare Key
Standard GREEN	131.3410 BVOCECPG	131.3420 BVCRMGRN	131.3960 BVCRFBG	131.3430 BVCRIPBG	131.4360 KEYBVR
Standard STAINLESS STEEL	131.4820 BVOCECPS	131.4540 BVCRMSS	131.4510 BVCRFBS		
Advance GREEN	131.4831 BVOCA2G	131.4833 BVOCA2GBZ	N/A		
Advance STAINLESS STEEL	131.4841 BVOCA2S	131.4843 BOCA2SBZ			

Disabled Refuge Signs

	Description	Order Codes
	<p>Refuge Point Dimensions: 348W x 248H mm</p>	<p>131.3440 BVOCLAB1</p>
	<p>Keep Clear, Refuge Point Dimensions: 348W x 248H mm</p>	<p>131.3460 BVOCLAB3</p>
	<p>These premises have a disabled persons evacuation point Dimensions: 348W x 248H mm</p>	<p>131.3450 BVOCLAB2</p>
	<p>Refuge Point Dimensions: 120W x 120H mm</p>	<p>131.3470 BVOCLAB4</p>

8.08

Omnicare Fire Telephone & Combined Units

Fire Telephone (Type A)



Features

- Telephone handset in a metal enclosure. Used by fire officers/building control during an emergency, such as a fire.
- Assists with the efficient evacuation of a building.
- Robust red handset with hearing aid compatible earpiece (T-coil).
- Provides clear, full duplex, two-way communication with the control panel.
- Conference facility via control panel.
- Speaker for local broadcast from the control panel.
- Calls are initiated by simply opening the door.
- Available in either a red or stainless steel finish.

Order Codes

Fire Telephones	Push Door	Push Door + Beacon	Lock Door	Lock Door + Beacon	Bezel
Fire Telephone RED	131.4805 BVOCF	131.4815 BVOCFB	N/A	131.4825 BVOCFLB	131.4560 BVFHBEZ
Fire Telephone STAINLESS STEEL	131.4835 BVOCFS	N/A	131.4845 BVOCFSL		131.4570 BVFHBEZSS



	Product Code
Repeater Unit - ZINTEC finish	131.3400 BVOCRIF

Combined Units



Features

- Disabled refuge and fire telephone in a single enclosure.
- Shows as a single presence on the control panel.
- Designed to enable correct mounting positions for each section of the unit (as set out in BS5839-9).

Order Codes

Combined Units	Push Door	Push Door + Beacon	Bezel
DRS & FT in one housing RED	131.4850 BVOC	131.4855 BVOCB	1131.4580 BVOCFBR
DRS & FT in one housing STAINLESS STEEL	131.4860 BVOCSP	N/A	131.4590 BVOCFBS



	Product Code
Repeater Unit - ZINTEC finish	131.3400 BVOCRIF

Steward Telephones



Features

- Designed for sports venues and stadia, the steward telephone has the same facilities as the fire telephone.
- The distance between outstations in sports venues should be no greater than 60 m (BS5839-9:2011 "no-one should have to travel more than 30 m to reach an outstation").
- Green finish.

Order Codes

Steward Telephone	Push Door	Push Door + Beacon	Lock Door	Lock Door + Beacon	Bezel
Steward telephone GREEN	131.3510 BVOCET	131.3520 BVOCETB	131.3540 BVOCETL	131.3550 BVOCETLB	131.3530 BVOCETBZ

Disabled Toilet Alarm



Features

- Fits to the system via a repeater unit (order separately).
- Powered via the line (no local power required).
- Fully compliant to BS8300:2009.
- Connect up to two toilet alarm kits per repeater (shown as one point on the panel).
- Caller reassurance facility.
- Each kit comprises: ceiling mounted pull switch, reset button with LED and over-door triangular light/sounder.
- Available in either a white or stainless steel finish.

Order Codes

Disabled Toilet Alarm	White	Stainless Steel
Full Kit (3 parts + Disabled WC sign)	131.3860 DTAKIT	131.3900 DTASKIT
Pull cord	131.3850 DTACP	131.3890 DTASCP
Local reset switch	131.3880 DTARP	131.3920 DTASRP
Overdoor light/sounder	131.3870 DTAODL	131.3910 DTASODL

8.10

Omnicare EVC system Schematic

Omnicare System Schematic

Remote lamp/buzzer option provides notification of an unanswered call.



Any combination of outstation can be placed on a single loop (typically 20-30 units)

Enhanced 1.5 mm 4-core fire rated cable (standard fire resisting cable may be used for some systems refer to BS5839-9)

1.0 mm 2-core screened cable

2-core security cable
Up to 2 toilet alarms can be fitted to a repeater

Systems can be networked

Up to 200 m between units (use a repeater for longer runs)

Enhanced 1.5 mm 4-core fire rated cable

More than one panel can be placed on the loop to enable control of local areas

The master panel must be large enough to see all the outstations on the systems

System Requirements

- Fire rated enhanced four core, colour coded, cable with a screen must be used for fire fighting systems.
- Standard fire resisting cables could be considered suitable for:
 - EVC systems for use in disabled refuges but not for fire fighting in (a) sprinklered buildings; (b) unsprinklered buildings less than 30m in height, provided that evacuation takes place in three or fewer phases.
- Underground sections of cabling at sports and similar venues.
- A repeater unit must be used if the distance between remotes exceeds 200m.
- Disabled refuge, advance disabled refuge, fire telephone, emergency/steward telephone, combined DRS/fire telephone and toilet alarm units can be placed on the same loop.
- Typically 20-30 remotes per loop.
- Repeater units are used to connect the toilet alarms to the system. Up to two (3-part) toilet alarm kits can be connected to a repeater unit. (Alternatively one toilet alarm kit with an additional pull cord can be installed. Useful for rooms with two points of call, e.g. a toilet cubicle or shower area.)
- No local power required for any outstation, including disabled toilet alarms.
- The capacitance of MICC cable varies between manufacturers, if the specification is for MICC cable and if the runs are greater than 100 metres, you may wish to contact our technical team to ensure it is within tolerance:
 - MICC lightweight 4-core with screen: 100m
 - MICC heavyweight 4-core with screen: 200m
 - Enhanced colour coded 4-core with screen: 200m (recommended by the manufacturer).

Omnicare Technical Information

System Specification

	Control Panel	Disabled Refuge	Fire Telephone	Emergency / Steward Telephone	Combined DRS & Fire Telephone
Power supply	230 Vac	12-40 Vdc powered from ring circuit			
Power Consumption	10 VA + 1 VA per remote fitted	30 mA @35 V typical			
Humidity range	95% non-condensing				
Temperature range	-10°C to +30°C	-10°C to +40°C			
Indicators	In use, call, fault, power, charger & speech volume	System healthy, status + (Advance) system active	System healthy		System healthy, call status
Dimensions (mm) WxHxD	Mini: 461 x 340 (25) Standard: 461 x 506 (25) Large: 461 x 827 (25)	Standard: 154 x 154 (10) Advance: 230 x 490	170 x 390 (20)		170 x 520
Bezel cut out (mm)	Mini: 420 x 300 Standard: 420 x 465 Large: 420 x 787	Standard: 136 x 136 Advance: 190 x 450	138 x 358		138 x 488
Knockouts/cable entry points	20 mm top & rear	20 mm & 25 mm			20 mm & 25 mm*
Finish	Grey or stainless steel	Std: green or stainless steel Adv: green or stainless steel with Braille & tactile luminescent text	Red or stainless steel	Green	Red or stainless steel

* 2 x 20 mm top (site wiring), and 2 x 20 mm bottom (relay contacts from disabled refuge section).

Disabled Toilet Alarm Specification

	Overdoor Light / Sounder	Reset Point	Ceiling Pull
Alarm Type	90dB @ 30cm		
Dimensions (WxHxD)	White: 85 x 85 x 58 mm Stainless steel: 85 x 85 x 60 mm	White: 85 x 85 x 13 mm Stainless steel: 85 x 85 x 14 mm	White: 30 x 80 mm (dia) Stainless steel: 85 x 85 x 14 mm
Cable Requirements	2-core Security Cable		
Backbox Requirements (Not Supplied)	25mm deep single gang flush back box or 'round cornered' plastic surface box		White: supplied in a surface mount enclosure Stainless steel: 25 mm deep single gang flush back box or 'round cornered' surface box

Please Note: Stainless steel products are not intended for installation in humid areas.

BS8300:2009 requires that all new disabled toilets are fitted with an emergency toilet alarm.

8.12

CARE2 Emergency Voice Communication

CARE2 Emergency Voice Communication



CARE2 is a radial wired emergency voice communication system built to the high standard you expect from Baldwin Boxall. It is stylish, versatile and easy to use and offers an alternative to the well-established loop-wired Omnicare range.

System Benefits

- Stylish, versatile and simple to navigate and control.
- Suitable for small or large systems - fully networkable.
- Monitored roaming telephone handsets - enables use with confidence.
- System configuration via SD card, front panel or PC connection.
- Facilitates clear communication during an emergency event.
- Ideal for retro-fitting old star-wired systems.
- Quality built, robust system.
- Activity/fault log.
- Outstations, including toilet alarms, powered directly from the line - no local power needed..
- Any combination of outstation on one system.

System Benefits

- There are three main components - control panel, network expansion panels (NEP) and the remote units.
- Remote units are wired in a radial (star-wired) configuration. Control/NEP panels are loop wired.
- Two control panels can be installed on a networked system (the second one will serve as a 'slave' unit unless activated as the 'master' during an emergency).
- Any combination of remote units can be connected to a control/NEP panel.
- Any number of jack sockets (for the roaming telephone) can be daisy chained (up to 500m; EOL resistor required in end unit). One handset will be operational per line at any one time.
- Outstations and control/NEP panels can be surface mounted or flush mounted with optional bezel. Back boxes are required for the roaming telephone jack sockets, toilet alarm reset and overdoor light.

Features

- CARE2 is an all-in-one Emergency Voice Communication (EVC) system.
- Fully monitored and battery-backed (24 hours quiescent and three hours functional).
- Fully compliant to BS5839-9:2011. Assists companies with compliance to BS9999:2008.
- Remote units are wired in a radial (star) configuration using two core (fire resisting enhanced/non-enhanced) cable.
- Fully networkable. Networked panels are wired in a loop configuration using 2 x two core (fire resisting enhanced) cable.
- In the event of a break in the network loop, the system will continue to function.
- All outstations are powered from the line, including the roaming telephone enclosure and disabled toilet alarms.
- Optional link to fire detection system prevents hoax disabled refuge calls (C2CFPE required). Firefighter, roaming telephones and toilet alarms remain active.
- Speech steered; disabled refuge outstations.
- Full duplex speech; firefighter and emergency/steward telephones.
- Any combination of the following outstations can be installed on a single system:
 - Disabled refuge (Type B outstations).
 - Firefighter telephones (Type A outstations).
 - Steward (emergency) telephones (Type A outstations).
 - Roaming telephones.
 - Disabled toilet alarms.
- The control console is typically wall mounted in a central control room.
- Remote units are wall mounted in locations such as refuge areas, stairwells, fallback positions, corridors and other 'gathering' points, at a height easily reached by users.
- All outstations are powered from the line, including the disabled toilet alarms and roaming telephone handset enclosure.
- System configuration is stored on an SD card and can be modified either with a PC (via Ethernet or directly onto the SD card) or without (via the encoder and display).
- Up to two disabled toilet alarms can be connected to one line (Or one toilet alarm with two ceiling pulls).

CARE2 Control / Slave Panels



Each control panel is supplied as 4-way unit as standard. Add C2CEK4 line cards to increase to 8, 12 or 16-way.

Features

- Unique design and easy to operate using the rotary encoder and clear LCD screen.
- The rugged red handset (with hearing aid compatible earpiece) is mounted in a lockable compartment.
- System configuration is stored on an SD card and can be modified either with a PC (via Ethernet or directly onto the SD card) or without (via the encoder and display).
- Includes a fault relay for indicator at the fire panel.
- The system can be connected to a local fire panel using the interface module.
- Two of these panels can be installed on a networked system (network cards required). One panel will act as a 'slave' unit. The 'slave' unit can be activated as the 'master' if required (typically during an emergency).

Order Codes

	Black	Stainless Steel	4-Way Exp. Card	Fire Panel Interface	Network Card	Rack Mount Kit	Spare Key
Control Console - 4 way	131.3560 C2CB4	131.3630 C2CS4	131.3590 C2CEK4	131.3600 C2CFPE	131.3610 C2CN	131.3620 C2CRM	131.4630 KEYBVE
Bezel	131.3580 C2CBZ	131.3650 C2CSZ	N/A				

CARE2 Network Expansion Panel (NEP)



Each NEP is supplied as 4-way unit as standard. Add C2CEK4 line cards to increase to 8, 12 or 16-way.

Features

- Facilitates expansion of the CARE2 system.
- Fit up to 15 NEPs on a network (or fourteen if installing two 'control' panels), enabling systems of 256 outstations. (If you have a requirement for a larger system, please contact our sales department to discuss.)
- The NEP is supplied as a 4-way unit as standard. Simply increase to 8, 12 or 16-way by fitting line cards. (Each NEP is fitted with a network card).
- For initial system set-up and local testing (prior to connection to the network) a 'roaming telephone' can be temporarily connected to an internal socket.
- The status of local outstations can be viewed by using the rotary encoder and LCD screen.

Order Codes

	Black	Stainless Steel	4-Way Exp. Card	Fire Panel Interface	Network Card	Rack Mount Kit	Spare Key
NEP - 4 way	131.3570 C2CBNEP	131.3640 C2CSNEP	131.3590 C2CEK4	131.3600 C2CFPE	131.3610 C2CN	131.3620 C2CRM	131.4630 KEYBVE
Bezel	131.3580 C2CBZ	131.3650 C2CSZ	N/A				

Note: For both the CARE2 Control Panel and the NEP, integral batteries (supplied) enable continuation of system use during mains power failure (24 hours in standby and three hours operational).

8.14

CARE2 Expansion Cards & Modules



CARE2 Remote Lamp / Buzzer



Features

- Provides a visible and audible signal of a call on the CARE2 system (The control panel sounder must be enabled, not silenced).
- Uses the output on either a network or fire panel interface card.
- Has an adjustable delay of 3-200 seconds.

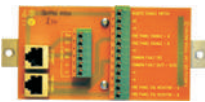
CARE2 Panel Expansion Cards & Modules

	Description	Order Codes
	4-way Line Card <ul style="list-style-type: none">• Each module enables the addition of four outstations.• Add these modules to the control panel(s) and/or NEPs as required.• Up to three modules can be added per panel/NEP	131.3590 C2CEK4
	Fire Panel Interface Card <ul style="list-style-type: none">• Includes Ethernet connection ability.• Optional module which fits in the control panel (not required if a network card has been fitted).• Use to keep disabled refuge outstations in 'standby' mode until activated by the fire panel.• Add for connection to remote lamp/buzzer	131.3600 C2CFPE
	Network Card <ul style="list-style-type: none">• Includes fire panel interface & Ethernet connection ability.• Add one to each control panel for including on a networked system.	131.3610 C2CN

Disabled Refuge (Type B)



Features

- Provides two-way communication between building management and person(s) occupying a 'Refuge Area' during an emergency evacuation - typically a fire.
- User simply presses the button to initiate call (occupy area). Further communication is hands free at the refuge point or by the user at the control panel.
- Calls are reset at the control panel when the refuge area occupant has been evacuated to safety.
- The unit has an output to feed an external induction loop amplifier.
- Disabled refuge outstations on the system are permanently 'active'. As an option (by fitting a fire panel interface or network card to the control panel) they can be set to 'standby' mode until activated by the fire panel.
- Available in green or stainless steel finish

Order Codes

Disabled Refuge	Product Code	Bezel	Plasterboard BackBox	IP66 Enclosure
Standard GREEN	131.3760 C2RRG	131.3420 BVCRMGRN	131.3930 C2RRGPB	131.3950 C2RRBIP
Standard STAINLESS STEEL	131.3770 C2RRS	131.4540 BVCRMSS	131.3940 C2RRSPB	

Disabled Refuge Signs

	Description	Order Codes
	Refuge Point Dimensions: 348W x 248H mm	131.3440 BVOCLAB1
	Keep Clear, Refuge Point Dimensions: 348W x 248H mm	131.3460 BVOCLAB3
	These premises have a disabled persons evacuation point Dimensions: 348W x 248H mm	131.3450 BVOCLAB2
	Refuge Point Dimensions: 120W x 120H mm	131.3470 BVOCLAB4

8.16

CARE2 Fire & Steward Telephones

Fire Telephone (Type A)



Features

- Telephone handset in a metal enclosure. Used by fire officers/building control during an emergency, such as a fire.
- Assists with the efficient evacuation of a building.
- Robust red handset with hearing aid compatible earpiece (T-coil).
- Provides clear, full duplex, two-way communication with the control panel.
- Push door or slot lock versions available.
- Conference facility for fire and roaming telephones via control panel (recommended maximum of five including the control panel).
- Calls are initiated by simply opening the door.
- Available in red or stainless steel finish.

Order Codes

Fire Telephones	Push Door	Lock Door	Bezel
Fire Telephone RED	131.3710 C2FTRP	131.3700 C2FTRL	131.3720 C2FTRZ
Fire Telephone STAINLESS STEEL	131.3670 C2ETGP	131.3660 C2ETGL	131.3680 C2ETGZ

Note: Control panels & outstations are supplied as surface mounting units. To flush mount simply add the appropriate bezel. (This does not apply to toilet alarms & jack sockets.)

Steward Telephone



Features

- Designed for sports venues and stadia, the steward telephone has the same facilities as the fire telephone.
- The distance between outstations in sports venues should be no greater than 60 m (BS5839-9:2011 "no-one should have to travel more than 30 m to reach an outstation").
- Green finish.

Order Codes

Steward Telephone	Push Door	Lock Door	Bezel
Steward Telephone GREEN	131.3740 C2FTSP	131.3730 C2FTSL	131.3750 C2FTSZ

Roaming Telephone

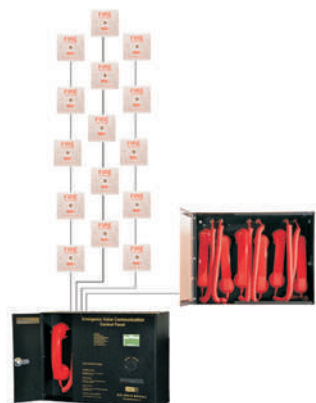

Features

- Robust red handset with hearing aid compatible earpiece.
- Any number of jack sockets can be daisy chained (Up to 500m. EOL resistor required in end unit). (One handset operational per line at any one time).
- The enclosure features a lockable glass door and stores up to six handsets (order separately).
- Handsets in the enclosure are monitored at all times (green reassurance LEDs).
- Jack sockets are flush mounting (back box required).
- UK & American options available.

Order Codes

Roaming Telephone	Product Code	Bezel
Monitored Enclosure BLACK	131.3780 C2RTEB	131.3580 C2CBZ
Monitored Enclosure STAINLESS STEEL	131.3790 C2RTES	131.3650 C2CSZ
Telephone Handset	131.3800 C2RTH	N/A
Jack Socket UK	131.3820 C2RTJUK	N/A
Jack Socket American	131.3810 C2RTJA	N/A

Note: Control panels & outstations are supplied as surface mounting units. To flush mount simply add the appropriate bezel. (This does not apply to toilet alarms & jack sockets.)

8.18

CARE2 Disabled Toilet Alarm

Disabled Toilet Alarm



Features

- The 3-part toilet alarm connects directly to the CARE2 control panel or NEP.
- Powered from the line (does not require local power).
- Fully compliant to BS8300:2009.
- Up to two toilet alarm kits can be connected to one line (will show as one point on the panel).
- Caller reassurance facility.
- Each kit comprises: ceiling mounted pull switch, reset button with LED and over-door triangular light/sounder.
- Available in either a white or stainless steel finish.

Order Codes

Disabled Toilet Alarm	White	Stainless Steel
Full Kit (3 parts + Disabled WC sign)	131.3860 DTAKIT	131.3900 DTASKIT
Pull cord	131.3850 DTACP	131.3890 DTASCP
Local reset switch	131.3880 DTARP	131.3920 DTASRP
Overdoor light/sounder	131.3870 DTAODL	131.3910 DTASODL

CARE2 System Schematic

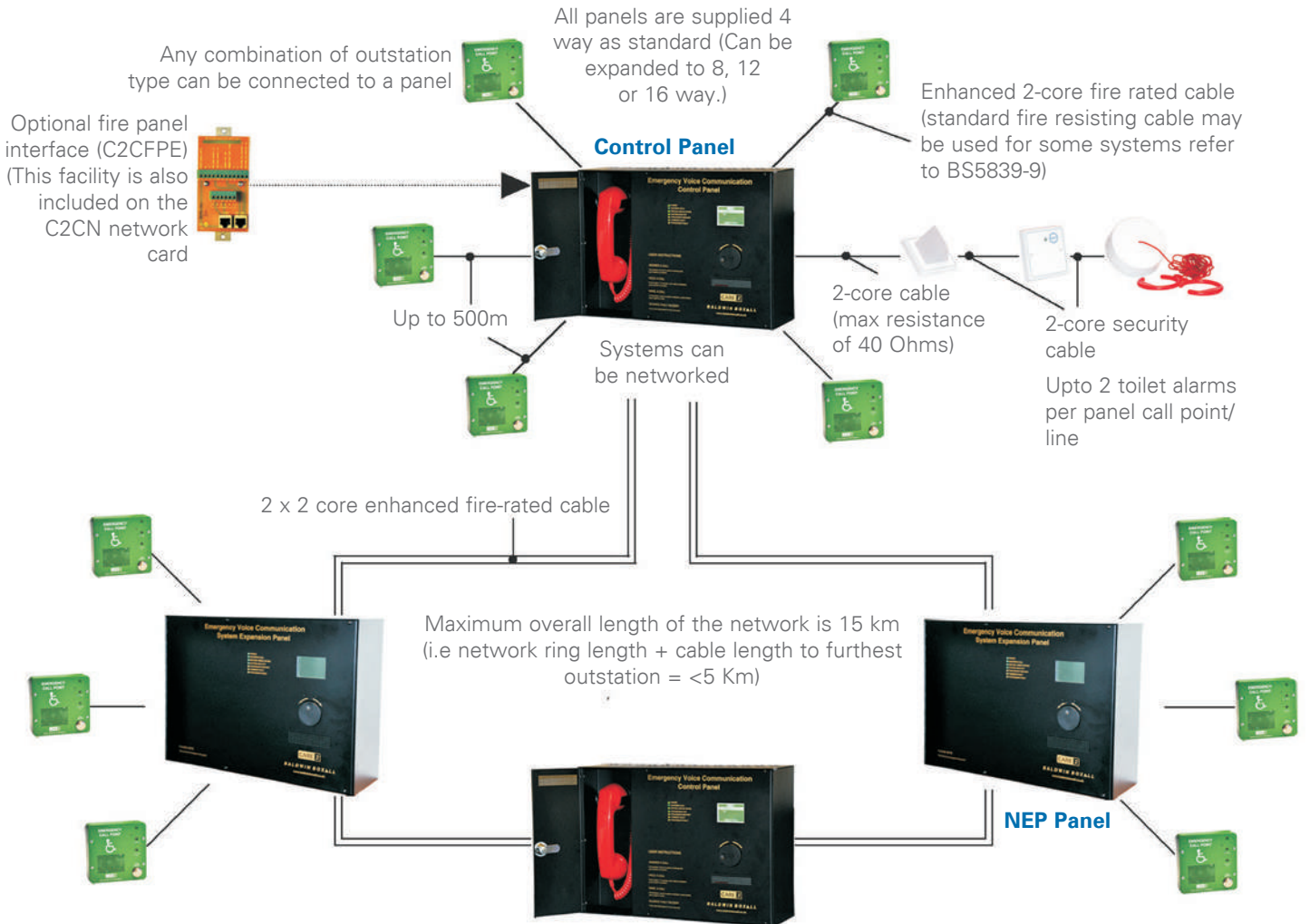

Up to 16 panels can be placed on the network (2 of these can be control panels, one of which will act as a slave unless activated as the master during an emergency).



8.20

CARE2 Technical Information

CARE2 Technical Information

System Specification

	Control Panel & NEP	Disabled Refuge	Fire Telephone	Steward Telephone	Roaming Telephone Jack Socket	Roaming Telephone Enclosure
Power supply	230 Vac 50-60Hz	20-30Vdc self-powered from line				
Power Consumption	75VA Max	N/A				
Humidity range	95% non-condensing					
Temperature range	-10°C to +40°C					
Indicators Include	4 x green LEDs: Power, call, RR active, healthy. 3 x yellow LEDs: Processor restart, common fault, processor fault.	1 x red LED: 'status' 1 x green LED: 'system ok'	1 x red LED: status indicator	1 x green LED: status indicator	N/A	1 x green LED: status indicator
Dimensions (mm) WxHxD	430 x 310 x 130	134 x 134 x 44	130 x 330 x 75	130 x 330 x 75	85 x 85	430 x 310 x 130
Bezel Dimensions (mm)	470 x 350	154 x 154	170 x 370	170 x 370	N/A	N/A
Bezel cut out (mm)	440 x 320	136 x 136	136 x 336	136 x 336	N/A	N/A
Backbox Requirements WxHxD	N/A	N/A	N/A	N/A	85 x 85 x 35	N/A
Knockouts/cable entry points (mm)	Top: 23 x 20	Top: 4 x 20 Bottom: 4 x 25	Top: 1 x 20	Top: 1 x 20	N/A	Top: 23 x 20
Finish	Black or stainless steel	Green or stainless steel	Red or stainless steel	Green	Stainless steel	Black or stainless steel

Disabled Toilet Alarm Specification

	Overdoor Light / Sounder	Reset Point	Ceiling Pull
Alarm Type	90dB @ 30 cm		
Dimensions (WxHxD)	White: 85 x 85 x 58 mm Stainless steel: 85 x 85 x 60 mm	White: 85 x 85 x 13 mm Stainless steel: 85 x 85 x 14 mm	White: 30 x 80mm (dia) Stainless steel: 85 x 85 x 14 mm
Cable Requirements	2-core Security Cable		
Backbox Requirements (Not Supplied)	25 mm deep single gang flush back box or 'round cornered' plastic surface box		White: supplied in a surface mount enclosure Stainless steel: 25 mm deep single gang flush back box or 'round cornered' surface box

Please Note: Stainless steel products are not intended for installation in humid areas.

BS8300:2009 requires that all new disabled toilets are fitted with an emergency toilet alarm.



System Accessories

Batteries

Power Supplies

Door Release Equipment

Auxiliary Interface Relays

Frames & Document Boxes

Fire Resistant Cable

9.02

Batteries

Batteries



Product Codes	Voltage (V)	Ah at 20h rate	Length (mm)	Width (mm)	Height (mm)	Height including Terminals
PS-1221	12	2.1	178	35	60	66
PS-1230	12	3.0	134	67	60	66
PS-1270	12	7.0	151	65	94	98
PS-1212	12	12	97	42	51	54
PS-12650	12	65.0	348	167	178	178
PS-12380	12	38.0	197	165	170	170
PS-6100	6	10.0	151	51	94	98
PS-12170	12	17.0	181	76	167	167
PS-12260	12	26.0	166	176	112	125
PS-1242	12	4.5	90	70	101	105
PS-12120	12	12.0	151	98	94	100

Order Codes

PS-1221	12 Volt 2.1 Ampere hour rechargeable sealed lead acid battery
PS-1230	12 Volt 3.0 Ampere hour rechargeable sealed lead acid battery
PS-1270	12 Volt 7.0 Ampere hour rechargeable sealed lead acid battery
PS-1212	12 Volt 12 Ampere hour rechargeable sealed lead acid battery
PS-12650	12 Volt 65.0 Ampere hour rechargeable sealed lead acid battery
PS-12380	12 Volt 38.0 Ampere hour rechargeable sealed lead acid battery
PS-6100	6 Volt 10.0 Ampere hour rechargeable sealed lead acid battery
PS-12170	12 Volt 17.0 Ampere hour rechargeable sealed lead acid battery
PS-12260	12 Volt 26.0 Ampere hour rechargeable sealed lead acid battery
PS-1242	12 Volt 4.5 Ampere hour rechargeable sealed lead acid battery
PS-12120	12 Volt 12.0 Ampere hour rechargeable sealed lead acid battery

24 V 5 A Power Supply Unit



This PSU is approved by IMQ to EN 54-4:1997 + A1:2002 and EN60950-1:2001. The steel housing contains a 5 amp switch mode power supply and monitoring board and has space to accommodate 2 x 12 V 17Ah sealed lead acid batteries. The 10 front panel LED's comprehensively indicate the status of the unit.

Features

- Robust metal housing
- Twin fused outputs
- Temperature compensated charging
- Deep discharge protection of batteries
- Fault relay output
- Comprehensive LED status indication

Technical Information

Dimensions: 408H x 383W x 97D mm
 Weight: 4.3 Kg (excluding batteries)
 Operating Temp: -5°C to +40°C
 Supply voltage: 230Vac 50/60Hz

Order Code

558.004.020 24 V 5 A Power Supply Unit with housing for 17A/H Batteries

24 V 5 A Power Supply Unit

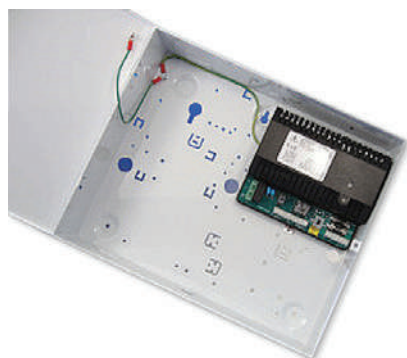

The new STX range of switch mode power supplies has been specifically designed for EN54 compliant fire systems.

Available in 2 A versions they are certified to EN54-4:1997, A1:2002 & A2:2006. The units include intelligent battery charging using Elmdene's efficient EcoCharge technology, possess mains & battery monitoring with independent voltfree outputs and also feature battery deep discharge protection in the event of a prolonged mains failure.

The inclusion of LED indicators provides quick diagnostics of the status of the power supply, while a variety of enclosures offer the installer a choice of standby battery backup options.

Order Codes

- 558.004.021 Compact Power Supply
 EN54 2A 7AH 24 Vdc (27.6V)
 2A to load +0.3A battery charging
 Fit up to 2 x 7Ah batteries
 275H x 330W x 80D - Hinged lid
- 558.004.022 Compact Power Supply
 EN54 2 A 17Ah 24 Vdc PSU (27.6 V)
 2A to load + 0.3A battery charging
 Fit up to 2 x 7Ah batteries
 420h x 400w x 80 x 80D - Hinged lid

9.04

Door Release Equipment





Door Release Magnets



Features

- Integral release button
- Attractive design
- Slimline ABS housed units
- Robust floor mounted unit

The door magnet range encompasses 2 metal and 2 ABS housed wall mounted and 1 floor mounted release magnet sets

	Description	Order Codes
	Door release magnet set, Wall Mount, Metal Housing, 24 Vdc 89x89x70 mm, 0.5 Kg, 180N Holding Force, 1.15W Coil @ 24 Vdc Door release magnet set, Wall Mount, Metal Housing, 230 Vac 89x89x70 mm, 0.5 Kg, 180N Holding Force, 1.15W Coil @ 230 Vac	3-59-0404-S001 3-59-0404-S002
	Door release magnet set, Wall Mount, ABS Housing, 24 Vdc 95x87x46 mm, 0.36 Kg, 200N Holding Force, 1.15 W Coil @ 24 Vdc Door release magnet set, Wall Mount, ABS Housing, 230 Vac 95x87x46 mm, 0.36 Kg, 200N Holding Force, 1.15 W Coil @ 230 Vac	3-87-0351 3-87-0352
	Door release magnet set, floor mount, ABS housing 24 Vdc 110x96x96 mm, 0.7 Kg, 200N Holding Force, 45 mA Coil @ 24 Vdc	3-84-0301
	Floor mounting bracket for adapting wall mounted door magnets to floor mount	2-34-035G-S001

Door Release Power Supply



The Transformer Rectifier is a dual purpose, smoothed power supply providing either an energised or de-energised output upon activation. The output may be activated by utilising a set of volt free contacts from a fire or security panel, or by providing a 12/24 Vdc trigger voltage from other apparatus.

The transformer rectifier units are normally used to control the operation of other 24 Vdc equipment such as magnetic door retainers. The units are ideal for applications where the supply is to be energised from a remote source.

Technical Information

Input Voltage	230 Vac 50Hz
Output Voltage	22 - 30 Vdc
Output Current	4 A Continuous
Temperature	-10C to + 40C
Relative Humidity	95% RH
IP Rating	IP41 (excluding rear face)
Material	1.2 mm white powder coated steel
Dimensions	200H x 230W x 80D mm

Order Code

[558.004.010](#) ELM 24 V 4 A Door Holder PSU

Door Release Button





Order Code

519.001.008 Door Release Button

Door Release Button (white) supplied with surface mount backbox (black) for manual release of door magnets or door release units.

Boxed Relays

	Description	Order Codes
	Metal boxed heavy duty alarm relay with 25 A mains rated DPCO contacts. Available with either a 240 VAC 12 mA rated coil. Suitable for heavy duty switching applications.	567.007.008 (240Vac)
	RU1-24 This is a metal boxed auxiliary relay with 5A Mains rated double pole contacts with a 24Vdc 25 mA coil. This compact relay is suitable for interfacing a fire alarm controller to low current mains powered devices or contactors.	RU1-24

Relay Output Board

	Description	Order Code
	A1466 Relay Output Board Gold clad contacts 2A @ 24Vdc <ul style="list-style-type: none"> • DPCO • Coil resistance 2900 ohms • Operating current 8 mA @ 24 Vdc • Operating Voltage 17.5 - 30 Vdc • Terminals suitable for 2.5 mm² cable • 26 x 60 x 18 mm • Polarised and suppressed 	508.023.036

9.06

Fire Notice Frames & Document Boxes

Fire Notice Frames

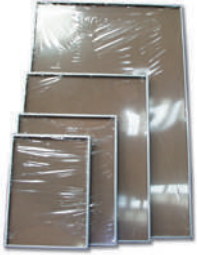

These snap fit frames are used mainly for fire alarm zone charts and are available to fit A4 to A1 size drawings.

Order Codes

A4FRAME	Fire Notice Snap Frame A4 346 x 260 x 25 mm
A3FRAME	Fire Notice Snap Frame A3 475 x 350 x 25 mm
A2FRAME	Fire Notice Snap Frame A2 650 x 475 x 25 mm
A1FRAME	Fire Notice Snap Frame A1 890 x 645 x 25 mm

A4 Document Box



Order Code

557.202.629	Fire Document Box Zettler
-------------	---------------------------

An A4 sized box ideal for the safe keeping of important fire system documents and log books. Formed from red powder coated steel with a cam lock. The box is branded Zettler with a white FIRE logo. 2 Keys are provided and all units are keyed alike.

Dimensions = 300H x 235W x 50D mm.

Fire Resistant Cable

DÄTWYLER Lifeline cable is suitable for fire alarms and emergency lighting where BS6387 and BS7629 standards are acceptable and meets the installation and performance requirements of:

- BS5839 Pt.1 for use in fire alarms
- BS5266 for use with emergency lighting
- IEC331 fire resistance

Lifeline is LPCB approved to BS6387 CAT CWZ and BASEC approved to BS7629.

Lifeline is low smoke, zero halogen, has an integral aluminium backed mylar tape screen with tinned drain wire and requires no special terminations, tools or ferrules for installation.

Technical Information

Construction

Conductor	Bare copper, solid or stranded to BS6360
Insulation	Special double layer insulation according to BS7655, E15
Inner Covering	High temperature resistant glass fibre tape
Screening	Al-Laminated tape with tinned copper drain wire, solid to BS6360
Outer Sheath	Flame retardant polyolefin compound according to BS 7655, LTS3

Technical Properties

Rated Voltage	300/500 V
Test Voltage	2000 V, 50Hz core/core 2000 V, 50Hz core/screen
Operating Temp	-15°C to +90°C
Core Colours	2 cores + earth: red, black 4 cores + earth: red,yellow,blue,black
Sheath Colour	Red or white
General Properties	Zero Halogen, no corrosive gases - IEC 60754-2, BS6425 part 1 Reduced fire propagation - IEC 60332 - 3, BS 4066 part 3 Minimum smoke emission - IEC 61034, BS7622 Insulation integrity - IEC 60331 (FE180), BS6387 (cat. CWZ)
Approvals	BASEC

Full details of Lifeline cable can be found in the DÄTWYLER Lifeline datasheets on the ZETTLER website (www.ZettlerFire.com).

DÄTWYLER offer a wide range of cable and safety cabling systems including complete safety cable systems to DIN4102 part 12.

The following DÄTWYLER Lifeline cables are held in stock at Tyco Fire Protection Products Letchworth warehouse, together with suitable P clips and glands. Cables are priced per metre but must be ordered in units of 100 metre. P clips and glands are priced each but must be ordered in packs.

Order Codes

DÄTWYLER Lifeline Cable				
Product Code	No. Cores	Core Size	Colour	Clips
599.048.020	2 + earth	1 mm	Red	P34 R
599.048.022	2 + earth	1.5 mm	Red	P34 R
599.048.023	2 + earth	1.5 mm	White	P34 W
599.048.024	2 + earth	2.5 mm	Red	P37 R
599.048.032	4 + earth	1 mm	Red	P37 R
599.048.034	4 + earth	1.5 mm	Red	P40 R
599.048.035	4 + earth	1.5 mm	White	P40 W
599.048.036	4 + earth	2.5 mm	Red	P43 R

DÄTWYLER Lifeline Fire Resistant P Clips & Glands			
Product Code	No. Cores	Core Size	Colour
599.048.000	50	P32	Red
599.048.001	50	P34	Red
599.048.002	50	P34	White
599.048.003	50	P37	Red
599.048.005	50	P40	Red
599.048.009	10	NG1	Red
599.048.010	10	NG1	White

9.8

Fire Resistant Cable

No. of Cores x Cross Section (n x mm ²)	Copper Content (Kg/Km)	Total Weight (Kg/Km)	Outer Diameter (approx. mm)	Calorific Potential (KWh/m)
2 x 1.0	19	75	7.4	0.16
2 x 1.5	29	97	8.2	0.18
2 x 2.5	48	141	9.6	0.24
4 x 1.0	39	114	8.6	0.23
4 x 2.5	96	223	11.3	0.37



Global Strength. Local expertise. *At your service.*

ZETTLER, is a leading brand of fire detection products in the European market. The ZETTLER fire detection product line includes a wide range of EN54 CPD approved fire detection products carrying approvals and cross-listings, including VdS and NF. The ZETTLER product lines are available through ZETTLER Authorised Distributors as well as many Johnson Controls offices around the world.

Tyco Fire & Security GmbH, Victor von Bruns Strasse 21, CH-8212 Neuhausen am Rheinfall, Switzerland

© 2020 Johnson Controls. All rights reserved. All specifications and other information shown were current as of document revision date and are subject to change without notice

PMC001 Issue 12.8 03/20

www.zettlerfire.com