






1X-X3E Series Installation Manual

Copyright	© 2014 UTC Fire & Security. All rights reserved.
Trademarks and patents	1X-X3E Series is a trademark of UTC Fire & Security. Other trade names used in this document may be trademarks or registered trademarks of the manufacturers or vendors of the respective products.
Manufacturer	UTC CCS Manufacturing Polska Sp. Z o.o. Ul. Kolejowa 24. 39-100 Ropczyce, Poland Authorized EU manufacturing representative: UTC Fire & Security B.V. Kelvinstraat 7, 6003 DH Weert, Netherlands
Version	This document covers control panels with firmware version 2.0 or later.
Certification	
European Union directives	1999/5/EC (R&TTE directive): Hereby, UTC Fire & Security declares that this device is in compliance with the essential requirements and other relevant provisions of Directive 1999/5/EC.
	2002/96/EC (WEEE directive): Products marked with this symbol cannot be disposed of as unsorted municipal waste in the European Union. For proper recycling, return this product to your local supplier upon the purchase of equivalent new equipment, or dispose of it at designated collection points. For more information see: www.recyclethis.info .
	2006/66/EC (battery directive): This product contains a battery that cannot be disposed of as unsorted municipal waste in the European Union. See the product documentation for specific battery information. The battery is marked with this symbol, which may include lettering to indicate cadmium (Cd), lead (Pb), or mercury (Hg). For proper recycling, return the battery to your supplier or to a designated collection point. For more information see: www.recyclethis.info .
Contact information	For contact information, see www.utcssecurityproducts.eu .

Content

	Important information	ii
Chapter 1	Introduction	1
	Product description	2
	Product compatibility	2
	Operating modes	2
Chapter 2	Installation	3
	Control panel cabinet layout	4
	Cabinet installation	5
	Connections	7
Chapter 3	Configuration and commissioning	23
	The user interface	25
	User levels	26
	Configuration overview	27
	Basic configuration	31
	Advanced configuration	37
	Expansion board configuration	60
	Fire network and repeaters configuration	62
	Commissioning	70
Chapter 4	Maintenance	75
	System maintenance	76
	Battery maintenance	77
Chapter 5	Technical specifications	79
	Zone specifications	80
	Input and output specifications	81
	Power supply specifications	83
	Mechanical and environmental specifications	84
Appendix A	Configuration presets	87
	Input and output configuration	88
	Default delays	88
	Basic configuration modes	89
	Expansion board functions	91
Appendix B	Regulatory information	99
	European standards	100
	Declared performance	101
	Electrical safety	101
	Index	103

Important information

This is the installation manual for the 1X-X3E Series Extinguishing and Fire Alarm Control Panels. Read these instructions and all related documentation entirely before operating this product.

Firmware compatibility

Information in this document covers control panels with firmware version 2.0 or later. This document must not be used as a guide to installation, configuration, or operation of control panels with an earlier firmware version.

For instructions on how to check the firmware version of your control panel, see “Configuration, software, and PCB identification” on page 59.

Advisory messages

Advisory messages alert you to conditions or practices that can cause unwanted results. The advisory messages used in this document are shown and described below.

WARNING: Warning messages advise you of hazards that could result in injury or loss of life. They tell you which actions to take or to avoid in order to prevent the injury or loss of life.

Caution: Caution messages advise you of possible equipment damage. They tell you which actions to take or to avoid in order to prevent the damage.

Note: Note messages advise you of the possible loss of time or effort. They describe how to avoid the loss. Notes are also used to point out important information that you should read.

Limitation of liability

To the maximum extent permitted by applicable law, in no event will UTCFS be liable for any lost profits or business opportunities, loss of use, business interruption, loss of data, or any other indirect, special, incidental, or consequential damages under any theory of liability, whether based in contract, tort, negligence, product liability, or otherwise. Because some jurisdictions do not allow the exclusion or limitation of liability for consequential or incidental damages the preceding limitation may not apply to you. In any event the total liability of UTCFS shall not exceed the purchase price of the product. The foregoing limitation will apply to the maximum extent permitted by applicable law, regardless of whether UTCFS has been advised of the possibility of such damages and regardless of whether any remedy fails of its essential purpose.

Installation in accordance with this manual, applicable codes, and the instructions of the authority having jurisdiction is mandatory.

While every precaution has been taken during the preparation of this manual to ensure the accuracy of its contents, UTCFS assumes no responsibility for errors or omissions.

Chapter 1

Introduction

Summary

This chapter provides an introduction to your control panel and the available operating modes

Content

Product description 2
Product compatibility 2
Operating modes 2

Product description

The 1X-X3E Series control panel provides three fire detection zones (Z1, Z2, and Z3) and several manual call point (MCP) and control inputs that control the extinguishing actions for a single extinguishing area.

If a fire detection zone is not configured as part of the extinguishing detection area, the control panel provides standard fire panel functionality for that fire detection zone (for example, the panel activates fire sounders, fire routing, and other auxiliary outputs).

Product compatibility

Products compatible with this control panel are listed in the supplied compatibility list. Compatibility with products that are not listed in that document cannot be guaranteed. For further details contact your local supplier.

Operating modes

Supported operating modes are shown in the table below. The default operating mode is EN 54-2 (with EN 54-13 supervision disabled).

Table 1: Operating modes

Operating mode	EN 54-13 option [1]	Region
EN 54-2 (default)	Yes [2]	European Union
BS 7273	No	United Kingdom
Repeater with fire routing (EN 54-2)	No	European Union
Repeater with fire routing (BS 7273)	No	United Kingdom

[1] EN 54-13 supervision requires compatible system wiring and devices and must be enabled by the installer in the control panel configuration.

[2] EN 54-13 supervision is available in zones and expansion board outputs.

Chapter 2

Installation

Summary

This chapter explains how to install your control panel, how to connect zones, fire and extinguishing system devices, and the power supply.

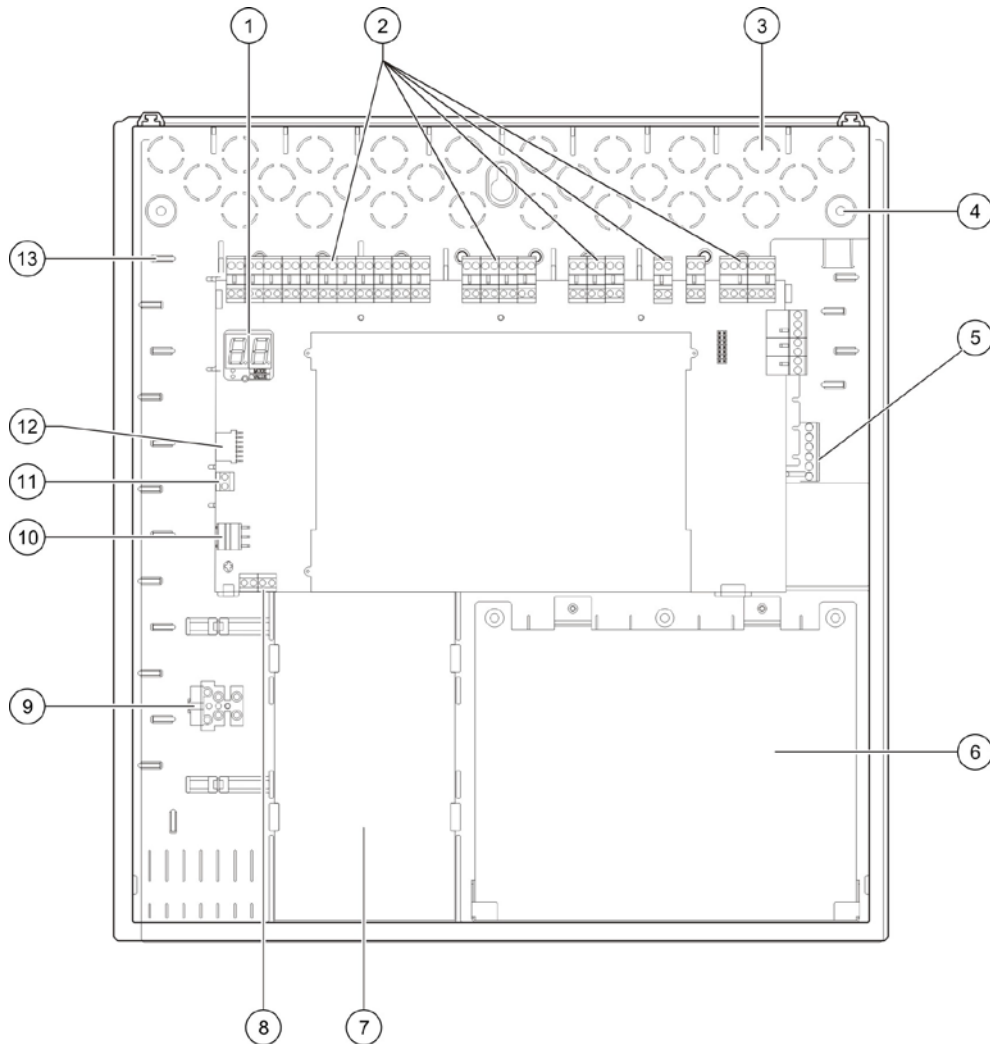
Note: This product must be installed and maintained by qualified personnel adhering to the CEN/TS 54-14 standard (or the corresponding national standard) and any other applicable regulations.

Content

Control panel cabinet layout	4
Cabinet installation	5
Preparing the cabinet	5
Where to install the cabinet	5
Fixing the cabinet to the wall	5
Connections	7
Recommended cables	7
Connecting zones with initiating devices	7
Connecting inputs	10
Connecting outputs	14
Connecting the mains power supply	17
Connecting the batteries	18
Connecting other equipment	19
Connecting expansion boards	20
Connecting a fire network	20

Control panel cabinet layout

Figure 1: Control panel cabinet layout



- | | |
|---|-------------------------------|
| 1. Seven-segment display | 7. Power supply unit |
| 2. Zone, input, output, and relay connectors | 8. Key connector (see note) |
| 3. Cable knockouts | 9. Fuse terminal block |
| 4. Mounting screw knockouts | 10. Power supply connector |
| 5. Network board connector (on the back of the PCB) | 11. Battery connector |
| 6. Battery area | 12. Expansion board connector |
| | 13. Cable holder |

Note: The control panel is available with a key option. The key switch is located on the panel cover. With this option, either the key or the password can be used to enter the operator user level. This key can also be configured to be used in manual-only or manual-automatic mode.

Cabinet installation

Preparing the cabinet

Before installing the cabinet, remove the front cover, and then remove cable knockouts from the top, bottom, and rear of the cabinet as required.

Where to install the cabinet

Make sure the installation location is free from construction dust and debris, and immune to extreme temperature ranges and humidity. (See “Mechanical and environmental specifications” on page 84 for more information on the operating temperature and relative humidity specifications.)

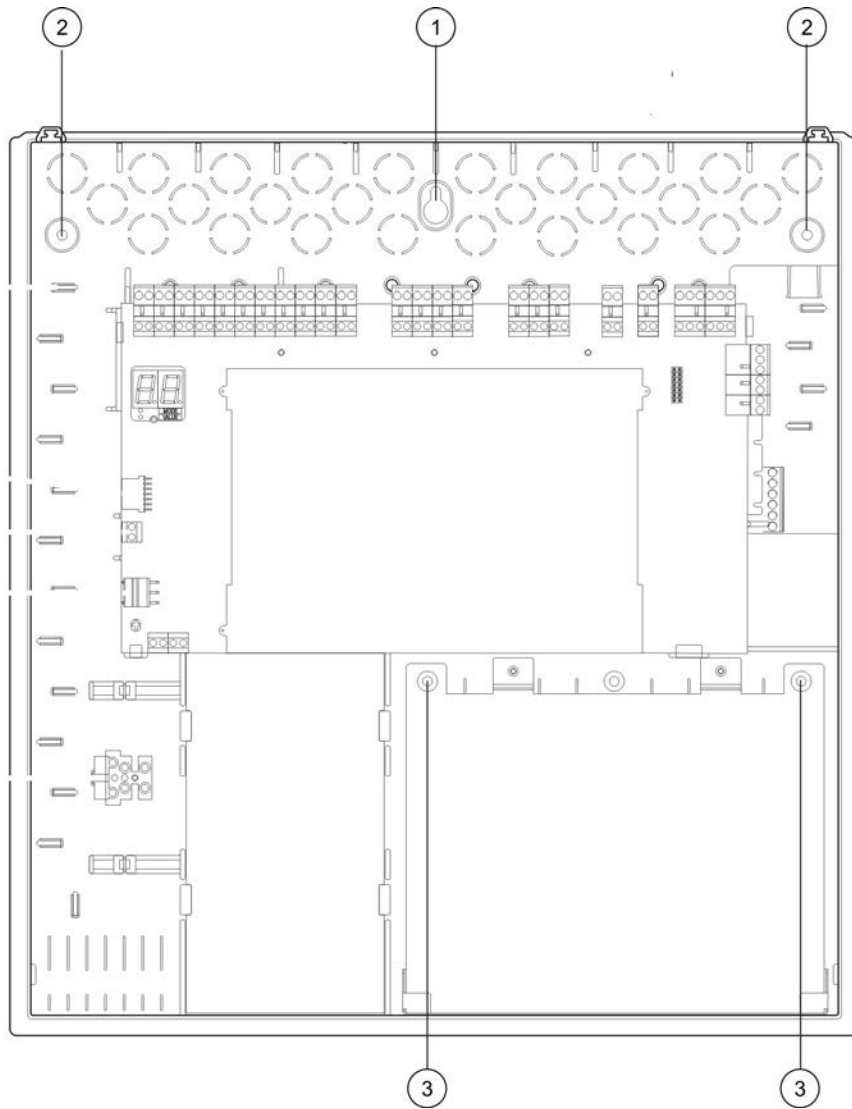
Allow for enough floor and wall space so the panel can be installed and serviced without any obstructions. The cabinet should be mounted so that the user interface is at eye level.

Note that the control panel must be assembled and installed according to the ordinances and codes that are in effect in your market or region.

Fixing the cabinet to the wall

Fix the cabinet to the wall using five M4 × 30 screws and five 6 mm diameter wall plugs, as shown below.

Figure 2: Mounting hole locations



To fix the control panel cabinet to the wall:

1. Mark drill points on the wall, using the cabinet as a template.
2. Drill all required holes and insert a 6 mm wall plug into each.
3. Insert a screw in position (1) and hang the cabinet onto this screw.
4. Insert screws in positions (2) and tighten.
5. Insert screws in position (3) and tighten.
6. Tighten screw in position (1).

Connections

WARNING: Electrocutation hazard. To avoid personal injury or death from electrocution, do not make any control panel or system connections while the control panel is connected to the mains power supply.

Recommended cables

Recommended cables for optimal system performance are shown in the table below.

Table 2: Recommended cables

Cable	Cable description	Cable length
Mains cable	3 x 1.5 mm ²	N/A
Zone cable (mixed zone)	Twisted-pair (40 Ω and 500 nF max.) 12 to 26 AWG (0.13 to 3.31 mm ²)	2 km max.
Zone cable (automatic or manual zones)	Twisted-pair (55 Ω and 500 nF max.) 12 to 26 AWG (0.13 to 3.31 mm ²)	2 km max.
Fire network cable	Twisted-pair, Cat 5 12 to 26 AWG (0.13 to 3.31 mm ²)	1.2 km max.

Note: Other types of cable may be used subject to site-specific EMI conditions and installation testing.

Use 20 mm cable glands to ensure clean and secure connections at the control panel cabinet. All cables should be fed through the cable guides in the cabinet housing to eliminate movement.

Connecting zones with initiating devices

Zone configuration

The control panel has three fire detection zone inputs, marked Z1, Z2, and Z3 on the control panel PCB to define the extinguishing area.

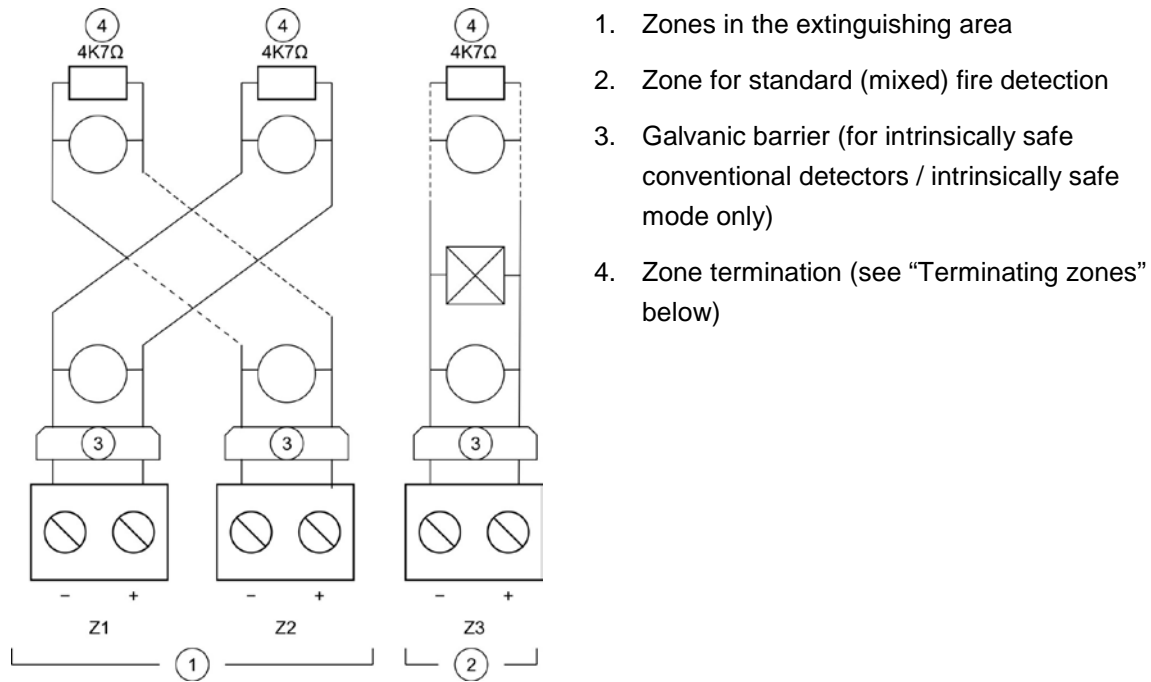
By default, Z1 and Z2 cover the extinguishing area and are configured for automatic detection of an extinguishing event. (Both zones must be in fire alarm condition to determine an extinguishing event.) The default configuration for Z3 provides standard fire detection as a mixed zone (using automatic or manual fire alarm detection).

Additional zone configuration options are available - see “Extinguishing zones” on page 45 more information.

Connecting zones

Figure 3 below shows connections for the default configuration (option 2).

Figure 3: Connecting zones for the default configuration



Line resistance

Line resistance is shown in the following table.

Table 3: Zone line resistance values

Zone type	EN 54-2, BS 7273	EN 54-13	Intrinsically safe
Mixed detection	40 Ω max.	Not supported [1]	Not supported [1]
Automatic detection	55 Ω max.	50 Ω max	50 Ω max
Manual detection	55 Ω max.	50 Ω max	50 Ω max

[1] Mixed zones are not permitted in installations requiring EN 54-13 or intrinsically safe configurations.

To measure the line resistance:

1. Disconnect all zone devices.
2. Create a short circuit at the end of the zone line.
3. Measure the resistance between the positive and negative lines with a multimeter.

Terminating zones

Zone termination is required at all times, whether the zone is used or not. The type of termination depends on the installation, as shown below.

Table 4: Zone termination

Installation type	Termination
EN 54-2	4.7 k Ω , 5%, 1/4 W end-of-line resistor
BS 7273	Active end-of-line device (see note below)
EN 54-13	EOL-Z end of line device (polarity sensitive)
Intrinsically safe	4.7 k Ω , 5%, 1/4 W end-of-line resistor

Note: For BS 7273 installations an active end-of-line device must be installed (instead of an end-of-line resistor). Unused zones must be terminated with an active end-of-line device or configured as passive end-of-line and terminated with a 4.7 k Ω , 5%, 1/4 W end-of-line resistor.

The type of zone termination can be configured on a zone-by-zone basis. See “Zone configuration” on page 55. Advanced installer user level access is required.

Connecting fire detectors

Connect detectors as shown in Figure 3 on page 8.

The panel supports conventional detectors. To guarantee optimal operation, use the detectors specified in the compatibility list. For more information on fire detectors, see Chapter 5 “Technical specifications” on page 79.

Note: For BS 7273 installations a diode must be connected on the detector base (see your detector installation manual for more details).

Connecting fire alarm manual call points

Connect fire alarm manual call points in parallel. Each fire zone can support a maximum of 32 manual call points.

In zones used for fire detection, manual call points must have a resistance installed in series with the normally open (NO) contact for activation. This avoids reporting a short circuit fault and allows identification of the alarm type (automatic or manual) based on the impedance.

In zones used for the extinguishing area, alarms are always reported as automatic (detector), but indications may vary for other panels in a network. A series impedance is also required to avoid reporting a short circuit fault.

The resistance required depends on the zone type, as shown in the table below. Resistance must be rated at 1 W minimum.

Table 5: Fire alarm manual call point resistance values

Zone type	EN 54-2, BS 7273	EN 54-13	Intrinsically safe
Mixed detection	100 Ω	Not supported	Not supported
Manual detection	100 to 680 Ω	100 to 470 Ω	250 to 560 Ω

Connecting inputs

Input functionality

Each control panel has eight inputs, marked IN1 to IN8 on the control panel PCB. Input functionality is shown in the table below.

Table 6: Input functionality

Input	Function	Supervision
IN1	Start extinguishing manual call point	Supervised
IN2	Hold extinguishing manual call point	Supervised
IN3	Abort extinguishing manual call point Disable extinguishing switch (BS 7273 mode)	Supervised
IN4	Manual-only mode activation device	Unsupervised
IN5	Low pressure indication	Supervised
IN6	Extinguishing agent flow	Supervised
IN7	Safety door fault monitoring	Supervised
IN8	Remote reset	Unsupervised

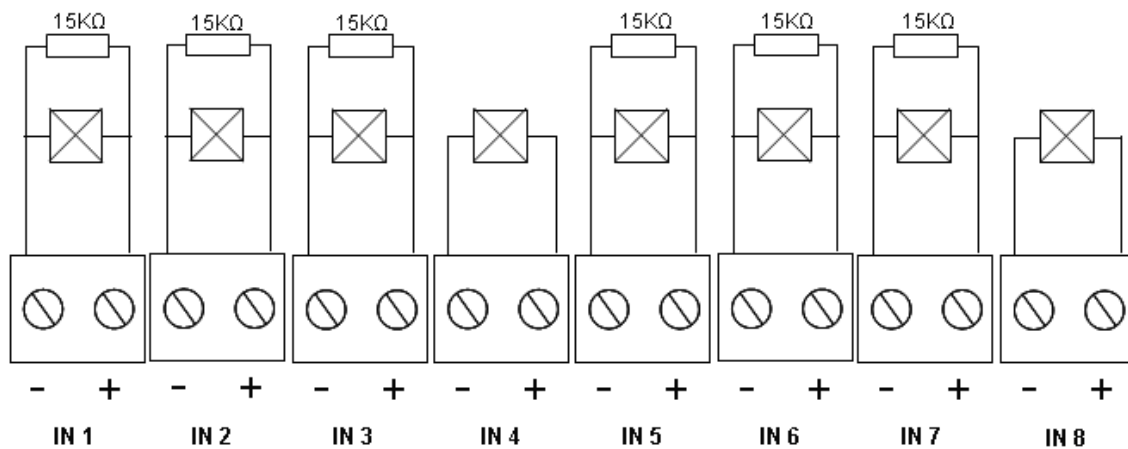
Input termination

Only supervised inputs require a 15 kΩ, 5%, 1/4 W end-of-line resistor for termination. If a supervised input is not used, the end-of-line resistor must be installed across the unused terminals.

Connecting inputs

Connect inputs IN1 to IN8 as shown below.

Figure 4: Connecting inputs



See “Input and output specifications” on page 81 for the input circuit parameters.

Connecting extinguishing system manual call points

The manual call point inputs require an activation impedance between 100 and 620 Ω , 2 W. These are normally connected in series with a normally open (NO) contact. An end-of-line resistance of 15 k Ω is required.

When the abort extinguishing or hold extinguishing manual call points are activated, the control panel activates the related relay outputs on the main board.

Note: MCP Hold faults and MCP Abort faults prevent the panel from entering the extinguishing activation state (because of life safety issues) and from activating the actuator (to ensure property protection).

The extinguishing system supports three types of manual call point (MCP):

- MCP Start
- MCP Hold
- MCP Abort

Descriptions of each MCP type follow.

MCP Start. Starts the extinguishing process. When the panel is in the standby, extinguishing preactivation, or fire alarm state, activation of this device puts the panel in the extinguishing activation state.

The control panel can be configured to bypass any actuator delay and to activate the actuator immediately on entering the extinguishing activation state. To configure this, set the “Actuator delay for Start MCP” to OFF.

MCP Hold. Holds the extinguishing process. When the panel is in the extinguishing activation state, the actuator output is not activated while the MCP Hold device is activated (continuously). The MCP Hold input can be configured for two different operating modes, Mode A and Mode B.

Table 7: MCP Hold operating modes

Mode	Description
Mode A	<p>When the MCP Hold is activated, the actuator delay countdown continues, but the panel is prevented from entering the extinguishing activation state. When the MCP Hold is deactivated, the delay countdown determines when the panel enters the extinguishing activation state.</p> <p>In this mode, activation of the MCP Hold turns on the MCP Hold LED, which stays on until the panel is manually reset. The yellow Preactivation LED flashes to indicate that the panel is being prevented from entering the extinguishing activation state. The Preactivation LED flashes to show when the MCP Hold is on; it turns off when the MCP Hold is off.</p>
Mode B	<p>When the MCP Hold is activated, the actuator delay countdown stops, putting the extinguishing release process on hold. The sounders emit a unique sound pattern (1 second on, 4 seconds off) while the extinguishing release process is on hold. When the MCP Hold is deactivated, the delay countdown restarts and the sounder pattern changes to the tone configured for extinguishing activation. The MCP Hold LED turns off when the MCP Hold device is deactivated.</p>

See “Hold mode” on page 43 for instructions on setting the MCP Hold operating mode.

MCP Abort. Aborts the extinguishing process. During the standby, extinguishing preactivation, extinguishing activation, and fire alarm states, activating the MCP Abort device prevents the extinguishing process until the MCP Abort device is deactivated and the control panel is reset.

Connecting a disable extinguishing switch

Use the disable extinguishing input IN3 (BS 7273 mode) to disable the extinguishing process remotely (requires operator level access).

Connecting an external device for manual-only mode control

When the control panel is in manual-only mode, the extinguishing process can only be initiated manually, using the MCP Start device. Automatic extinguishing events reported by the fire detection zones are disabled for extinguishing activation.

This mode of operation can be used when the user interface is not suitable for your application and a remote control is needed.

A manual-only mode input device is used to switch the panel to this mode. In addition to connecting a manual-only mode activation device, you must configure the system by setting the “Manual-only mode local” option to OFF.

Note: EU ordinances and regulations require the use of a key switch to control access to this function.

See “Input and output specifications” on page 81 for the required impedance values for this unsupervised input.

Connecting a low pressure indication switch

Use the low pressure indication input to detect low pressure in the extinguishing agent container.

The “Pressure switch type” option defines whether the device detects low pressure when open or when closed. In the device standby state, either normally open or normally closed, the input is not interpreted as a low pressure fault. The default setting is normally closed (NC). This results in a low pressure fault when the switch opens.

See “Input and output specifications” on page 81 to see how the low pressure indication device impedance is related to the low pressure fault.

Connecting an extinguishing agent flow device

Use the extinguishing agent flow input to connect a device that detects the release of the extinguishing agent from its container into the extinguishing area.

Note: Before you connect a device to the extinguishing agent flow input, make sure that it is compatible with the required input impedance levels of the control panel, as specified in “Input and output specifications” on page 81.

The “Extinguishing agent flow” option lets you define the functionality of this device. Here are the details.

When the extinguishing agent flow option is set to OFF, the panel enters the extinguishing released state when the actuator output is activated. The panel does not require confirmation of the flow to enter this state. The extinguishing agent flow circuitry continues to operate for indication purposes. The panel will not enter the release state when the extinguishing agent flow device is active without first entering the extinguishing activation state (that is, when an extinguishing event is detected).

When the extinguishing agent flow option is set to ON, the control panel can enter the extinguishing released state from any state, once the extinguishing agent flow device is activated. In extinguishing released state, the panel activates all corresponding outputs, except for the actuator output.

Connecting a safety door fault monitoring device

The safety door fault monitoring input lets the panel monitor a door in the extinguishing area. The monitored door becomes a *safety door*.

A safety door fault means that the door is in a position that will prevent the release process, given the current operating mode of the panel. A safety door fault prevents the panel from entering the extinguishing activation state (because of life safety issues) and activating the actuator (to ensure property protection).

When the panel is in manual-only mode, the safety door must be open. A closed door signal is interpreted as a fault.

When the panel is in manual-automatic mode, the safety door must be closed. An open door signal is interpreted as a fault.

You can configure a delay before the panel interprets a safety door monitor signal as a fault. This allows for momentary opening or closing of the door for routine traffic. The delay is bypassed when the panel enters the extinguishing activation or extinguishing released states.

By default, the control panel is configured for basic applications which do not use this monitoring function. If your installation requires it, activate the function by setting the “Safety door monitoring” option to ON, and specifying a “Safety door fault delay” between 10 and 90 seconds.

Here are the operating details of the function.

When the panel is not in extinguishing activation or extinguishing released states:

- For manual-automatic mode, the panel reports a fault if the door is open and the door fault delay expires
- For manual-only mode, the panel reports a fault if the door is closed and the door fault delay expires

When the system is in extinguishing activation or extinguishing released states, no matter which operating mode, the panel reports a fault if the door is open.

Connecting a remote reset device

The remote reset input allows the control panel to be reset from a remote location. The reset operation is the same as using the Reset button on the control panel user interface.

Note: EU ordinances and regulations require the use of a key switch to control access to this function.

The remote reset is executed when the input device switches from deactivated to activated. See “Input and output specifications” on page 81 for the impedance values for this unsupervised input.

Connecting outputs

Output functionality

Each control panel has eight outputs, marked OUT1 to OUT8 on the control panel PCB. Output functionality is shown in Table 8 below.

Table 8: Output functionality

Output	Function	Type and status
OUT1	Hold extinguishing manual call point	Free-of-voltage (unsupervised switch) Hold inactive = open Hold active = closed
OUT2	Abort extinguishing manual call point	Free-of-voltage (unsupervised switch) Abort inactive = open Abort active = closed
	Disable extinguishing switch (BS 7273 mode)	Free-of-voltage (unsupervised switch) Enabled = open Disabled = closed
OUT3	Manual-only mode	Free-of-voltage (unsupervised switch) Manual-automatic = open Manual-only = closed
OUT4	Extinguishing released	Free-of-voltage (unsupervised switch) Released inactive = open Released = closed
OUT5	Fire sounders	Supervised (standard) Off = -11 VDC (supervision) On = +24 VDC
OUT6	Extinguishing sounders	Supervised (standard) Off = -11 VDC (supervision) On = +24 VDC
OUT7	Extinguishing released optical warning panels or signs	Supervised (standard) Off = -11 VDC (supervision) On = +24 VDC

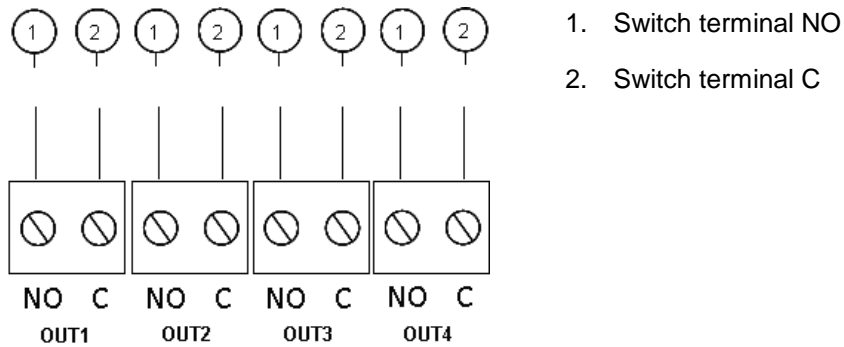
Output	Function	Type and status
OUT8	Extinguishing actuator	Supervised (extinguishing EOL) Off = -11 VDC (supervision) On = +24 VDC

Connecting free-of-voltage outputs

These outputs use the normally open (NO) and the common (C) terminals of a relay to provide the free-of-voltage, isolated, unsupervised switch functionality. When the output is in standby the NO and C terminals are open. When the output activates, the relay changes to close the NO and C terminals.

The maximum rating per active output is 2 A at 30 VDC.

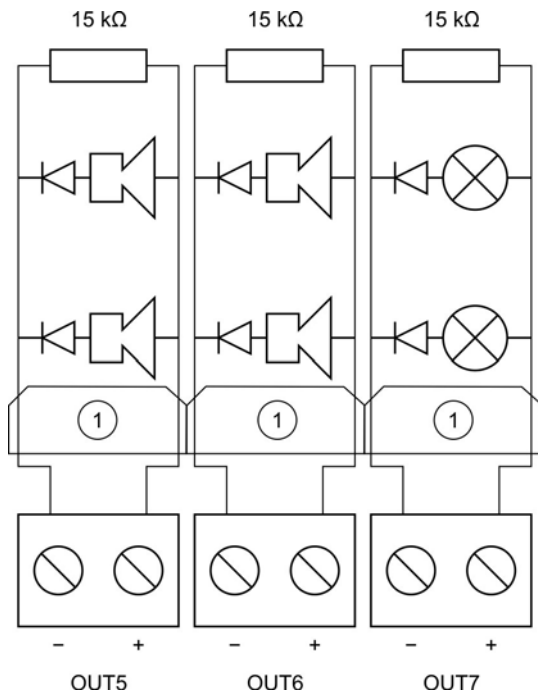
Figure 5: Control panel free-of-voltage outputs



Connecting standard supervised outputs

All standard supervised outputs require a 15 kΩ, 5%, 1/4 W end-of-line resistor as termination for proper detection of wiring problems (open or short circuit). If an output is not used, the end-of-line resistor must be installed across the unused terminals.

Figure 6: Control panel standard supervised outputs



1. Galvanic barrier for intrinsically safe fire output

Standard supervised outputs provide -11 VDC in standby and +24 VDC when active (nominal values). See Chapter 5 “Technical specifications” on page 79 for the details on the maximum current rating.

Note: Standard supervised outputs are polarity sensitive. Observe polarity or install a 1N4007 diode or equivalent to avoid inverted activation issues.

Connecting the extinguishing actuator output

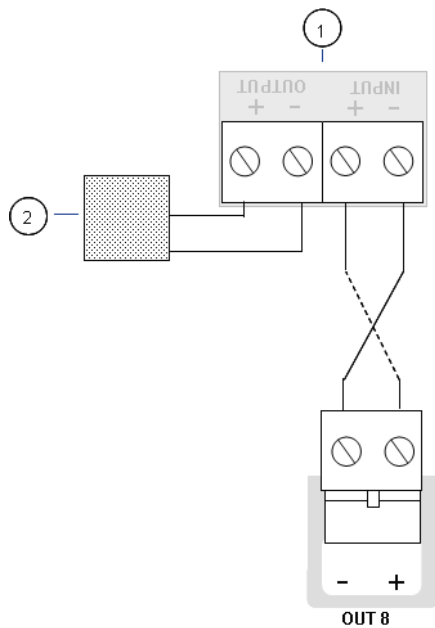
Note: Observe the polarity of the extinguishing actuator output to ensure proper operation.

WARNING: Risk of death or serious injury. Test the line supervision (for open and short circuit faults) and the activation function *before* connecting the extinguishing agent to the actuator.

The extinguishing actuator output is the most critical output of the system, as it controls the release of the extinguishing agent into the extinguishing area.

A special end-of-line circuit (the 2010-1EXT-EOL board) is required for proper operation so that the wiring to the extinguishing agent actuator is supervised.

Note: To ensure reliable operation, locate the end-of-line board as close as possible to the extinguishing actuator device.

Figure 7: Control panel extinguishing actuator connection

1. 2010-1EXT-EOL board
2. Extinguishing actuator device

Connecting the mains power supply

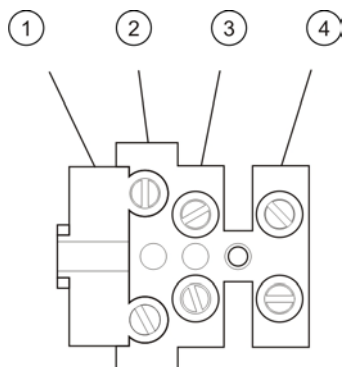
Note: To avoid unwanted arcing, connect the mains power supply before connecting the batteries.

The control panel can be operated at 110 VAC / 60 Hz or 240 VAC / 50 Hz (+10% or -15%).

Mains power should be sourced directly from a separate circuit breaker in the building electrical supply distribution board. This circuit should be clearly marked, have a bipolar disconnect device, and only be used for fire detection equipment.

Feed all mains cables through the appropriate cable knockouts and connect them to the fuse terminal block as shown in Figure 8 below.

Keep mains cables separate from other cabling to avoid potential short circuits and interference. Always secure mains cables to the cabinet to prevent movement.

Figure 8: Connecting the mains power supply

1. Mains fuse
2. Live
3. Earth
4. Neutral

For fuse specifications, see “Power supply specifications” on page 83.

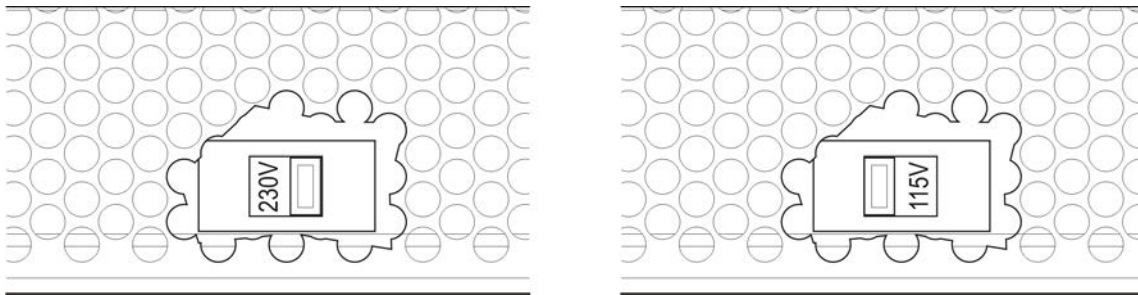
Selecting 115 or 230 VAC operation

WARNING: Electrocution hazard. To avoid personal injury or death from electrocution, remove all sources of power and allow stored energy to discharge before installing or removing equipment.

The default power setting is 230 VAC. For 115 VAC operation change the power setting switch, located on the side of the power supply unit, as shown in Figure 9 below.

Caution: Risk of equipment damage. An incorrect power setting can destroy the power supply.

Figure 9: Selecting 115 or 230 VAC operation



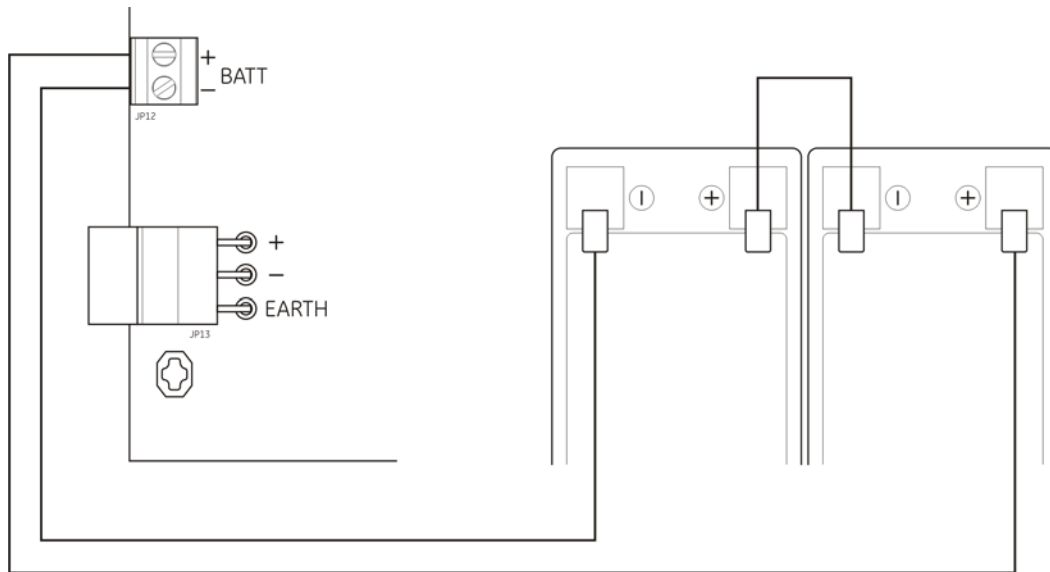
Connecting the batteries

The control panel requires two 12 V, 7.2 or 12 Ah rechargeable, sealed, lead-acid batteries.

Batteries must be installed in series, at the base of the control panel cabinet. Use the battery lead and bridge provided and connect batteries to the BATT connector on the control panel PCB, as shown below. Polarity must be observed.

Note: If the control panel indicates a Supply Fault, then the batteries may need to be replaced. See “Battery maintenance” on page 77.

Figure 10: Connecting the batteries



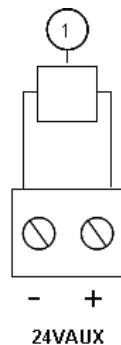
Caution: Risk of equipment damage. No other equipment may be connected to the BATT connector.

Connecting other equipment

Connecting auxiliary equipment

Connect auxiliary equipment to the 24VAUX output as shown in Figure 11 below. The 24 VDC auxiliary output is supervised for short circuit and voltage output.

Figure 11: Auxiliary power supply output connection (24VAUX)



1. External equipment to be powered with 24 VDC

See Table 28 on page 83 for the maximum current and other output ratings.

Caution: Never use the auxiliary output to power expansion boards connected to the same control panel as this might damage the control panel hardware.

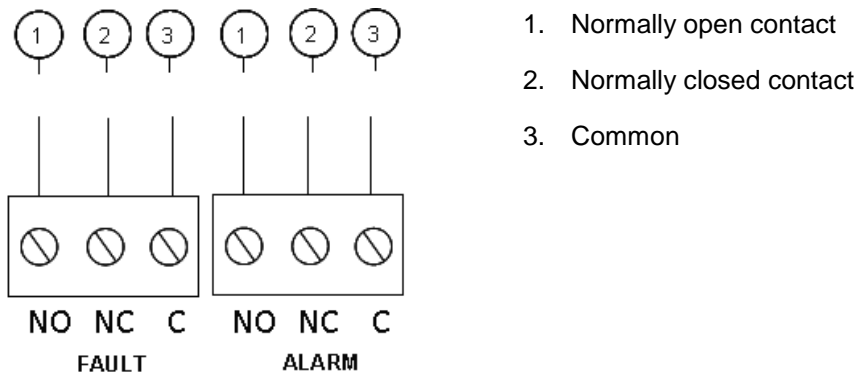
Connecting alarm and fault relays

Connect alarm and fault equipment to the ALARM and FAULT relays.

Each potential-free relay output is activated in the corresponding alarm or fault situation. The fault relay output is activated when there is no fault. This means that there is a short circuit between the common (C) and normally open (NO) terminals of the relay.

The maximum contact rating for each relay circuit is 2 A at 30 VDC.

Figure 12: Fault and alarm relay output connections



Connecting expansion boards

Caution: Risk of equipment damage. Always disconnect the control panel from the mains power supply before installing an expansion board.

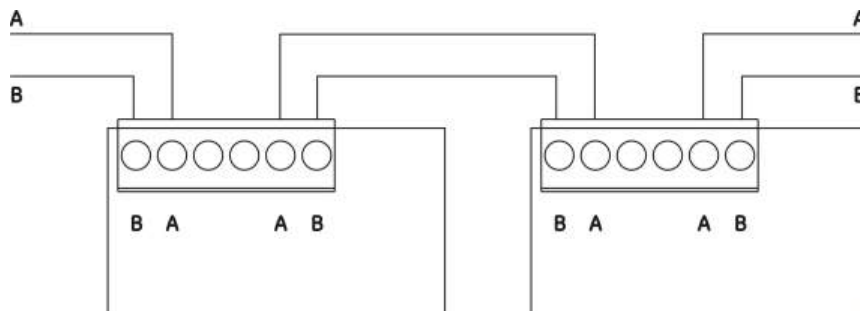
See your expansion board installation sheet for detailed installation information.

Connecting a fire network

Note: See the 2010-1-NB Network Board Installation Sheet for detailed installation and connection information.

Each 2010-1-NB network board has two ports. Each port is connected (point to point) to the corresponding ports of the network board in another control panel.

Figure 13: Network board connections



Two wiring options are possible:

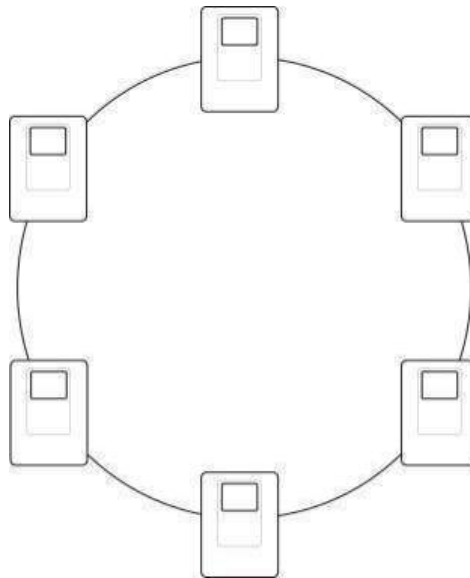
- Ring configuration
- Bus configuration

Ring configuration

Ring network configuration is recommended as it provides for redundancy in the transmission path.

For ring configuration (Class A), use both ports to connect all network boards or control panels to form a ring, as shown below.

Figure 14: Fire network ring configuration



Bus configuration

Note: To be compliant with EU regulations, use this network configuration only in cases where the detection zones and mandatory EN 54-2 output functions (sounder and fire routing outputs) are not remote between panels.

Bus network configuration is not normally recommended, as it does not provide for redundancy in the transmission path.

For bus configuration (Class B), connect control panels as shown below.

Figure 15: Fire network bus configuration



Chapter 3

Configuration and commissioning

Summary

This chapter includes information on how to configure and commission the control panel. Configuration is divided in basic configuration and advanced configuration options.

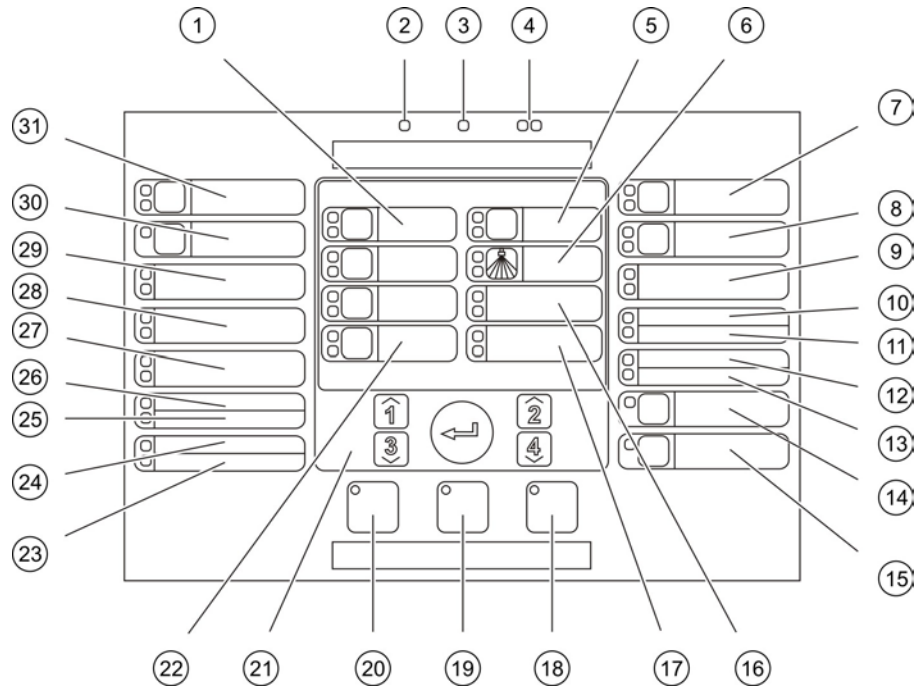
Content

- The user interface 25
- User levels 26
- Configuration overview 27
 - Configuration controls 27
 - Common configuration tasks 29
- Basic configuration 31
 - The basic configuration menu 31
 - Basic default configuration 32
 - Supervision mode 33
 - Panel mode 33
 - Actuator delay 34
 - Reset disabled delay 35
 - Fire sounders delay 35
 - Fire routing delay 36
 - Fire delay operation 36
 - Adding expansion boards 37
- Advanced configuration 37
 - The advanced configuration menu 37
 - Safety door monitoring 42
 - Safety door fault delay 42
 - Pressure switch type 43
 - Hold mode 43
 - Activation tone 44
 - Released tone 44
 - Extinguishing zones 45
 - Manual-only mode local 46
 - Manual key mode 47
 - Enable flooding time 48
 - Flooding time 49
 - Actuator delay for start manual call point 50
 - Extinguishing agent flow 50
 - Fire sounder operation during a zone test 51
 - Fire sounder re-sound 52
 - Fire sounders silence disabled time 52
 - Battery fault check 53
 - Earth fault check 54
 - Fault latch 54
 - Zone configuration 55
 - Zone delay 56
 - Zone type 56
 - Changing user level passwords 57
 - Auxiliary 24 V reset 58
 - Configuration, software, and PCB identification 59

Expansion board configuration	60
Adding an expansion board	60
Expansion board configuration	60
Fire network and repeaters configuration	62
Basic configuration options	62
Advanced configuration options	65
Commissioning	70
Before commissioning the control panel	70
Commissioning the control panel	71
Functional tests	72
Response times	73

The user interface

Figure 16: The user interface



- | | |
|--|---|
| 1. Zone buttons and LEDs (Z1, Z2, Z3) | 16. Low Pressure LEDs |
| 2. Supply LED | 17. Extinguishing Agent Flow LEDs |
| 3. General Fault LED | 18. Reset button and LED |
| 4. General Fire Alarm LEDs | 19. Panel Silence button and LED |
| 5. Preactivation button and LEDs | 20. Fire Sounders Start/Stop button and LED |
| 6. Released LEDs | 21. Numeric keypad and Enter button |
| 7. Extinguishing Sounders On button and LEDs | 22. Manual Mode button and LED |
| 8. Fire Sounders Delay button and LEDs | 23. System Fault LED |
| 9. Optical Panel On LEDs | 24. Out of Service LED |
| 10. Door Fault/Disabled LED | 25. Earth Fault LED |
| 11. Networking Fault LED | 26. Supply Fault LED |
| 12. Service Detector LED | 27. MCP Abort LEDs |
| 13. Expansion I/O Fault/Disabled LED | 28. MCP Hold LEDs |
| 14. General Disable button and LED | 29. MCP Start LEDs |
| 15. General Test button and LED | 30. Fire Routing Delay button and LED [1] |
| | 31. Fire Routing On button and LEDs [1] |

[1] Fire routing is only available if a 2010-1-SB expansion board is installed and fire routing functionality is configured.

BS 7273 user interface

For control panels configured for BS 7273, the labels for some interface buttons change, as shown in the table below.

Table 9: Configured changes to interface buttons and LEDs

Item	BS 7273 user interface
22	Auto/Manual mode and Only Manual mode button and LEDs
27	Extinguishing disabled switch LEDs

User levels

For your safety, access to some features of this product are restricted by user levels. The access privileges of each user level are described below.

The configuration tasks described in this chapter can only be performed by an installer user level, either basic or advanced. These user levels are reserved for the installation contractors authorized and responsible for the system installation and configuration.

Public user

The public user level is the default user level.

This level allows basic operating tasks, such as responding to fire alarms, extinguishing events, or fault warnings at the control panel. No password is required.

Operator user

The operator user level allows additional operating tasks that command the system or perform maintenance functions. It is reserved for authorized users who have been trained to operate the control panel.

Consult the operation manual for more details on the functions available for public user and operator user levels.

Basic installer user

The basic installer user level allows the quick configuration of basic installation options that cover most applications.

Advanced installer user





The advanced installer user level allows the detailed configuration of very specific applications where the advanced features provided by the control panel are required. This level is also required for installers that require minor customizations after configuring a basic installation.

Passwords and indications for each user level are described in “User level passwords and indications” below.

User level passwords and indications

The default user level passwords and the corresponding LED and seven-segment display indications are shown in Table 10 below. The seven-segment display is only visible when the control panel cover is removed. Figure 1 on page 4 shows the location of the seven-segment LED.

Table 10: User level passwords and indications

User level	Password	LED	Default display	Custom display
Public	None	None	None	None
Operator	2222	The Reset LED is steady	None	None
Basic installer	3333	The Reset LED is flashing fast		
Advanced installer	4444	The Reset LED is flashing fast		

Note: If you have used advanced configuration options to set a custom zone delay, zone configuration, or zone type, then the seven-segment display defaults to the custom display operating mode. See “Panel mode” on page 33.

Configuration overview

To facilitate rapid configuration of the most common tasks, configuration is divided into basic and advanced levels.

For basic configuration options, see “Basic configuration” on page 31. For advanced configuration options see “Advanced configuration” on page 37.

Note: The Reset and Panel Silence functions are not available when you are in configuration mode. To reset the control panel or silence the internal buzzer, first exit from configuration mode. See “Common configuration tasks” on page 29 for instructions on exiting from configuration mode.

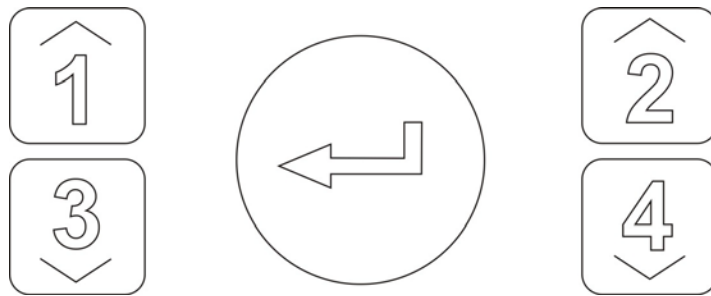
Configuration controls

The control panel is configured using the front panel configuration controls and the seven-segment display.

The configuration controls

The configuration controls are located on the control panel interface.

Figure 17: Front panel configuration controls



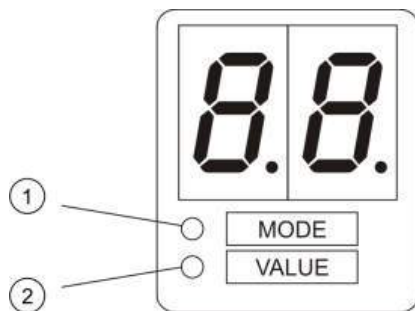
Button	Function
1	Scroll to the next configuration menu on the seven-segment display.
2	Scroll to the next configuration value for the active menu on the seven-segment display.
3	Scroll to the previous configuration menu on the seven-segment display.
4	Scroll to the previous configuration value for the active menu on the seven-segment display.
Enter	Confirm a menu selection or a value selection entry.

Note: The configuration controls are also used to enter the user level password.

The seven-segment display

The seven-segment display is only visible when the control panel cover is removed (see Figure 1 on page 4).

Figure 18: The seven-segment display



1. Mode LED
2. Value LED

Table 11: Mode and value LEDs

LED	Indications
Mode	Select a configuration menu using buttons 1 and 3 when this LED is steady, or Select a configuration submenu using buttons 1 and 3 when this LED is flashing.
Value	Select a configuration value using buttons 2 and 4 when this LED is steady

Common configuration tasks

To enter configuration mode:

1. Remove the control panel cover so that the seven-segment display is visible.
2. Enter a valid installer user level password (3333 for basic configuration or 4444 for advanced configuration).
3. Press Enter.

When first entering configuration mode, the Mode LED on the seven-segment display is steady. For other indications, see Table 11 on page 28.

To select a menu:

1. Select the required menu using the menu selection buttons (1 and 3).
2. Press Enter.

When a configuration menu has been selected, the Value LED on the seven-segment display is steady.

To select a value:

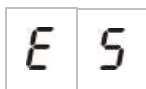
1. Select the required value using the value selection buttons (2 and 4).
2. Press Enter.

To exit configuration mode and save your changes:

1. Press Panel Silence.
2. Press Enter.

— or —

1. Set the display as shown below, and then press Enter.



The Panel Silence LED flashes to confirm that a configuration change has been applied.

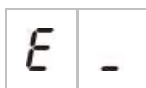
Note: Make all required configuration changes before exiting configuration mode and saving your changes.

To exit configuration mode without saving your changes:

1. Press Reset

— or —

1. Set the display as shown below, and then press Enter.



The control panel will exit configuration mode after 5 minutes if no button is pressed.

Visible indications for current value and selected value

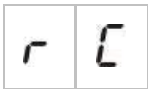
Current and selected values are indicated as follows.

Table 12: Visible indications for values

Status	Indication
Current value	Both decimal points on the display are steady
New selected value	Both decimal points on the display are flashing
Other value	Both decimal points on the display are off

To restore the previous configuration:

1. Set the display as shown below, and then press Enter.



To restore the factory configuration:

1. Set the display as shown below, and then press Enter.



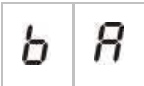
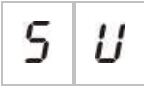







Basic configuration





The default password for basic configuration is 3333. After entering the password, the first displayed menu will be Basic default configuration (indicating the basic installer user level). For more information see “User level passwords and indications” on page 27.

The basic configuration menu

Configuration options for this menu are shown in the table below. More information for each option is included in the related topic.

Table 13: The basic configuration menu

Display	Menu	Values
	Basic default configuration	01, 02, 05, 06, 11,12, 13, 14, 61, 63
	EN 54-13 supervision	Of= EN54-13 supervision Off and class B outputs A= EN54-13 supervision On for zone and class A expansion board outputs Default: Off
	Panel mode	Basic standard Basic evacuation BS 7273 mode stage 1 BS 7273 mode stage 2 Repeater with fire routing (EN 54-2) Repeater with fire routing (BS 7273) Custom
	Actuator delay	00 to 60 seconds Default: 10 seconds
	Reset disabled delay	00 to 30 minutes Default: 2 minutes
	Fire sounders delay	00 to 10 minutes Default: 0 minutes
	Fire routing delay	00 to 10 minutes Default: 0 minutes
	Add an expansion board [1]	00 to 04 modules Default: 0
	Firenet identifier [2]	0 to 32 0: Stand-alone (no networking) Default: 0

Display	Menu	Values
	Restore previous configuration	N/A
	Restore factory configuration	N/A
	Exit without saving	N/A
	Exit and save	N/A

[1] Additional menu options are available if one or more expansion boards are installed. See “Expansion board configuration” on page 60.

[2] Additional menu options are available if Firenet is configured. See “Fire network and repeaters configuration” on page 62.

Basic default configuration

Use this menu to select operating mode configuration presets.

In both basic standard and basic evacuation modes, zone detection is the same. The extinguishing area uses Z1 and Z2 (automatic). Fire detection uses Z3 (mixed).

Available presets are shown in the table below. The default setting is 01 (Basic standard mode, passive end-of-line).

Table 14: Operating mode configuration presets

Display	Mode	Zone configuration	Manual fire sounder start	Actuator delay for MCP Start
01 (default)	Basic standard	Passive end-of-line	No	Yes
02	Basic standard	Passive end-of-line, CleanMe enabled	No	Yes
05	Basic evacuation	Passive end-of-line	Yes (operator user level) [1]	No (bypassed)
06	Basic evacuation	Passive end-of-line, CleanMe enabled	Yes (operator user level) [1]	No (bypassed)
11	BS 7273 stage 1	Active EOL	No	Yes
12	BS 7273 stage 2	Active EOL	No	Yes
61	Repeater with fire routing (EN 54-2)	N/A	N/A	N/A
63	Repeater with fire routing (BS 7273)	N/A	N/A	N/A
00	Custom [2]	N/A	N/A	N/A

[1] A fire alarm is not required to activate the fire sounders.

[2] This option cannot be selected. It is displayed automatically when an advanced configuration is entered

To change the operation mode configuration preset:

1. Set the display as shown below, and then press Enter.



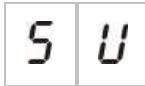
2. Select a value using the value selection buttons (2 and 4).
3. Press Enter.
4. Save your changes.

Supervision mode

Use this menu to configure the supervision mode.



To configure the supervision mode:

1. Set the display as shown below, and then press Enter.



2. Select a value using the value selection buttons (2 and 4). The Zone LEDs flashes fast to indicate that the supervision mode is active.
3. Press Enter.
4. Save your changes.

The available settings for this feature are shown below.

Display	Description
	EN 54-13 supervision On for zone and class A expansion board outputs.
	Standard zone supervision with class B fire outputs (default).

Note: This menu is not visible if the panel operational mode is BS 7273 (either stage 1 or stage 2) or includes CleanMe configuration. These options only allow standard EN 54-2 zone supervision with class B outputs.

Panel mode


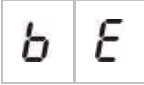




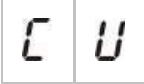
Use this read-only menu to view the operating mode of the control panel.

To view the panel mode:

1. Set the display as shown below, and then press Enter.



Display indications for each operating mode are shown below.

Display	Panel mode	Description
	Basic standard	Fire sounders cannot be manually activated (fire sounders are only activated if there is a fire alarm).
	Basic evacuation	Fire sounders can be manually activated at operator user level (a fire alarm is not required).
	BS 7273 mode stage 1	Fire sounders cannot be silenced automatically after the panel changes from pre-activated to activated state. They cannot be silenced automatically after the panel changes from 'Activated' to 'Released' state.
	BS 7273 mode stage 2	Fire sounders cannot be silenced automatically after the panel changes from pre-activated to activated state. They cannot be silenced automatically after the panel changes from 'Activated' to 'Released' state.
	Repeater with fire routing (EN 54-2)	Fire routing functionality can be repeated.
	Repeater with fire routing (BS 7273)	Fire routing functionality can be repeated.
	Custom	A custom operating mode is configured. The display alternates between CU (custom) and the operation mode.

Note: In basic evacuation operating mode, the configured actuator delay is bypassed when MCP Start is activated. The actuator output is activated immediately.

Custom panel operating mode

A custom panel operating mode will be indicated if any of the following zone configuration settings are changed from the operating mode preset values:

- Zone delay
- Zone configuration
- Zone type

Actuator delay

When the control panel enters the extinguishing activation state, the actuator delay starts counting down. The extinguishing actuator output is activated when the delay time expires. (Activation of the MCP Hold or MCP Abort point prevents the panel from entering the extinguishing activation state.)

Use this menu to configure an actuator delay of up to 60 seconds (in steps of 5 seconds). The default setting is for a 10-second delay.

To configure an actuator delay:

1. Set the display as shown below, and then press Enter.



The red Release LED flashes fast to indicate that the delay configuration menu is active.

2. Select a delay value from 00 to 60 seconds using the value selection buttons (2 and 4).
3. Press Enter.
4. Save your changes.

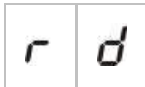
Reset disabled delay

When the control panel enters extinguishing activation, the reset disabled delay starts counting down, and the reset is disabled until the delay expires.

Use this menu to configure a reset disabled delay of up to 30 minutes (in steps of 1 minute). The default setting is for a 2-minute delay.

To configure a reset disabled delay:

1. Set the display as shown below, and then press Enter.



2. Select a delay value from 00 to 30 minutes using the value selection buttons (2 and 4).
3. Press Enter.
4. Save your changes.

Fire sounders delay

Use this menu to configure a fire sounders delay of up to 10 minutes. The default setting is 00 (no delay). For more information on delay operation, see “Fire delay operation” on page 36.

To configure a fire sounders delay:

1. Set the display as shown below, and then press Enter.



The Fire Sounders Delay LED flashes fast to indicate that the sounder delay configuration menu is active.

2. Select a delay value from 00 to 10 minutes using the value selection buttons (2 and 4).
3. Press Enter.
4. Save your changes.

Once configured the delay must be enabled at the operator user level.

To enable a configured delay:

1. Exit the installer user level.
2. Enter the operator user level password.
3. Press the Sounder Delay button.

A steady Sounder Delay LED indicates that the delay is enabled.

Fire routing delay

Use this menu to configure a fire routing delay of up to 10 minutes. The default setting is 00 (no delay). For more information on delay operation, see “Fire delay operation” below.

To configure a delay:

1. Set the display as shown below, and then press Enter.



The Fire Routing Delay LED flashes fast to indicate that the fire routing delay configuration menu is active.

2. Select a delay value from 00 to 10 minutes using the value selection buttons (2 and 4).
3. Press Enter.
4. Save your changes.

Once configured the delay must be enabled at the operator user level.

To enable a configured delay:

1. Exit the installer user level.
2. Enter the operator user level password.
3. Press the Fire Routing Delay button.

A steady Fire Routing Delay LED indicates that the delay is enabled.

Fire delay operation

Delays can be configured for fire sounders and for fire routing. These delays will only be applied when all of the following are true:

- The configured delay has been enabled
- The initiating device is a detector or a manual call point installed in an automatic zone or the initiating device is a detector installed in a mixed zone
- The initiating device is in a zone configured for delays (the default configuration)

If any of the above points are not true, then the control panel activates the fire sounders and fire routing immediately after the detection of the fire alarm.

Sounder delays are bypassed when the alarm is detected in an extinguishing zone.

Adding expansion boards

To add an expansion board to the system you must install the board and then configure the system. See the expansion board's installation guide for installation instructions. See "Expansion board configuration" on page 60 for configuration instructions.



Advanced configuration

The default password for advanced configuration is 4444. After entering the password, the first displayed menu is the Advanced default configuration (indicating advanced installer user level). For more information see "User level passwords and indications" on page 27.



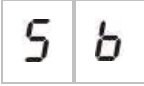
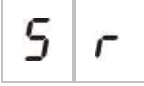
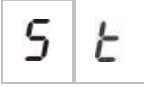
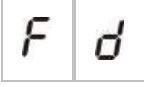

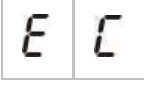
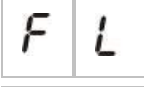


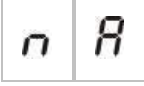

The advanced configuration menu

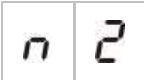

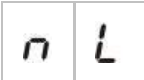
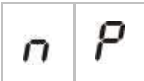

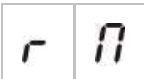
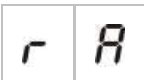

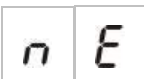
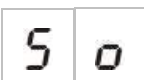
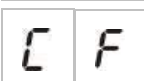
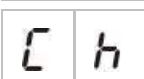


Configuration options for this menu are shown in the table below. More information for each option is included in the related topic.




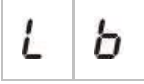

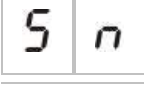
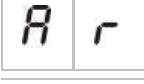
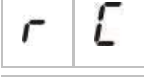


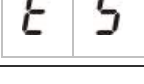
Table 15: The advanced configuration menu

Display	Menu	Values
	Advanced default configuration	See Table 14 on page 32
	EN 54-13 supervision	Of= EN54-13 supervision Off and class B outputs A= EN54-13 supervision On for zone and class A expansion board outputs Default: Off

Display	Menu	Values
	Panel mode	Basic standard Basic evacuation BS 7273 mode stage 1 BS 7273 mode stage 2 Repeater with fire routing (EN 54-2) Repeater with fire routing (BS 7273) Custom
	Actuator delay	00 to 60 seconds Default: 10 seconds
	Reset disabled delay	00 to 30 minutes Default: 2 minutes
	Safety door monitoring	ON/OFF Default: Off
	Safety door fault delay	10 to 90 seconds Default: 30 seconds
	Pressure switch type	Normally closed Normally open Default: Normally closed
	Activation tone	Pulsed Continuous Default: Pulsed
	Released tone	Pulsed Continuous Default: Continuous
	Extinguishing zones	Z1 extinguishing, Z2 and Z3 fire Z1 and Z2 extinguishing, Z3 fire Z1, Z2, and Z3 extinguishing No extinguishing zones, Z1, Z2, Z3 fire Default: Z1, Z2 – extinguishing, Z3 - fire
	Manual-only mode local	ON/OFF Default: On
	Hold mode	Mode A Mode B Default: Mode A
	Manual key mode	ON/OFF Default: Off
	Enable flooding time	ON/OFF Default: Off
	Flooding time	Minutes: 0 to 5 Seconds: 0 to 55 Default: 0 minutes and 0 seconds
	Actuator delay for start MCP	ON/OFF Default: On

Display	Menu	Values
	Extinguishing agent flow	ON/OFF Default: Off
	Fire sounders delay	00 to 10 minutes Default: 00
	Sounders operation during a zone test	ON/OFF Default: On
	Sounders re-sound	ON/OFF Default: On
	Silence sounders disabled time	00 to 10 minutes Default: 1 minute
	Fire routing delay	00 to 10 minutes Default: 00
	Battery fault check	ON/OFF Default: On
	Earth fault check	ON/OFF Default: On
	Fault latch	ON/OFF Default: On
	Module number	00 to 04 See "Expansion board function" on page 61.
	Firenet identifier	0 to 32 0: Stand-alone (no networking) Default: 0
	Firenet group. Allows you to configure the panel to work in a 32-node network or in a group of 32 nodes inside a 250-node network (0000-0250)	0000 to 0218 Default: 0000 The number has four digits. Identified by position, these are: 1234. Press Up to enter the first two digits of the number (positions 1 and 2). Press Down to enter the last two digits of the number (positions 3 and 4).
	Firenet analogue remote node	0000 to 0250 Default: 0000 The number has four digits. Identified by position, these are: 1234. Press Up to enter the first two digits of the number (positions 1 and 2). Press Down to enter the last two digits of the number (positions 3 and 4).
	Firenet number of nodes [1]	2 to 32 Default: 2

Display	Menu	Values
	Firenet initial zone number	0001 to 9999 Default: 0001 The number has four digits. Identified by position, these are: 1234. Press Up to enter the first two digits of the number (positions 1 and 2). Press Down to enter the last two digits of the number (positions 3 and 4).
	Firenet global controls	ON/OFF Default: On
	Firenet loop class	A/ B Default: B
	Process remote zones	ON/OFF Default: On
	Firenet map	01 to 32 ON/OFF On for nodes 1 and 2, Off for the rest
	Firenet repeater map	01 to 32 ON/OFF On for nodes 1 and 2, Off for the rest
	Firenet analogue repeater remote node	ON/OFF Default: Off
	Firenet remote output control	ON/OFF Default: Off
	Extinguishing Firenet global controls	ON/OFF Default: Off
	Software version	Read-only
	Configuration version	Read-only
	Configuration time stamp	Read-only
	Configuration date stamp	Read-only
	Zone configuration	Passive EOL Active EOL Passive EOL with CleanMe Active EOL with CleanMe Intrinsically safe Zenner EOL Unlatched (only for BS 7273 mode and fire zones)

Display	Menu	Values
	Zone delay	ON/OFF Default: On
	Zone type	Mixed Automatic Manual Default: Automatic (Z1, Z2), mixed (Z3)
	Operator user level password	0 to 4444 Default: 2222
	Basic installer user level password	0 to 4444 Default: 3333
	Advanced installer user level password	0 to 4444 Default: 4444
	Control panel PCB serial number	Read-only
	Auxiliary 24V reset	ON/OFF Default: Off
	Restore previous configuration	N/A
	Restore factory configuration	N/A
	Exit without saving	N/A
	Exit and save	N/A

Note: See “Basic configuration” on page 31 for details on the settings available in basic configuration: Panel mode, Actuator delay, Reset disabled delay, Fire sounders delay, and Fire routing delay. The default values defined above are for the Basic standard mode.

Safety door monitoring

Use this menu to configure safety door monitoring, on or off. The default setting is OF.

For a description of the safety door monitoring function, see “Connecting a safety door fault monitoring device” on page 13.

To configure safety door monitoring:

1. Set the display as shown below, and then press Enter.



The Door Fault LED flashes fast to indicate that the configuration menu is active.

2. Select a value using the value selection buttons (2 and 4).
3. Press Enter.
4. Save your changes.

The available settings for this feature are shown below.

Display	Description
	Safety door monitoring is used (on).
	Safety door monitoring is not used (off).

Safety door fault delay

Use this menu to configure a delay from 10 to 90 seconds (in steps of 5 seconds) in reporting safety door faults caused by incorrect status (open or closed). The default setting is 30 seconds.

To configure a safety door delay:

1. Set the display as shown below, and then press Enter.



The Door Fault/Disabled LED flashes fast to indicate that the delay configuration menu is active.

2. Select a delay value from 10 to 90 seconds using the value selection buttons (2 and 4).
3. Press Enter.
4. Save your changes.

Pressure switch type

Use this menu to configure the low pressure switch for detection of the container pressure. Correct pressure can be either normally closed (NC) or normally open (NO). The default setting is normally closed (NC).

To configure the pressure switch type:

1. Set the display as shown below, and then press Enter.



The Low Pressure LED flashes fast to indicate that the configuration menu is active.

2. Select a value using the value selection buttons (2 and 4).
3. Press Enter.
4. Save your changes.

The available settings for this feature are shown below.

Display	Description
	Operates as normally closed (NC).
	Operates as normally open (NO).

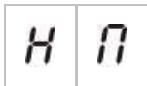
Hold mode

Use this menu to set the operating mode for this device (mode A or B). The default setting is mode A.

For a description of the emergency MCP Hold function and device, see “Connecting extinguishing system manual call points” on page 11.

To configure the emergency hold device mode:



1. Set the display as shown below, and then press Enter.



The MCP Hold LED flashes fast to indicate that the configuration menu is active.

2. Select a value using the value selection buttons (2 and 4).
3. Press Enter.
4. Save your changes.

The available settings for this feature are shown below.

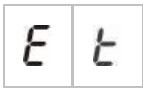
Display	Description
	Mode A: The actuator delay countdown continues during MCP Hold activation.
	Mode B: The actuator delay countdown restarts when the MCP Hold device is restored. MCP Hold is indicated using a specific sounder tone.

Activation tone

Use this menu to set the extinguishing activation tone of the extinguishing sounders on the control panel PCB: continuous or pulsed. The pulsed pattern is 1 second on, 1 second off. The default setting is pulsed mode.

To configure the activation tone:


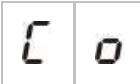
1. Set the display as shown below, and then press Enter.



The red Extinguishing Sounders LED flashes fast to indicate that the configuration menu is active.

2. Select a value using the value selection buttons (2 and 4).
3. Press Enter.
4. Save your changes.

The available settings for this feature are shown below.

Display	Description
	Pulsed mode
	Continuous mode

Released tone

Use this menu to set the extinguishing released tone of the extinguishing sounders on the control panel PCB: continuous or pulsed. The pulsed pattern is 1 second on, 1 second off. The default setting is continuous mode.

To configure the released tone:

1. Set the display as shown below, and then press Enter.



The red Extinguishing Sounders LED flashes fast to indicate that the configuration menu is active.

2. Select a value using the value selection buttons (2 and 4).
3. Press Enter.
4. Save your changes.

The available settings for this feature are shown below.

Display	Description
	Pulsed mode
	Continuous mode

Extinguishing zones

Use this menu option to define the extinguishing area required for your installation.

The control panel provides three fire detection zones that can be assigned for automatic detection of an extinguishing event. Fire detection zones that are not linked to the extinguishing area are assigned standard fire detection functionality. The configuration options available are shown in the table below.

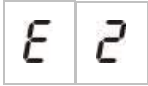
Table 16: Extinguishing zone options

Option	Zones	Description
1	Z1	An alarm in Z1 initiates the extinguishing event. The control panel provides standard fire detection for Z2 and Z3, both as mixed zones.
2	Z1 and Z2 (default)	Both Z1 and Z2 must be in alarm to initiate an extinguishing event. Z3 provides standard fire detection as a mixed zone.
3	Z1, Z2, and Z3	All three zones cover the extinguishing area. An alarm in any two of the zones initiates an extinguishing event. None of the zones provides standard fire detection functionality.
4	None	Only for fire. Extinguishing area is activated by an external event for the network. Z1, Z2 and Z3 provide standard fire detection as a mixed zone.

Note: For connection information, see “Connecting zones with initiating devices ” on page 7.

To configure the extinguishing zones:

1. Set the display as shown below, and then press Enter.



The Zone yellow LEDs flash quickly to indicate that the configuration menu is active.

2. Select a value using the value selection buttons (2 and 4).
3. Press Enter.
4. Save your changes.

The available settings for this feature are shown below.

Display	Description
	Z1 is configured as an extinguishing zone. Z2 and Z3 are configured as fire detection zones.
	Z1 and Z2 are configured as extinguishing zones. Z3 is configured as a fire detection zone.
	Z1, Z2, and Z3 are configured as extinguishing zones. No fire detection zones are provided.
	No extinguishing zones are provided. Z1, Z2, Z3 are configured as fire detection zones.

Manual-only mode local

When the control panel is in manual-only mode, the extinguishing process can only be initiated manually, using the MCP Start device. Automatic extinguishing events reported from the fire detection zones are disabled for extinguishing activation.

The panel can be switched to manual-only mode using two methods: by pressing the Manual Mode button on the control panel interface (local activation), or by a manual-only mode activation device, such as an external switch (remote input activation). A remote command can be transmitted from the network.

Use this option to configure which method is used to switch to manual-only mode. The default configuration is On (the Manual Mode button on the control panel interface is used for local activation).

For more information see “Connecting an external device for manual-only mode control” on page 12.

To configure the manual-only mode control:



1. Set the display as shown below, and then press Enter.



The yellow Manual Mode LED flashes fast to indicate that the configuration menu is active.

2. Select a value using the value selection buttons (2 and 4).
3. Press Enter.
4. Save your changes.

The available settings for this feature are shown below.

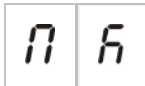
Display	Description
	Manual-only mode is set locally. Manual-only mode is activated by the Manual Mode button on the panel.
	Manual-only mode is set remotely. Manual-only mode is activated by the manual-only mode activation device.

Manual key mode

Use this menu to configure the manual key functionality if your control panel has a key switch installed in the door. The default setting is off.



To configure the manual key mode:

1. Set the display as shown below, and then press Enter.



2. Select a value using the value selection buttons (2 and 4).
3. Press Enter.
4. Save your changes.

The available settings for this feature are shown below.

Display	Description
	<p>Manual-automatic and manual-only mode.</p> <p>With this setting, the key functionality is as follows:</p> <ul style="list-style-type: none"> • If the key is turned to ON, the panel is set to Manual mode • If the key is turned to OFF, the panel is set to Automatic mode
	<p>Access level functionality (default).</p> <p>With this setting, the key functionality is as follows:</p> <ul style="list-style-type: none"> • If the key is turned to ON, operator level is active • If the key is turned to OFF, public level is active

Note

If the manual key mode setting is On, the key takes priority over the keypad and network related commands:

- If the key position is On (that is, the key is inserted and turned) the panel will stay in manual mode independently of the operator level auto/manual button actions on the keypad and related network commands.
- If the key position is OFF (that is, the key is not inserted or is inserted but not turned) the panel accepts an operator level request to change the auto/manual using the button or the related network commands.

Enable flooding time

Use this menu to enable the control of the flooding time. The flooding time is the time that the actuator remained activated (5 to 300 seconds in steps of 5 seconds). The default setting is off.

To enable the flooding time:

1. Set the display as shown below, and then press Enter.



The red Released LED flashes fast to indicate that the configuration menu is active.

2. Select a value using the value selection buttons (2 and 4).
3. Press Enter
4. Save your changes.

The available settings for this feature are shown below.

Display	Description
0 n	Flooding time is enabled.
0 F	Flooding time is disabled.

Flooding time

Use this menu to set the flooding time for the actuator (5 to 300 seconds in steps of 5 seconds). When the actuator is activated, the flooding time delay starts to run. When the flooding time expires, the actuator output is deactivated.

The default value is 0 min, 0 sec.

The maximum value is 5 min.

If the flooding time is set to 0 min, 0sec., the 'flooding time enable' will be set to OFF.

To configure the flooding time:

1. Set the display as shown below, and then press Enter.

F t

The red Released LED flashes fast to indicate that the configuration menu is active and nn (minutes) and SS (seconds) appears.

2. Select a value using the value selection buttons (2 and 4).
3. Press Enter
4. Save your changes.

The available settings for this feature are shown below.

Display	Description
n n	Setting the number of minutes (range is from 0 to 5).
S S	Setting the number of seconds (range is from 0 to 55).

Actuator delay for start manual call point

Use this menu to configure the control panel behaviour after a manual extinguishing event (from the MCP Start point): activate the actuator immediately or apply the actuator delay configured for automatic extinguishing events.

The default settings are:

- Basic standard mode = On
- Basic evacuation mode = Off

To configure the actuator delay for start manual call point:



1. Set the display as shown below, and then press Enter.



The red Start MCP LED flashes fast to indicate that the configuration menu is active.

2. Select a value using the value selection buttons (2 and 4).
3. Press Enter
4. Save your changes.

The available settings for this feature are shown below.

Display	Description
	Actuator delay applies to the MCP Start.
	MCP Start activates the actuator immediately (no delay).

Extinguishing agent flow

Use this menu to configure how the control panel enters into the extinguishing released state: using extinguishing agent flow confirmation or immediately after the activation of the actuator.

The default setting does not use extinguishing agent flow confirmation: extinguishing agent flow OFF. Note that with this configuration the control panel continues to provide indications of the extinguishing agent flow for information purposes (wiring faults and activation).

If your installation requires an extinguishing agent flow signal, see “Connecting an extinguishing agent flow device” on page 12 for more information.

To configure extinguishing agent flow:

1. Set the display as shown below, and then press Enter.



The red extinguishing agent flow LED flashes fast to indicate that the configuration menu is active.

2. Select a value using the value selection buttons (2 and 4).
3. Press Enter.
4. Save your changes.

The available settings for this feature are shown below.

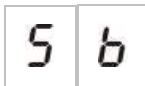
Display	Description
	Extinguishing released after extinguishing agent flow input activation.
	Extinguishing released after actuator activation. (Extinguishing agent flow indications available for information purposes)

Fire sounder operation during a zone test

Use this menu to configure the sounder operation during a zone test. The default setting for all operating modes is On.

To configure the sounder operation during a zone test:

1. Set the display as shown below, and then press Enter.



The Fire Sounders Start/Stop LED flashes fast to indicate that the sounder operation during a zone test configuration menu is active.

2. Select a value using the value selection buttons (2 and 4).
3. Press Enter.
4. Save your changes.

The available settings for this feature are shown below.

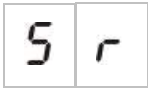
Display	Description
	The internal buzzer and sounders sound for 5 seconds when an alarm is activated in a zone test.
	The internal buzzer and sounders do not sound when an alarm is activated in a zone test.

Fire sounder re-sound

Use this menu to configure the sounder re-sound, on or off. This determines sounder operation in a fire alarm event when sounders have been silenced by pressing the Fire Sounder Start/Stop button and a new alarm event is reported in a different zone. The default setting is On.

To configure the sounder re-sound:



1. Set the display as shown below, and then press Enter.



The Sounders Start/Stop LED flashes fast to indicate that the sounder re-sound configuration menu is active.

2. Select a value using the value selection buttons (2 and 4).
3. Press Enter.
4. Save your change

The available settings for this feature are shown below.

Display	Description
	The sounders re-sound if a new fire alarm event is reported from a different zone.
	The sounders do not re-sound if a new fire alarm event is reported from a different zone.

Fire sounders silence disabled time

Note: For control panels in basic evacuation mode, any configured fire sounders silence disable times are ignored.

To prevent the immediate silencing of fire sounders when a fire alarm is first reported, the Fire Sounder Start/Stop button may be temporarily disabled for a preconfigured period of time when a configured fire sounder delay is counting down.

The disable time starts to count down when the control panel enters fire alarm status and the configured fire sounder delay starts.

During the configured disable time the Fire Sounder Start/Stop LED is off and the fire sounders cannot be silenced (before activation) by pressing the Fire Sounder Start/Stop button.

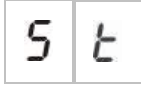
In the time between the end of the configured disable time and the end of the configured fire sounder delay (when the Fire Sounder Start/Stop LED is flashing), pressing the Fire Sounder Start/Stop button silences sounders (before activation).

A configured fire sounder delay may still be cancelled while the delay is running (and sounders activated) by pressing the Fire Sounder Delay button.

Use this menu to configure the time while fire sounders silence is disabled. The default setting is 1 minute.

To configure the Fire Sounders Silence Disabled Time:

1. Set the display as shown below, and then press Enter.



The Fire Sounders Start/Stop LED flashes fast to indicate that the Fire Sounders Silence Disable Time configuration menu is active.

2. Select a delay value from 00 to 10 minutes using the value selection buttons (2 and 4).
3. Press Enter.
4. Save your changes.

Battery fault check

Use this menu to configure the battery fault check, on or off. This determines whether the battery fault is supervised or not. The default setting is On.

Note: If disabled, it does not comply with EN 54-2 and EN 54-4.

To configure the battery fault check:

1. Set the display as shown below, and then press Enter.



The power supply fault LED flashes fast to indicate that the battery fault check menu is active.

2. Select a value using the value selection buttons (2 and 4).
3. Press Enter.
4. Save your change

The available settings for this feature are shown below.

Display	Description
	The battery fault check is enabled.
	The battery fault check is disabled.

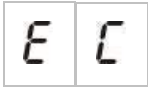
Earth fault check

Use this menu to configure the earth fault check, on or off. This determines whether the earth fault is supervised or not. The default setting is On.

Note: If disabled, it does not comply with EN 54-2 and EN 54-4.

To configure the earth fault check:

1. Set the display as shown below, and then press Enter.



The earth fault LED flashes fast to indicate that the battery fault check menu is active.

2. Select a value using the value selection buttons (2 and 4).
3. Press Enter.
4. Save your change

The available settings for this feature are shown below.

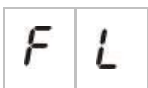
Display	Description
	The earth fault check is enabled.
	The earth fault check is disabled.

Fault latch

Use this menu to configure the fault latch, on or off. This determines whether the power supply fault is latched or not. The default setting is On.

To configure the fault latch:



1. Set the display as shown below, and then press Enter.



The general fault LED flashes fast to indicate that the fault latch menu is active.

2. Select a value using the value selection buttons (2 and 4).
3. Press Enter.
4. Save your change

The available settings for this feature are shown below.

Display	Description
	The fault latch is enabled.
	The fault latch is disabled.

Zone configuration

Use this menu to configure zone settings for each zone in your fire alarm system.

To configure the zone:

1. Set the display as shown below, and then press Enter.





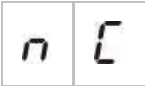


2. Select the zone (for example, zone 1), and then press Enter.





The red Zone LED flashes fast to indicate that the corresponding zone configuration menu is active.

3. Select a value using the value selection buttons (2 and 4).
4. Press Enter.
5. Save your changes.

The available settings for this feature are shown below.

Display	Description
	Passive end-of-line
	Active end-of-line
	Passive end-of-line with CleanMe
	Active end-of-line with CleanMe
	Intrinsically safe

Display	Description
	Zenner end-of-line
	Unlatched (only for BS 7273 mode and fire detection zones)

Zone delay

Use this menu to configure zone delays, on or off, for each zone in your fire alarm system. The default setting is On.

To configure the zone delay:

1. Set the display as shown below, and then press Enter.





2. Select the zone (for example, zone 1), and then press Enter.



The Zone alarm LED flashes fast to indicate that the corresponding zone configuration menu is active.

3. Select a value using the value selection buttons (2 and 4).
4. Press Enter.
5. Save your changes.

The available settings for this feature are shown below.

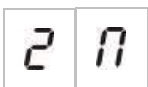
Display	Description
	Configured delays are allowed in the corresponding zone.
	Configured delays are not allowed in the corresponding zone

Zone type

Use this menu to configure the zone type for each zone in your system.

To configure the zone type:

1. Set the display as shown below, and then press Enter.






2. Select the zone (for example, zone 1), and then press Enter.



The Zone alarm LED flashes fast to indicate that the corresponding zone configuration menu is active.


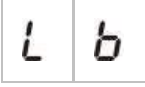

3. Select a value using the value selection buttons (2 and 4).
4. Press Enter.
5. Save your changes.

The available settings for this feature are shown below.

Display	Description
	<p>Mixed zone. The control panel automatically distinguishes between an automatic alarm (generated by a detector) and a manual alarm (generated by a manual call point fitted with a 100 Ω resistor).</p> <p>This option is not available to zones configured in the extinguishing area.</p>
	<p>Automatic zone. All fire alarms are treated as reported by a detector, even if the fire alarm is reported by a manual call point in the zone.</p> <p>This is the option applied for zones configured in the extinguishing area.</p>
	<p>Manual zone. All fire alarms are treated as reported by a manual call point, even if the fire alarm is reported by a detector in the zone.</p> <p>This option is not available to zones configured in the extinguishing area.</p>

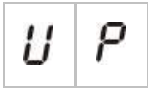
Changing user level passwords

Use the corresponding menu option (shown below) to change the default user level passwords.

	Operator user level password
	Basic installer user level password
	Advanced installer user level password

To change the first two digits of a user level password:

1. Set the display for the desired user level password, and then press Enter.
2. Set the display as shown below, and then press Enter.



3. Select a value using the value selection buttons (2 and 4).
4. Press Enter.
5. Save your changes.

To change the last two digits of a user level password:

1. Set the display for the desired user level password, and then press Enter.
2. Set the display as shown below, and then press Enter.



3. Select a value using the value selection buttons (2 and 4).
4. Press Enter.
5. Save your changes.

Auxiliary 24 V reset

Use this menu to configure the auxiliary 24 V reset setting, on or off. The default setting is OFF.

To configure the 24 V reset:

1. Set the display as shown below, and then press Enter.



2. Select a value using the value selection buttons (2 and 4).
3. Press Enter.
4. Save your changes.

The available settings for this feature are shown below.

Display	Description
	Resetting the control panel resets the AUX 24V output.
	Resetting the control panel does not reset the AUX 24V output.

Configuration, software, and PCB identification

Use the menu options shown below to see the control panel software version, configuration version, configuration date and time stamps, and the PCB serial number. For expansion boards, you can also see the software version and PCB serial number.

These details may be required for troubleshooting and technical support.

S	o	Software version
C	F	Configuration version
C	h	Configuration time stamp
C	d	Configuration date stamp
S	n	Control panel PCB serial number

The “software version” and “control panel PCB serial number” menus display a submenu that lets you select the object of interest.

F	P	Fire panel
n	A	Module A
n	b	Module B
n	C	Module C
n	d	Module D
n	b	Network board

Expansion board configuration

Adding an expansion board

Use this menu, available from the basic or advanced configuration menus, to configure the number of installed expansion boards. The default value is 00.

To add an expansion board:

1. Set the display as shown below, and then press Enter.



The Expansion I/O Fault/Disabled LED flashes fast to indicate that the module configuration menu is active.

2. Select a value using the value selection buttons (2 and 4).
Up to four expansion boards can be installed and configured.
3. Press Enter.
4. Save your changes.

Expansion board configuration

Expansion board labels

For configuration purposes expansion boards are labeled A, B, C, and D.

The label for a given module is defined by its position (left to right) in the control panel cabinet. The first expansion board installed is module A, the second B, etc.

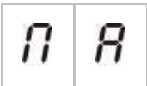

See your expansion board installation sheet for installation instructions.



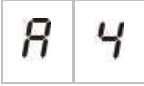
Expansion board function and delay configuration

Once an expansion board is installed and added to the control panel configuration, the following additional configuration options appear on the basic and advanced configuration menus.

Note: These configuration options are repeated for each of the installed expansion boards (A, B, C, and D).

Table 17: Expansion board A configuration options

Display	Description	Value
	Module A function	01 to 96
	Module A output 1 delay	00 to 10 minutes

Display	Description	Value
	Module A output 2 delay	00 to 10 minutes
	Module A output 3 delay	00 to 10 minutes
	Module A output 4 delay	00 to 10 minutes

Expansion board function

Use this menu to configure the expansion board function. The default value is 41. For available presets, see “Expansion board functions” on page 91.

To configure the expansion board function:

1. Set the display as shown below, and then press Enter.



The Expansion I/O Fault/Disabled LED on the control panel interface and the ON LED on the expansion board flashes fast to indicate that the module function configuration menu is active.

2. Select a value from 01 to 96 using the value selection buttons (2 and 4).
3. Press Enter.
4. Save your changes.

Expansion board output delay

Use this menu to configure an expansion board output delay of up to 10 minutes, where the feature is available.

To configure an expansion board output delay:

1. For output 1 on expansion board A, set the display as shown below, and then press Enter.



The Expansion I/O Fault/Disabled LED on the panel and the output 1 Activated LED on the expansion board flash fast to indicate that the delay menu is active.

2. Select a value from 00 to 10 minutes using the value selection buttons (2 and 4).
3. Press Enter.

4. Repeat steps 1 to 3 as required for each output (1 to 4) on each installed module (A, B, C, and D) where a delay is required.
5. Save your changes.

Fire network and repeaters configuration

This section describes how to configure a fire network of conventional control panels in order to:


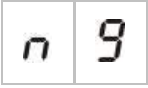
- Connect repeaters (any conventional control panel can be configured to operate as a repeater)
- Create a fire network of conventional control panels, when you need additional conventional zones in your system
- Create a network including compatible addressable control panels, to add more features to your fire detection and alarm system (for example, logging events, complex output activation controlled by the addressable system, remote monitoring)



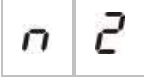
When a conventional panel is connected to a fire network it normally displays the status of one or more panels in the network (depending on repeater configuration settings). To display information for only that panel, press the Enter key for 3 seconds to provide a temporary, 30-second display of the local status indications.

Basic configuration options

The following table shows the options for creating basic fire network (Firenet) configurations.

Table 18: Basic configuration options for the fire network

Display	Description	Value
	Firenet identifier	0 to 32 0: Stand-alone (no networking) Default: 0
	Firenet group. Allows you to configure the panel to work in a 32-node network or in a group of 32 nodes inside a 250-node network	0000 to 0218 Default: 0000 The number has four digits. Identified by position, these are: 1234. Press Up to enter the first two digits of the number (positions 1 and 2). Press Down to enter the last two digits of the number (positions 3 and 4).

Display	Description	Value
	Firenet analogue remote node	0000 to 0250 Default: 0000 The number has four digits. Identified by position, these are: 1234. Press Up to enter the first two digits of the number (positions 1 and 2). Press Down to enter the last two digits of the number (positions 3 and 4).
	Firenet number of nodes [1]	2 to 32 Default: 2
	Firenet initial zone number	0001 to 9999 Default: 0001 The number has four digits. Identified by position, these are: 1234. Press Up to enter the first two digits of the number (positions 1 and 2). Press Down to enter the last two digits of the number (positions 3 and 4).

[1] Basic configuration uses consecutive numbers beginning with 1 and ending with the number entered here. Advanced configuration allows the use of specific, nonsequential node numbers. When the system has an advanced, custom pattern of node numbers, the displayed value for the number of nodes is Cu.

A basic fire network is either a panel and a repeater, or a six-zone virtual panel composed of two three-zone panels.

To configure a basic fire network:

1. Activate networking by selecting the Firenet identifier (node number) in the fire network.

The value changes from 0 to 1 for a control panel, and from 0 to 2 for a repeater panel.

If the Firenet identifier is not 0 (networking activated), a network fault is reported if the network card is not present.

The Network Fault LED blinks every 10 seconds to indicate that the panel is connected to the network without faults.

2. Select the number of control panels in the network.

This is not required when you have two panels (for example, a panel and a repeater).

If you select 5, panel IDs 1 to 5 will have to be present so as not to have a network fault indication.

Use advanced settings if you need to configure a network with other node IDs and you need specific control and repeater settings.

3. Select the initial zone in the fire network.

This is not required if the two panels will use the same zone numbers starting with zone 1 (that is, a panel and a repeater).

Zones are global. A remote zone event in a zone number which is also used in the local control panel will generate a response as if the event was generated by a local zone. Example: In a three-zone panel with initial zone 10, zones 10, 11 and 12 are available and any event in zones 10, 11 and 12 in any other control panel in the network will have the same effect in the panel as a local event on these zones.

Therefore, change this setting if you want to keep activations and indications independent in different control panels. Example: In a six-zone virtual panel, three-zone panel 1 can keep initial zone with the default value (1) and the three-zone panel 2 requires changing initial zone from 1 to 4.

Note that this setting can be used to configure control panels to repeat the status of control panels in the fire network with the zone LEDs. Consult fire network advanced configuration settings for further details.

Basic fire network configuration will have the default fire network settings or the ones previously configured in the advanced fire network configuration options.

Default fire network settings are as follows:

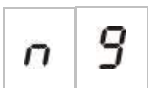
- Both control panels will control each other (fire panel and repeater panel).
- The network topology will be class B.
- The fire panel will repeat faults in the repeater panel.
- The fire panel will enter alarm and generate activations with remote zones.
- The fire panel will control its outputs (no addressable system in the network).

Firenet group

Use this menu to configure the initial node of a 32-node group inside the 250-node network, if necessary.

To configure the Firenet group:

1. Set the display as shown below, and then press Enter.



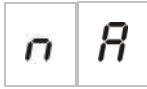
2. Select a value using the value selection buttons (2 and 4). The Network fault LED flashes fast to indicate that the Firenet group menu active.
3. Press Enter.
4. Save your changes.

Firenet analogue remote node

Use this menu to configure a remote panel out of its 32-node group inside the 250-node network.

To configure the Firenet analogue remote node:

1. Set the display as shown below, and then press Enter.



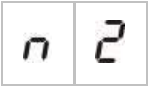
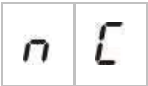
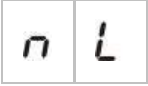
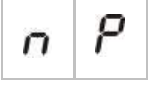
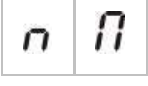
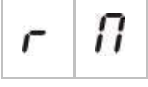
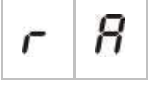

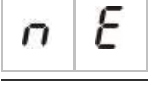
2. Select a value using the value selection buttons (2 and 4). The Network fault LED flashes fast to indicate that the Firenet analogue remote node menu is active.
3. Press Enter.
4. Save your changes.

Advanced configuration options

The following table shows the options (available to an advanced configuration user) for creating an advanced fire network configuration.

Table 19: Advanced configuration options for the fire network

Display	Description	Value
	Firenet identifier	0 to 32 0: Stand-alone (no networking) Default: 0
	Firenet group. Allows you to configure the panel to work in a 32-node network or in a group of 32 nodes inside a 250-node network	0000 to 0218 Default: 0000 The number has four digits. Identified by position, these are: 1234. Press Up to enter the first two digits of the number (positions 1 and 2). Press Down to enter the last two digits of the number (positions 3 and 4).
	Firenet analogue remote node	0000 to 0250 Default: 0000 The number has four digits. Identified by position, these are: 1234. Press Up to enter the first two digits of the number (positions 1 and 2). Press Down to enter the last two digits of the number (positions 3 and 4).
	Firenet number of nodes [1]	2 to 32 Default: 2

Display	Description	Value
	Firenet initial zone number	0001 to 9999 Default: 0001 The number has four digits. Identified by position, these are: 1234. Press Up to enter the first two digits of the number (positions 1 and 2). Press Down to enter the last two digits of the number (positions 3 and 4).
	Firenet global controls	ON/OFF Default: On
	Firenet loop class	A/B Default: B
	Process remote zones	ON/OFF Default: On
	Firenet map	01 to 32 ON/OFF On for nodes 1 and 2, off for the rest
	Firenet repeater map	01 to 32 ON/OFF On for nodes 1 and 2, off for the rest
	Firenet analogue repeater remote node	ON/OFF Default: Off
	Firenet remote output control	ON/OFF Default: Off
	Firenet extinguishing global controls	ON/OFF Default: Off

[1] The basic configuration setting can be replaced by a customized set of specific panels for communication, called a Firenet map, and a set of panels to be repeated, called a Firenet repeater map. If the configuration is changed by modifying either map, the value displayed for Firenet number of nodes is Cu (indicating a custom network configuration).

Firenet global controls

Use this menu to configure commands (for example, reset, silence/re-sound sounders, panel silence, cancelling delays) as local or global.

By default, this is On (controls are local but also sent to the network).

Note: Local or global controls does not apply to disable/enable and test commands. These are always local and sent to the control panels being repeated. This feature provides more flexibility to configure disable/enable and test of zones, sounders, fire routing, and fire protection.

Examples: If we disable zone 1 in control panel 1 and control panel 1 repeats control panel 2, the zone 1 in control panel 2 will also be disabled (shared zone completely disabled). If we disable zone 1 in control panel 1 but control panel 2 is not repeated, zone 1 in panel 2 will not be disabled. (This allows disabling only part of the shared zone).

Firenet loop class

Use this menu to configure the loop class: class A (ring) or class B (bus).

Class A is recommended to provide redundancy in communication path. Class B can only be used for repeaters without control requirements.

By default, the basic settings use class B for basic repeater functionality.

Process remote zones

Use this menu to process (or not process) remote zones in alarm.

This setting lets you decide whether the control panel enters alarm and reacts accordingly or not, with any remote zone outside its range of zones. This option lets you:

- Create large conventional systems (for example, 10, 12, 16 or more zones) where each node has different global zones to indicate only the local zone in alarm
- Create systems where alarm indications have to be local to the panel (nP should be inactive)

By default, process remote zone alarms is On.

Firenet and Firenet repeater maps

If the control panels in the system do not have all the node IDs numbered consecutively (starting from 1) or if the control panels do not repeat information from all other panels, then configure Firenet map and Firenet repeater map.

Firenet map configuration

Any control panel in the fire network can be configured to show remote zone events and react as if the events were coming from the local zones, for the zones that are within the range of the panel. The range of zones in the panel is determined with the initial zone (offset) and the control panel type. The global zone numbers can be 1 to 9999. This means a three-zone panel initial zone can be 1 to 9998 and a three-zone panel with the initial zone being 100 has a zones range from 100 to 102.

The Firenet map defines all the control panels that communicate with the configured panel. This lets you create subnetworks in the fire network. For example, if you have four panels in a fire network as follows:

- Panel ID 1 with nM active for nodes 1 and 2
- Panel ID 2 with nM active for nodes 1 and 2
- Panel ID 20 with nM active for nodes 20 and 32
- Panel ID 32 with nM active for nodes 20 and 32

Panels 1 and 2 will see each other in one sub-network and panels 20 and 32 will be each other in a different sub-network. Only a Firenet wiring open-loop fault for class A networks will be shared between the two sub-networks.

Firenet repeater map configuration

Any control panel in the fire network can repeat the information of other nodes that form part of its Firenet map.

A unique panel or several panels can be repeated at the same time (including addressable panels) by defining the Firenet repeater map.

By default, the basic setting to establish the number of nodes will set the control panel to activate in the Firenet repeater map the same control panels in the Firenet map (the control panels by default will repeat all the information of all other control panels in the fire network).

The indications will show the logic OR function of the local indication together with the same indication on other remote panels being repeated. If control panels show different status, the control panel with higher priority takes precedence (if control panel 1 has sounders on delay and control panel 2 sounders on, the indication of a third panel repeater will show sounders on).

All indications received that are not available in the repeater panel for display will be ignored.

Examples:

- A conventional repeater panel can repeat an analogue panel and many indications are not available for display.
- A two-zone control panel could be configured to repeat an eight-zone panel. Zones 3 to 8 will not be available for display.

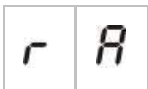
Conventional systems can be configured to repeat control panels status information instead of zones status information, in the zone LED indications.

Firenet analogue repeater remote node

Use this menu to add an analogue repeater remote node to its repeater map.



To configure the Firenet analogue repeater remote node:

1. Set the display as shown below, and then press Enter.



2. Select a value using the value selection buttons (2 and 4). The network LED flashes fast to indicate that the Firenet analogue repeater remote node menu is active.
3. Press Enter.
4. Save your changes.

The available settings for this feature are shown below.

Display	Description
	The analogue remote node is added to the repeater map.
	The analogue remote node is not added to the repeater map.

Firenet remote output control

Use this menu to configure an addressable compatible control panel in the fire network to command the outputs of the conventional panel (fire sounders, fire routing, and expansion board outputs) with advanced programming options.

Consult the addressable control panel documentation (including its configuration utility software) if you require this type of advanced configuration.

If the control panel is configured for remote output control, it will no longer activate outputs based on its own logic and will only activate outputs with commands coming from the fire network.

This mode of operation is fail-safe (if the control panel detects a fire network fault, the outputs will activate with the local logic or the remote commands).

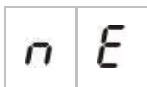
By default, Firenet remote output control is off for standalone applications or pure conventional fire networks where the control panel controls its outputs.

Firenet extinguishing global controls

Use this menu to configure extinguishing commands as local or global. By default, this is Off (remote extinguishing commands are not accepted).



To configure the Firenet extinguishing global controls:

1. Set the display as shown below, and then press Enter.



2. Select a value using the value selection buttons (2 and 4). The Network fault LED flashes fast to indicate that the Firenet menu is active.
3. Press Enter.
4. Save your changes.

The available settings for this feature are shown below.

Display	Description
	It accepts remote commands relating to the extinguishing functionality.
	It does not accept remote commands relating to the extinguishing functionality.

Commissioning

Before commissioning the control panel

Before commissioning the control panel, make sure that:

- The control panel has been correctly installed.
- The mains power is 110 VAC or 240 VAC, is connected correctly, and complies with all requirements described in “Connecting the mains power supply” on page 17.
- There are no short or open circuits in any of the zones.
- All zones have the correct end-of-line termination, as described in “Terminating zones” on page 8.
- All extinguishing devices (with special attention to the extinguishing actuator) are properly installed as described in “Connections” on page 7. Ensure that the polarity is correct and that the correct end-of-line is fitted if it is required.

Note: Observe the polarity of the extinguishing actuator output to ensure proper operation.

WARNING: Risk of death or severe injury. Test the line supervision (for open and short circuit faults) and the activation function *before* connecting the extinguishing agent to the actuator.

- Any optional equipment is correctly connected. This includes fire detection devices, fire routing, alarm and fault relays, etc.
- The batteries are connected correctly, and comply with all requirements described in “Connecting the batteries” on page 18.
- All system configuration complies with the corresponding operating mode and local regulations.

Commissioning the control panel

Once all installation, connection, and configuration requirements have been checked as described above, the control panel can be powered up.

Normal startup

After powering up the control panel, normal status (standby) is indicated as follows:

- The Supply LED is steady
- The Fire Sounder Delay LED is steady (if a delay has been configured and enabled)
- The Fire Routing Delay LED is steady (if a delay has been configured and enabled)

If any other indicators are on, check your installation thoroughly before proceeding.

Fault startup

In accordance with EN 54-2, the control panel has a special startup sequence that is used after an internal fault has been detected by the control panel.

This is indicated as follows:

- The general Fault LED flashes fast
- The System Fault LED flashes slow

When this happens:

1. Enter the operator user level password.
2. Press the Reset button to reset the control panel.

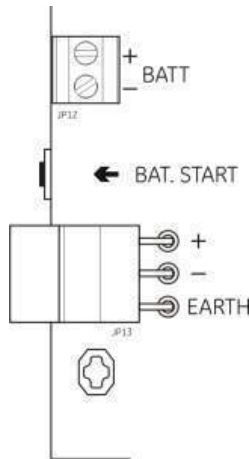
If the fault status persists after reset, the control panel aborts the startup sequence and turns on the System Fault LED.

When this happens, check all control panel connections and configuration, as described in “Before commissioning the control panel” on page 70.

Battery startup

To power up the control panel from the batteries, press the battery start button on the control panel PCB (marked as BAT. START, see Figure 19 below). Keep the button pressed for approximately 5 seconds.

Figure 19: Battery startup button



Functional tests

Create a short circuit and an open circuit in each zone to test fault reporting for both types of fault.

If available, activate a fire manual call point to test manual fire alarm reporting. The control panel should override any configured delays and activate alarm notification devices and fire routing (where applicable) immediately.

Activate a fire detector to test automatic alarm reporting. The control panel should initiate any configured delays and activate alarm notification devices and fire routing (where applicable) once the delay time has elapsed.

Verify the extinguishing functionality without connecting the extinguishing agent to the actuator. Test these functions:

- Manual (MCP Start) and automatic (extinguishing zone detectors) extinguishing activation
- Emergency override manual call points (MCP Hold and MCP Abort)
- Disabling extinguishing switch (if available)
- Extinguishing activation sounders
- Remote manual-only control and safety door monitoring (if available)
- Delay to actuator activation
- Extinguishing released sounders and optical warning panels or signs are activated by the extinguishing agent flow signal (if configured)
- Verify networking functionalities

Using a multimeter, verify that the fault relay is activated when a fault is reported and that the fire alarm relay is activated when a fire alarm is reported.

Response times

Response times for standard events are as follows.

Table 20: Response times for standard events

Event	Response time
Alarm	Less than 3 seconds
Input activation	Less than 3 seconds
MCP Hold fault	Less than 2 seconds
MCP Abort fault	Less than 2 seconds
Other input faults	Less than 3 seconds
Actuator fault	Less than 30 seconds
Optical panel fault	Less than 30 seconds
Zone fault	Less than 30 seconds
Sounder fault	Less than 30 seconds
Fire routing fault	Less than 30 seconds
Earth fault	Less than 100 seconds
Battery charger fault	Less than 100 seconds
No batteries found fault	Less than 3 minutes
Mains fault	Less than 3 minutes
Low battery fault	Less than 100 seconds
Fuse/protection fault	Less than 3 minutes
System fault	Less than 100 seconds
Battery high resistance fault	Less than 4 hours

Chapter 4

Maintenance

Summary

This chapter includes information on system maintenance and battery maintenance.

Content

System maintenance	76
Quarterly maintenance	76
Annual maintenance	76
Cleaning the control panel	76
Battery maintenance	77

System maintenance

Perform the following maintenance tasks to ensure that your fire alarm and extinguishing system works correctly and complies with all required European regulations.

WARNING: Risk of death or serious injury. Disconnect the extinguishing agent actuator from the control panel *before* you issue the actuator output test command. When you confirm the test command, the actuator output is activated immediately.

Note: Before performing any tests, ensure that fire routing (if configured) is disabled or that the fire brigade has been notified.

Quarterly maintenance

Test at least one device per zone and verify that the control panel responds to all fault and alarm events. The control panel power supply and battery voltage should be checked.

Annual maintenance

Test all system devices and verify that the control panel responds to all fault and alarm events. All electrical connections must be visually inspected to make sure that they are securely fastened, that they have not been damaged, and that they are appropriately protected.

Cleaning the control panel

Keep the outside and inside of the control panel clean. Carry out periodic cleaning using a damp cloth for the outside. Do not use products containing solvents to clean the control panel. Do not clean the inside of the cabinet with liquid products.

Battery maintenance

Compatible batteries

The control panel requires two 12V, 7.2 or 12 Ah rechargeable sealed lead-acid batteries. Compatible batteries are shown below.

Table 21: Compatible batteries

12V, 7.2 Ah	BS127N Fiamm FG20721/2 Yuasa NP7-12
12V, 12 Ah	BS130N Fiamm FG21201/2 Yuasa NP12-12

Troubleshooting batteries

Battery supply faults are indicated by a flashing Supply Fault LED. If this LED is flashing, check the following:

- That the battery cables are in good condition
- That the battery cables are connected securely and correctly at the battery and at the control panel PCB

If the cables are in good condition and all connections are correct, then the batteries should be replaced immediately.

Replacing batteries

Batteries must be replaced periodically as recommended by the battery manufacturer. The useful life of the battery is approximately four years. Avoid the total discharge of the batteries. Always use the recommended replacement batteries.

To replace the batteries:

1. Disconnect and remove the existing batteries from the cabinet.
2. Install and connect the replacement batteries using the bridge provided. Observe correct polarity.
3. Dispose of the batteries as required by local ordinances or regulations.

Chapter 5

Technical specifications

Summary

This chapter includes technical specifications for your control panel.

Content

Zone specifications 80

Input and output specifications 81

Power supply specifications 83

Mechanical and environmental specifications 84

Zone specifications

Table 22: General zone specifications

Zone output voltage	22 VDC nominal 24 VDC max. 18 VDC min.
Current consumption (per zone)	
Standby (with 32 detectors)	2.6 mA max.
Standby (with end-of-line)	7.4 mA max.
Standby (with end-of-line)	4.6 mA nominal
Short circuit	55 mA max.
Alarm	65 mA max.
Default zone configuration	Passive end-of-line
Zone termination	4.7 k Ω 5% 1/4 W end-of-line resistor (EN 54-2 and intrinsically safe modes) Active end-of-line device (BS 7273 mode) EOL-Z end of line device - polarity sensitive (EN 54-13 mode)
Number of detectors per zone	
Aritech Dx700 series	20 max.
Other detectors	32 max. [1][2]
Number of manual call points per zone	32 max. [1]

[1] Or as defined by local standards.

[2] Provided that the detectors meet the required zone specifications given here.

Table 23: Mixed zone specifications

Resistance (per zone)	40 Ω max.
Capacitance (per zone)	500 nF max.
Nominal impedance	
Detector	160 to 680 Ω \pm 5%
Manual call point	100 Ω \pm 5%
Detector alarm reference range	
Zone voltage	6.5 to 14 V
Zone impedance	145 to 680 Ω
Manual call point alarm reference range	
Zone voltage	3 to 6.5 V
Zone impedance	75 to 144 Ω
Short circuit reference range	
Zone voltage	< 3 V
Zone impedance	< 55 Ω
Open circuit reference range	
Zone impedance	> 8 k Ω
Zone device current consumption	\leq 2.6 mA

Table 24: Automatic and manual zone specifications

	EN 54-2 BS 7273	EN 54-13	Intrinsically safe
Resistance (per zone)	55 Ω max.	50 Ω max.	50 Ω max.
Capacitance (per zone)	500 nF max.	500 nF max.	500 nF max.
Nominal impedance	100 to 680 Ω \pm 5%		55 Ω max.
Detector alarm reference range			
Zone voltage	3 to 14 V		12.72 to 17.22 V
Zone impedance	75 to 680 Ω		250 to 600 Ω
Short circuit reference range			
Zone voltage	< 3 V		< 12.72 V
Zone impedance	< 55 Ω		< 80 Ω
Open circuit reference range			
Zone impedance	> 8 k Ω		> 11 k Ω
Zone device current consumption	\leq 2.6 mA		\leq 2.55 mA

Input and output specifications

Table 25: Input specifications

Number of inputs	8
Default input allocation	
IN1 (supervised)	Start extinguishing manual call point
IN2 (supervised)	Hold extinguishing manual call point
IN3 (supervised)	Abort extinguishing manual call point
	Disable extinguishing switch (BS 7273 mode)
IN4 (non-supervised)	Manual-only mode control
IN5 (supervised)	Low Pressure indication
IN6 (supervised)	Extinguishing Agent Flow
IN7 (supervised)	Safety door monitoring
IN8 (non-supervised)	Remote reset
Default input end-of-line (supervised inputs only)	15 k Ω 5% ¼ W passive end-of-line
Unsupervised inputs resistance values	
Activation input value	\leq 9 k Ω \pm 10%
Deactivation input value	> 9 k Ω \pm 10%
Supervised inputs resistance values	
Short circuit	\leq 62 Ω
Active	> 62 Ω to 8 k Ω
High impedance fault	> 8 k Ω to 10 k Ω
Standby	> 10 k Ω to 21 k Ω
Open circuit	> 21 k Ω
Control panel input current	
Standby (with end-of-line)	1.2 mA nominal
Activated	5.3 mA max.
Open circuit	100 μ A nominal
Short circuit	5.75 mA max.

Low pressure input impedance values	
Configured as normally closed	Standby: > 62 Ω to 8 k Ω Low pressure: > 10 k Ω to 21 k Ω
Configured as normally open	Standby > 10 k Ω to 21 k Ω Low pressure: > 62 Ω to 8 k Ω

Table 26: Output specifications

Number of outputs	8
Outputs functionality:	
OUT1 (non-supervised)	Hold manual call point
OUT2 (non-supervised)	Abort manual call point
OUT3 (non-supervised)	Disable extinguishing switch (BS 7273 mode)
OUT4 (non-supervised)	Manual-only mode
OUT5 (standard supervision)	Released
OUT6 (standard supervision)	Fire sounders
OUT7 (standard supervision)	Extinguishing sounders
OUT8 (extinguishing EOL supervision)	Released optical warning panels or signs Actuator
Outputs EOL (end-of-line)	
OUT1 to OUT4	Not required
OUT5 to OUT7	15 K Ω 1/4 W end-of-line resistor
OUT8	2010EXT-EOL end-of-line board
Non-supervised outputs	
Number of outputs	4 (OUT1 to OUT4)
Output type	Free-of-voltage switch (galvanic isolated)
Output inactive	open circuit
Output active	short circuit
Current rating (when switch on)	2 A max. at 30 VDC
Standard supervised outputs	
Number of outputs	3 (OUT5 to OUT7)
Output type	24 VDC supervised output
Output inactive	-10 to -13 VDC (reverse polarity supervision)
Output active	21 to 28 VDC (24 VDC nominal)
Current rating (when active)	500 mA max. at 25°C 385 mA max. at 40°C
Start-up current rating	1.35 A start-up current ($t \leq 10.5$ ms) at -5°C 1.47 A start-up current ($t \leq 8.75$ ms) at +25°C 1.57 A start-up current ($t \leq 7.70$ ms) at +50°C
Actuator output specifications	
Number of outputs	1 (OUT8)
Output type	24 VDC supervised output
Output inactive	-10 to -13 VDC (reverse polarity supervision)
Output active	21 to 28 VDC (24 VDC nominal)
Current rating (when active)	750 mA max. at 25°C 650 mA max. at 40°C
Start-up current rating	2.63 A start-up current ($t \leq 10.5$ ms) at -5°C 2.50 A start-up current ($t \leq 9.86$ ms) at 25°C 2.38 A start-up current ($t \leq 8.73$ ms) at 50°C
Alarm relay output	
Number of potential-free contacts	2 (normally-open NO and normally-closed NC)
Current rating (when active)	2 A max. at 30 VDC

Fault relay output	
Number of potential-free contacts	2 (normally-open NO and normally-closed NC)
Current rating (when active)	2 A max. at 30 VDC
Output active (energized)	No fault (short between C and NO contacts)
Auxiliary 24 VDC output	
Output voltage	21 to 28 VDC (24 VDC nominal)
Output current	250 mA max.

Power supply specifications

Table 27: Mains supply specifications

Operating voltage	110 VAC / 60 Hz or 240 VAC / 50 Hz
Rated current	
110 VAC	3.15 A
240 VAC	1.5 A
Voltage tolerance	+10% / -15%
Mains fuse	
110 VAC	T 3.15A 250V
240 VAC	T 2A 250V

Table 28: 24 VDC power supply specifications

DC voltage	24 V
Rated current	4 A
Current range	0 to 4 A
Rated power	100 W
Voltage tolerance	±2%

Table 29: Batteries and battery charger specifications

Batteries	2 × 7.2 Ah or 2 × 12 Ah
Battery type	Sealed lead-acid
Battery charger voltage	27.3 V at 20°C -36 mV/°C
Battery charger current	0.7 A max.
Out of service voltage level	< 22.75 V
No operation voltage level	< 21 V

Table 30: Expansion board current consumption [1]

Number of expansion boards	Up to 4
2010-1-SB output specifications	
Number of outputs	4 (OUT1 to OUT4)
Output type	24 VDC supervised output
Output inactive	-10 to -13 VDC (reverse polarity supervision)
Output active	21 to 28 VDC (24 VDC nominal)
Current rating (when active)	250 mA max.
Current consumption (standby)	15 mA at 24 VDC
Internal power mode current rating	300 mA max for all expansion boards
External power mode current rating	1 A max per expansion board
2010-1-RB output specifications	
Number of outputs	4 (OUT1 to OUT4)
Output type	Free-of-voltage relay
Number of potential-free contacts	2 (normally-open NO and normally-closed NC)
Current rating (when active)	2 A max. at 30 VDC
Current consumption (standby)	15 mA at 24 VDC
Current consumption (active)	50 mA (all outputs) at 24 VDC

[1] Optional expansion board not supplied with control panel.

Table 31: Power supply equipment specifications for EN 54-4

Current consumption (I _{min}) [1]	0.05 A min.
Current consumption in standby (I _{min a})	0.39 A max.
Current consumption in alarm (I _{max b})	2.78 A max.

[1] All zones and inputs in standby, no outputs activated, no expansion boards installed, no 24V auxiliary used and batteries fully charged.

Mechanical and environmental specifications

Table 32: Mechanical specifications

Cabinet dimensions without cover	421 × 100 × 447 mm
Weight without batteries	3.9 kg
Number of cable knockouts	20 × Ø 20 mm at top of cabinet 2 × Ø 20 mm at bottom of cabinet 26 × Ø 20 mm at rear of cabinet
IP rating	IP30

Table 33: Environmental specifications

Environmental class	Class A
Operating temperature	-5 to +40°C
Storage temperature	-20 to +70°C
Relative humidity	10 to 95% noncondensing
Type class conditions	3K5 of IEC 60721-3-3

Figure 20: Control panel cabinet without cover

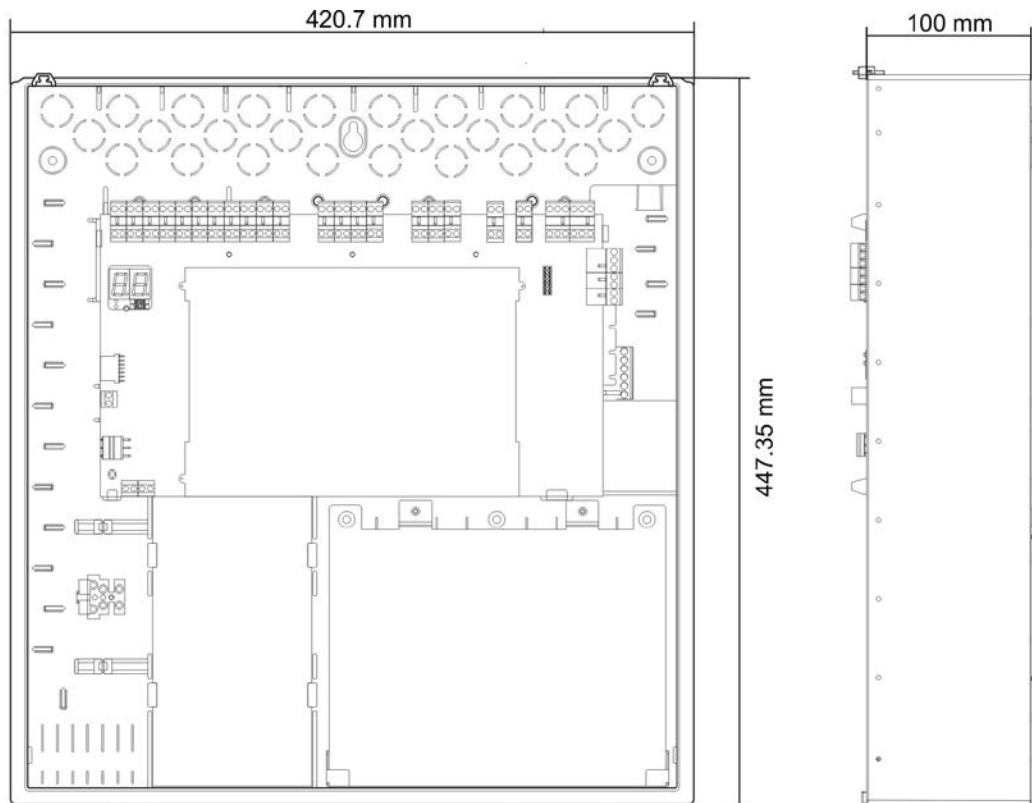
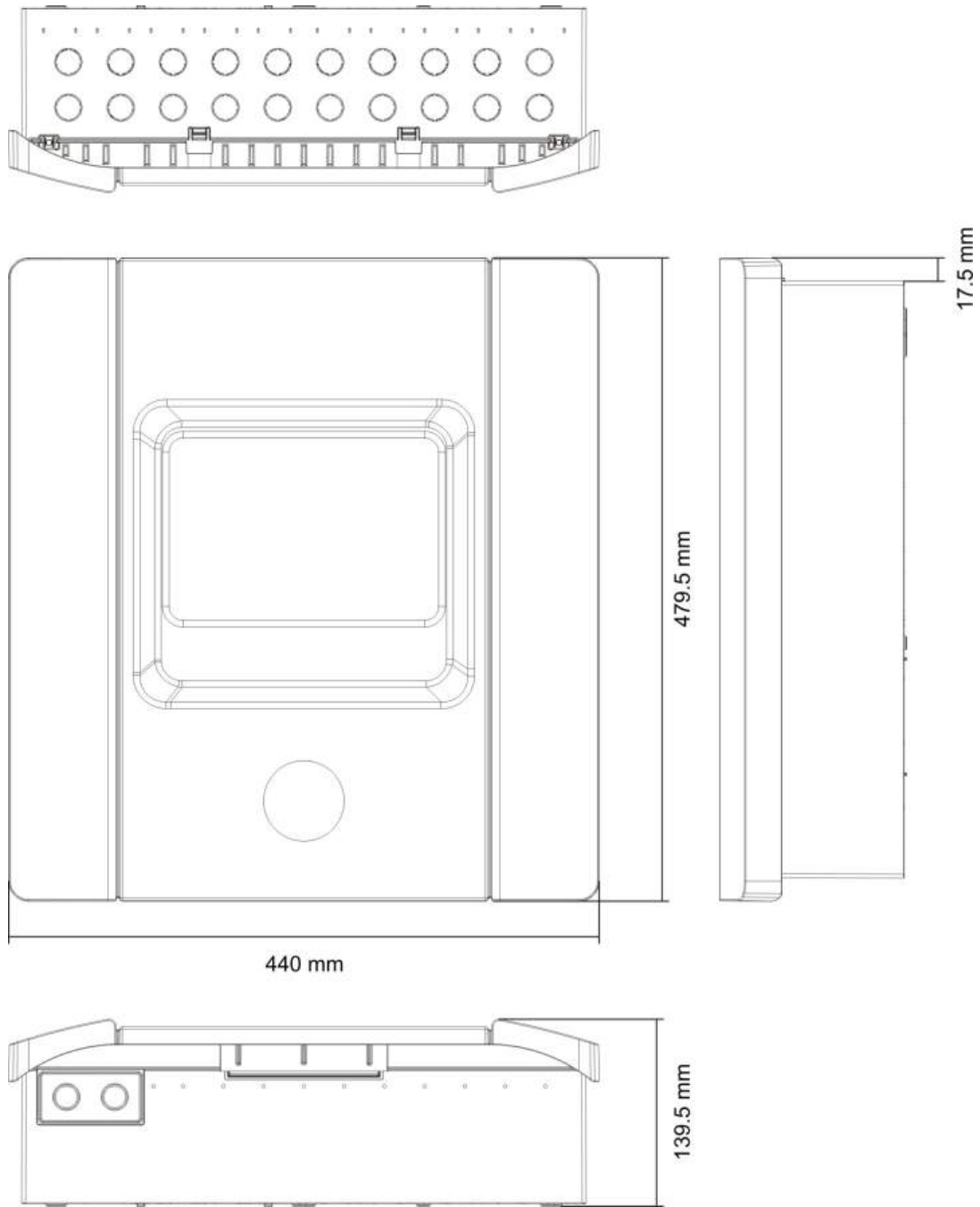


Figure 21: Control panel cabinet with cover



Appendix A

Configuration presets

Summary

This section includes detailed information on operating mode and expansion board configuration presets.

Content

Input and output configuration 88

Default delays 88

Basic configuration modes 89

 EN 54-2 supervision and Class B fire outputs 89

 EN 54-13 supervision and Class A expansion board outputs 90

Expansion board functions 91

 EN 54-2 supervision and Class B outputs 91

 EN 54-13 supervision and Class A expansion board outputs 94

Input and output configuration

Table 34: Inputs and outputs

IN1	Start MCP	Supervised
IN2	Hold MCP	Supervised
IN3	Abort MCP Disable extinguishing switch (BS 7273 mode)	Supervised Supervised
IN4	Manual-only mode activation	Unsupervised
IN5	Low pressure indication	Supervised
IN6	Extinguishing agent flow	Supervised
IN7	Safety door fault monitor	Supervised
IN8	Remote reset	Unsupervised
OUT1	Hold MCP	Unsupervised
OUT2	Abort MCP Disable extinguishing switch (BS 7273 mode)	Unsupervised Unsupervised
OUT3	Manual-only mode	Unsupervised
OUT4	Extinguishing released	Unsupervised
OUT5	Fire sounders	Supervised
OUT6	Extinguishing sounders	Supervised
OUT7	Extinguishing released optical warning panels or signs	Supervised
OUT8	Actuator	Supervised

Default delays

Table 35: Default delay configuration

Fire sounders delay	0
Fire routing delay [1]	0
Zone delay	0n
Released delay	10 seconds
Flooding time	Off
Reset disabled delay	2 minutes

[1] Requires installation of optional 2010-1-SB expansion board (not supplied).

Basic configuration modes

EN 54-2 supervision and Class B fire outputs

Note: The following presets are available for installations that do not use EN 54-13 supervision (the SU setting is Of). See “Supervision mode” on page 33 for more information.

Basic standard mode

Fire sounders cannot be manually activated in this operating mode (fire sounders are only activated if there is a fire alarm).

The configured actuator delay is applied when the MCP Start is activated.

Table 36: Presets and zone characteristics

Preset	Zone description	Zone detection
01	Passive EOL	Z1 and Z2 automatic, for extinguishing event Z3 mixed, for fire detection
02	Passive EOL, CleanMe enabled	Z1 and Z2 automatic, for extinguishing event Z3 mixed, for fire detection

Basic evacuation mode

Fire sounders can be manually activated at the operator user level in this operating mode (a fire alarm is not required).

The actuator is activated immediately when the MCP Start is activated.

Table 37: Presets and zone characteristics

Preset	Zone description	Zone detection
05	Passive EOL	Z1 and Z2 automatic, for extinguishing event Z3 mixed, for fire detection
06	Passive EOL, CleanMe enabled	Z1 and Z2 automatic, for extinguishing event Z3 mixed, for fire detection

BS 7273 mode stage 1

Fire sounders cannot be manually activated. Fire sounders are off during the sounders delay.

Table 38: Presets and zone characteristics

Preset	Zone description	Zone detection
11	Active EOL	Z1 and Z2 automatic, for extinguishing event Z3 mixed, for fire detection
12	Active EOL, CleanMe enabled	Z1 and Z2 automatic, for extinguishing event Z3 mixed, for fire detection

BS 7273 mode stage 2

Fire sounders cannot be manually activated. Fire sounders activated intermittently during the sounders delay.

Table 39: Presets and zone characteristics

Preset	Zone description	Zone detection
13	Active EOL	Z1 and Z2 automatic, for extinguishing event Z3 mixed, for fire detection
14	Active EOL, CleanMe enabled	Z1 and Z2 automatic, for extinguishing event Z3 mixed, for fire detection

Repeater with fire routing (EN 54-2)

All input/output supervision is disabled. No fire and extinguishing functionality.

Table 40: Presets and zone characteristics

Preset	Zone description	Zone detection
61	Not used	Not used

Repeater with fire routing (BS 7273)

All input/output supervision is disabled. No fire and extinguishing functionality.

Table 41: Presets and zone characteristics

Preset	Zone description	Zone detection
63	Not used	Not used

EN 54-13 supervision and Class A expansion board outputs

Note: The following presets are available for installations that use EN 54-13 supervision (the SU setting is A). See “Supervision mode” on page 33 for more information.

Basic standard mode

Fire sounders cannot be manually activated in this operating mode (fire sounders are only activated if there is a fire alarm).

The configured actuator delay is applied when the MCP Start is activated.

Table 42: Presets and zone characteristics

Preset	Zone description	Zone detection
01	EN 54-13 EOL	Z1 and Z2 automatic, for extinguishing event Z3 mixed, for fire detection

Basic evacuation mode

Fire sounders can be manually activated at the operator user level in this operating mode (a fire alarm is not required).

The actuator is activated immediately when the MCP Start is activated.

Table 43: Presets and zone characteristics

Preset	Zone description	Zone detection
05	EN 54-13 EOL	Z1 and Z2 automatic, for extinguishing event Z3 mixed, for fire detection

Expansion board functions

EN 54-2 supervision and Class B outputs

Note: The following expansion board presets are available for installations that do not use EN 54-13 supervision (the SU setting is Of). See “Supervision mode” on page 33 for more information.

Table 44: Expansion board functions (EN 54-2, Class B outputs)

Preset	ON status	Output	Delay
01	Z1 alarm	1	Yes
	Z2 alarm	2	Yes
	Z3 alarm	3	Yes
05	Z1 alarm	1	Yes
		2	Yes
	Z2 alarm	3	Yes
		4	Yes
06	Z3 alarm	1	Yes
		2	Yes
22	Z1 and Z2 alarm	1	Yes
		2	Yes
	Z2 and Z3 alarm	3	Yes
		4	Yes
23	Z1 or Z2 alarm	1	Yes
		2	Yes
	Z2 or Z3 alarm	3	Yes
		4	Yes

Preset	ON status	Output	Delay
24	Fire alarm	1	No
		2	No
		3	No
		4	No
25	Fault	1	No
		2	No
		3	No
		4	No
26	Fire alarm	1	No
		2	No
	Fault	3	No
		4	No
27	Fire alarm	1	No
	Fault	2	No
	Buzzer ON	3	No
	Reset ON	4	No
29	Fault [1]	1	No
		2	No
		3	No
		4	No
30	Fire alarm	1	No
		2	No
	Fault [1]	3	No
		4	No
31	Fire alarm	1	No
	Fault [1]	2	No
	Buzzer ON	3	No
	Reset ON	4	No
33	Buzzer ON	1	No
		2	No
	Reset ON	3	No
		4	No
41	Fire alarm	1	Yes
	Extinguishing activation	2	Yes
	Extinguishing preactivation	3	Yes
	Extinguishing released	4	Yes

Preset	ON status	Output	Delay
42	Hold ON	1	Yes
	Abort ON	2	Yes
	Manual-only mode	3	Yes
	Manual-automatic mode	4	Yes
43	Extinguishing activation disabled	1	Yes
	Pressure low fault	2	Yes
	Safety door fault	3	Yes
	Extinguishing agent flow ON	4	Yes
44	Extinguishing activation	1	Yes
		2	Yes
	Extinguishing released	3	Yes
		4	Yes
45	Fire sounders [2]	1	Yes
	Extinguishing sounders [2]	2	Yes
	Extinguishing released optical warning [2]	3	Yes
	Actuator ON [2]	4	Yes
46	Fire alarm	1	No
		2	No
	Activated	3	No
		4	No
47	Pre-activated	1,2	No
	Released	3,4	No
48	Hold on	1,2	No
	Abort on	3,4	No
49	Manual mode	1,2	No
	Automatic mode	3,4	No
50	Extinguishing disabled	1,2	No
	Pressure switch fault	3,4	No
51	Door fault	1,2	No
	Gas Flow on	3,4	No
52	Fire sounders [3]	1,2	No
	Extinguishing sounders [3]	3,4	No
53	Optical panel [3]	1,2	No
	Actuator [3]	3,4	No
55	Actuator blocked	1,2,3,4	No

Preset	ON status	Output	Delay
80	Fire routing ON	1	No
		2	No
		3	No
		4	No
90	Fire Sounders ON	1	No
		2	No
	Extinguishing sounders ON [4]	3	No
		4	No
91	Fire Sounders ON	1	No
		2	No
		3	No
		4	No
92	Extinguishing sounders ON	1	No
		2	No
		3	No
		4	No
96	Extinguishing activation sounders ON [3]	1	No
		2	No
	Extinguishing released sounders ON [3]	3	No
		4	No

[1] Fail-safe mode (output is active when there is no fault).

[2] Faults and disable options are linked to the expansion board indications.

[3] Not considered to signal supervision faults and linked to the expansion I/O indications.

[4] Faults are signaled in the Extinguishing Sounders LED. Output activates continuously and the tone (for activation or released) has to be provided and configured in the sounder device.

EN 54-13 supervision and Class A expansion board outputs

Note: The following presets are available for installations that use EN 54-13 supervision (the SU setting is A). See “Supervision mode” on page 33 for more information.

Table 45: Expansion board functions (EN 54-13, Class A outputs)

Preset	ON status	Output	Delay
05	Z1 alarm	1	Yes
		2	Yes
	Z2 alarm	3	Yes
		4	Yes

Preset	ON status	Output	Delay
06	Z3 alarm	1	Yes
		2	Yes
22	Z1 and Z2 alarm	1	Yes
		2	Yes
	Z2 and Z3 alarm	3	Yes
		4	Yes
23	Z1 or Z2 alarm	1	Yes
		2	Yes
	Z2 or Z3 alarm	3	Yes
		4	Yes
24	Fire alarm	1	No
		2	No
		3	No
		4	No
25	Fault	1	No
		2	No
		3	No
		4	No
26	Fire alarm	1	No
		2	No
	Fault	3	No
		4	No
29	Fault [1]	1	No
		2	No
		3	No
		4	No
30	Fire alarm	1	No
		2	No
	Fault [1]	3	No
		4	No
33	Buzzer ON	1	No
		2	No
	Reset ON	3	No
		4	No

Preset	ON status	Output	Delay
44	Extinguishing activation	1	Yes
		2	Yes
	Extinguishing released	3	Yes
		4	Yes
46	Fire alarm	1	No
		2	No
	Activated	3	No
		4	No
47	Pre-activated	1,2	No
	Released	3,4	No
48	Hold on	1,2	No
	Abort on	3,4	No
49	Manual mode	1,2	No
	Automatic mode	3,4	No
50	Extinguishing disabled	1,2	No
	Pressure switch fault	3,4	No
51	Door fault	1,2	No
	Gas Flow on	3,4	No
52	Fire sounders [3]	1,2	No
	Extinguishing sounders [3]	3,4	No
53	Optical panel [3]	1,2	No
	Actuator [3]	3,4	No
55	Actuator blocked	1,2,3,4	No
80	Fire routing ON	1	No
		2	No
		3	No
		4	No
90	Fire Sounders ON	1	No
		2	No
	Extinguishing sounders ON [4]	3	No
		4	No
91	Fire Sounders ON	1	No
		2	No
		3	No
		4	No

Preset	ON status	Output	Delay
92	Extinguishing sounders ON	1	No
		2	No
		3	No
		4	No
96	Extinguishing activation sounders ON [4]	1	No
		2	No
	Extinguishing released sounders ON [4]	3	No
		4	No

[1] Fail-safe mode (output is active when there is no fault).

[2] Faults and disable options are linked to the expansion board indications.

[3] Not considered to signal supervision faults and linked to the expansion board indications.

[4] Faults are signaled in the Extinguishing Sounders LED. Output activates continuously and the tone (for activation or released) has to be provided and configured in the sounder device.

Appendix B

Regulatory information

Summary

This section includes regulatory information for your control panel.

Content

European standards 100
Declared performance 101
Electrical safety 101

European standards

European standards for fire control and indicating equipment

These control panels have been designed in accordance with European Standards EN 54-2, EN 54-4, and EN 12094-1.

In addition, all models comply with the following EN 54-2 and EN 12094-1 optional requirements.

Table 46: EN 54-2 optional requirements

Option	Description
7.8	Output to fire alarm devices [1]
7.9	Control of fire alarm routing equipment
7.9.1	Output to fire alarm routing equipment [2]
7.10	Output to fire protection equipment
7.11	Delays to outputs
7.12	Co-incident detection, Type C only
8.3	Fault signals from points
8.4	Total loss of power supply
10	Test condition

[1] Inputs and outputs on the optional 2010-1-SB expansion board do *not* support the optional requirement of EN 54-2 clause 7.8 and should not be used for fire alarm devices.

[2] Requires installation of optional 2010-1-SB expansion board (not supplied).

Table 47: EN 12094-1 optional requirements

Option	Description
4.17	Delay release of extinguishing agent
4.18	Indication of extinguishing agent flow
4.19	Monitor component status
4.20	Emergency hold device (mode A or B)
4.21	Control of flooding time
4.23	Manual mode
4.24	Trigger signals to equipment within the system
4.26	Trigger signals to equipment outside the system
4.27	Emergency abort device
4.30	Activate alarm devices with different signals

Declared performance

European regulations for construction products

This section includes both regulatory information and a summary on the declared performance according to the Construction Products Regulation 305/2011. For detailed information refer to the product Declaration of Performance (DoP).

Table 48: Regulatory information

Certification	CE
Certification body	0370
Manufacturer	UTC CCS Manufacturing Polska Sp. Z o.o. Ul. Kolejowa 24. 39-100 Ropczyce, Poland Authorized EU manufacturing representative: UTC Fire & Security B.V., Kelvinstraat 7,6003 DH Weert, The Netherlands
Year of first CE marking	13
Declaration of Performance number	360-3117-1999
EN 54	EN 54-2:1997 + AC:1999 + A1:2006 EN 54-4:1997 + AC:1999 + A1:2002 + A2:2006 EN 12094-1:2003
Product identification	See model number on product identification label
Intended use	See DoP point 3
Essential characteristics	See DoP point 9

Electrical safety

European standards for electrical safety and electromagnetic compatibility

These control panels have been designed in accordance with the following European standards for electrical safety and electromagnetic compatibility:

- EN 60950-1
- EN 50130-4
- EN 61000-6-3
- EN 61000-3-2
- EN 61000-3-3

Index

A

auxiliary 24 V reset, 56

B

battery

- compatible batteries, 75
- connections, 17
- fault check, 51
- maintenance, 75
- replacement, 75
- troubleshooting, 75

C

cabinet

- layout, 4
- wall mounting, 5

cables, recommended, 7

commissioning

- battery startup, 70
- checklist, 68
- fault startup, 69
- normal startup, 69

configuration

- advanced, 35
- basic, 29
- common tasks, 27
- expansion board, 58
- fire network and repeaters, 60
- Firenet and Firenet repeater maps, 65
- zone, 53

configuration identification, 57

configuration presets

- basic, EN 54-13, 88
- basic, EN 54-2, 87
- delays, 86
- expansion boards, EN 54-13, 92
- expansion boards, EN 54-2, 89
- input and output, 86

connections

- alarm and fault relays, 19
- auxiliary equipment, 18
- battery, 17
- disable extinguishing switch, 12
- expansion boards, 19
- extinguishing actuator output, 15

extinguishing agent flow device, 12

extinguishing MCP, 11

fire detectors, 9

fire MCP, 9

fire network, 19

inputs, 10

low pressure indication switch, 12

mains power supply, 16

manual-only mode control device, 12

outputs, 14

remote reset device, 14

safety door fault monitoring device, 13

zone, 8

D

delays

- actuator, 32
- actuator for Start MCP, 48
- configuration presets, 86
- fire routing, 34
- fire sounders, 33
- reset disabled, 33
- safety door fault delay, 40
- zone, 54

E

earth fault check, 52

extinguishing agent flow, 48

F

fault latch, 52

fire network connections, 19

fire sounder

operation during a zone test, 49

re-sound, 50

silence disabled time, 50

flooding time, 46, 47

functional tests, 70

H

hold mode, MCP, 41

I

input

- configuration presets, 86
- connections, 10
- functionality, 10
- termination, 10

interface controls, 25

M

mains power supply, 16

maintenance

- battery, 75
- fire system, 74

manual key mode, 45

manual-only mode local, 44

MCP hold mode, 41

menu

- advanced configuration, 35
- basic configuration, 29

O

operating modes, 2

output

- configuration presets, 86
- connections, 14
- functionality, 14
- termination, 15

P

password change, 55

pressure switch type, 41

product compatibility, 2

R

response times, 71

S

safety door

- fault delay, 40
- monitoring, 40

seven-segment display, 26

T

tone

- activation, 42
- released, 42

U

user interface

- BS 7273, 24
- standard, 23

user levels, 24

- passwords and indications, 25

Z

zone

- configuration, 7, 53
- connections, 8
- extinguishing, 43
- line resistance, 8
- termination, 8
- type, 54

